



RX II Series User Manual



<http://www.GCCworld.com>

NOTICE

GCC reserves the right to modify the information contained in this user manual at any time without prior notice; un-authorized modification, copying distribution or display is prohibited. All comments, queries or suggestions concerning this manual please consult with your local dealer.

Important Information

Thank you for purchasing the **GCC RX II Series Cutting Plotter**.

Before you use the cutting plotter, please make sure that you have read the safety precautions and instructions below.



Caution

SAFETY PRECAUTIONS!

- For safety concern, please always hold the cutter firmly **from the bottom** while moving it. Do not move the cutter by clasping the depression area on both sides.

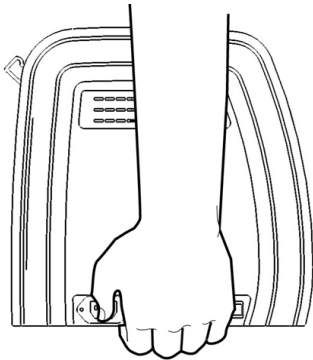

O (Correct)

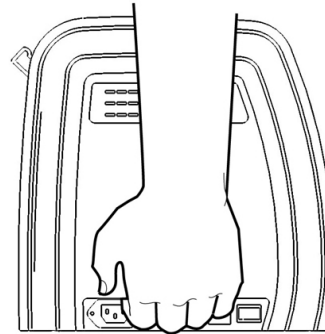

X (Incorrect)

- Do not shake or drop the blade holder, a blade tip can fly out.
- During an operation, do not touch any of the moving parts of this machine (such as the carriage). Also be careful to make sure that clothing and hair do not get caught.
- Always connect the power cable to a grounded outlet.
- Always use the accessory power cable which is provided. Do not wire the power cable so that it becomes bent or caught between objects.
- Do not connect the power cable to branching outlet to which other machines are also connected, or use an extension cable. There is danger of overheating and of mis-operation of the machine.
- Keep the tools away from children where they can reach.
- Always put the pinch rollers within the white marks.

Warning

Never press the top release grip and pull the bottom release grip at the same time as the pictures shown below:

O (CORRECT)

Press down

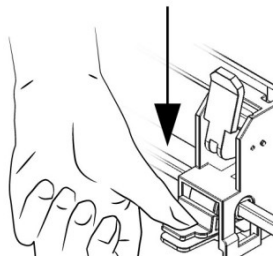

DISABLE

X (INCORRECT)

Press down

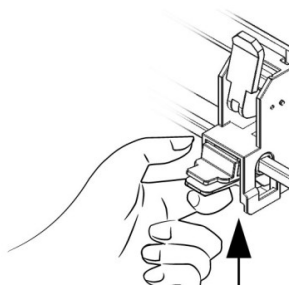
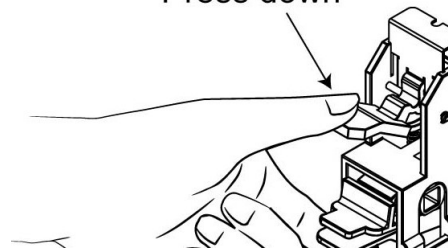

Pull up bottom to release grip

ENABLE

Note:

In case the grips clipped together due to your wrong operation, please use a pair of tweezers to pull out the stop bar when pressing down the top release grip. Keep the stop bar outside then release the grips as the right figure.

Table of Contents

Important Information

1. General Information

1.1	Introduction	1-1
1.2	Package Items	1-1
1.3	Product Features	1-2
1.4	Appearance of RX II series	
1.4.1	The Front View	1-3
1.4.2	The Back View	1-4
1.4.3	The Whole View	1-5
1.4.4	The Left-hand Side	1-6
1.4.5	The Right-hand Side	1-6
1.4.6	The Pinch Roller	1-7

2. Installation

2.1	Precaution	2-1
2.2	Stand & Flexible Media Support System	2-2
2.3	USB Cable Tie and Saddle	2-7
2.4	Desktop Flexible Media Support System	2-9
2.5	Instruction of Damper Roller	2-11
2.6	Blade and Blade Holder Installation	2-12
2.6.1	Blade Installation	2-12
2.6.2	Blade Holder Installation	2-13
2.6.3	Extension Holder Installation	2-14
2.7	Automatic Blade Length Detection	2-16
2.8	Cable Connections	2-18
2.8.1	USB Interface	2-18
2.8.1.1	Connecting your GCC cutter	2-18
2.8.1.2	Installing the driver	2-18
2.8.1.3	Driver Un-installation	2-23
2.8.2	RS-232 Interface	2-27
2.8.3	Ethernet Connection	2-27
2.8.4	Data Transmitting	2-31
2.8.5	Printer Sever Shared Setting	2-32
2.9	Software Installation	2-35
2.9.1	GreatCut-S Installation	2-35
2.9.1.1	Auto Installation	2-35
2.9.1.2	Manual Activation	2-40
2.9.1.3	Re-install GreatCut-S Software	2-42
2.9.1.4	Reset GreatCut-S Serial Code	2-42
2.9.2	SmartCUT Installation	2-43
2.10	Auto Cut-off system Installation	2-44

3. The Control Panel

3.1	The LCD Panel	3-1
3.2	Menu in On-line Mode	3-3
3.3	Menu in Off-line Mode	3-4
3.4	Menu Items	3-6

4. Operation

4.1	Media Loading	4-1
4.1.1	Loading the Sheet Media	4-1
4.1.2	Loading the Roll Media	4-3
4.2	Tracking Performance	4-6
4.3	Cutting Force and Offset Adjustment	4-7
4.4	How to Cut 3mm Letter	4-8
4.5	How to Make A Long Plot	4-8
4.6	When Completing the Cutting Job	4-9
4.7	RX II series Print Driver setting	
4.7.1	RX II series Print Driver setting > Option Page	4-10
4.7.2	RX II series Print Driver setting > Pen Page	4-13
4.7.3	RX II series Print Driver setting > Paper Page	4-17
4.8	How to set die/kiss cut through plug-in software for Adobe Illustrator and CorelDraw	4-18
4.9	How to create a file for cutting with barcode function	4-21
4.10	Reference Parameter Setting for Different Materials	4-29

5. Automatic-Aligning System

5.1	Introduction	5-1
5.2	AAS Contour Cutting System	5-2
5.2.1	Notice for Registration Marks	5-2
5.2.2	AAS II on RX II series	5-3
5.2.3	Automatic Distinction of the Plot Direction	5-5
5.3	Printer Test	5-6
5.4	Registration Mark Offset Range	5-8
5.5	Contour Cutting	5-8
5.6	Tips for AAS	5-10

6. Maintenance

6.1	Cleaning the cutting Plotter	6-1
6.2	Cleaning the Grid Drum	6-2
6.3	Cleaning the Pinch Rollers	6-2

7. Trouble Shooting

7.1	Non-Operational Problems	7-1
7.2	Operational Problems	7-2
7.3	Communication Problems	7-3
7.4	Software Problems	7-4
7.5	Cutting Quality Problem	7-5
7.6	USB Connection Problems	7-6

Appendix

A-1	RX II Series Specification	A-1
A-2	Blade Specification	A-2
A-3	CorelDRAW Output Instruction	A-3
A-4	CorelDRAW Plug-In Instruction	A-4
A-5	Illustrator Plug-In Instruction	A-5
A-6	Greatcut-S quick manual	A-6

Chapter 1 General Information

1.1 Introduction

RX II series cutting plotters have been designed to produce computer-generated images or perform contour cutting on sheets or rolls of vinyl media.

This manual covers the following models of RX II series cutting plotters:

· RX II-61	for media width: 50mm (1.97") ~ 810mm (31.88")
· RX II-101S	for media width: 50mm (1.97") ~ 1326mm (52.2")
· RX II-132S	for media width: 50mm (1.97") ~ 1635mm (64.37")
· RX II-183S	for media width: 50mm (1.97") ~ 2145mm (84.44")

1.2 Package Items

The package of the RX II series contents the items listed below, please check carefully.

If you find any item missing, please consult your local dealer for further assistance.

Standard Item	Quantity
1. Cutting Plotter	1
2. Stand Set (for RX II-101S/132S/183S only)(Optional for RX II-61)	1
● 2 piece of T-shape stand	
● 1 piece of stand beam	
● 18 pieces of M6 screws	
● 1 piece of M5 L-shape hexagon screw driver	
● 1 piece of Installation Guide for Stand Set	

3. Flexible Media Support System Package			1
Items	183S/132S/101S	61	
1 set of Roll Media Flange (2 pieces)	V	V	
1 set of Roll Holder (2 pieces)	V	V	
1 set of Roll Holder Guide Bushes (4 pieces)	V	V	
1 set of Roll Holder Support (2 pieces)	V	V	
1 piece of M6 L-shape hexagon screw driver	V	V	
1 piece of Installation Guide for Roll Holder		V	
1 piece of M5 L-shape hexagon screw driver		V	
1 set of Desktop Support Brackets (2 pieces)		V	
4 pieces of Plastic Foot		V	
4 pieces of M4 screws		V	
12 pieces of M6 screws		V	
1 piece of M4 L-shape hexagon screw driver		V	
4. Accessories			1
● 1 piece of AC power Cord			
● 1 piece of data cable (USB cable: 3m)			
● 1 piece of Ethernet cable			
● 1 set of Blade Holder Assembly (Installed in tool carriage of the cutting plotter)			
● 1 piece of Blade (Installed in Blade Holder)			
● 1 piece of Safe Blade			
● 1 piece of Cutting Pad for Vinyl cutting			
● 1 piece of Tweezers			
● 1 piece of Promise Card			

1.3 Product Features

The following are the main features of the RX II series cutting plotters:

- Triple port (USB, serial and Ethernet port) connectivity
- Up to 600-gram cutting force
- Up to 1530 mm per second (60 ips) cutting speed (at 45° direction)
- Can work with up to 0.8mm (0.03in) thick material
- Guaranty 10-meter tracking
- User friendly and multi-language control panel
- Enhanced Automatic-Aligning System (AAS II) for automatic contour cutting
- Ingenious media basket (optional item)

1.4 Appearance of RX II Series

1.4.1 The Front View (Figure 1-1)

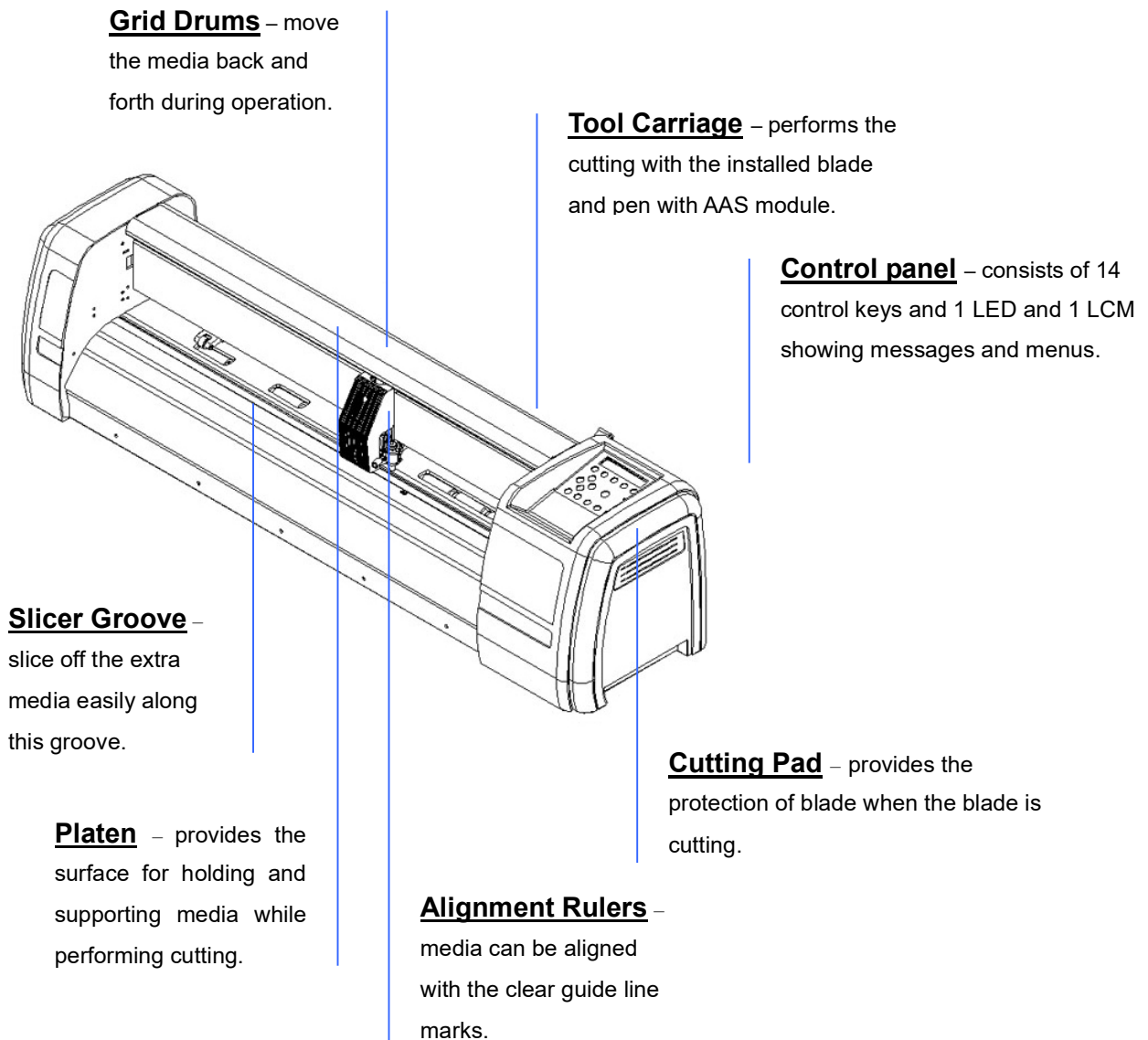
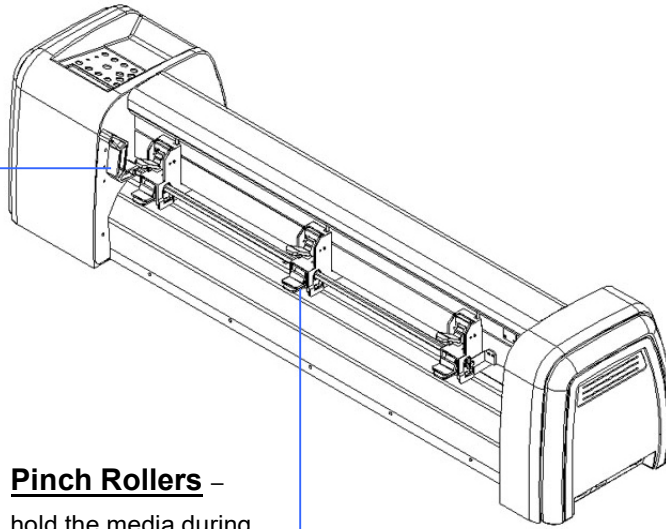

Figure 1-1

1.4.2 The Back View (Figure 1-2)

Lever –

raises or lowers the
pinch rollers.



Pinch Rollers –

hold the media during
cutting.

Figure 1-2

1.4.3 The Whole View of RX II Series (Figure 1-3)

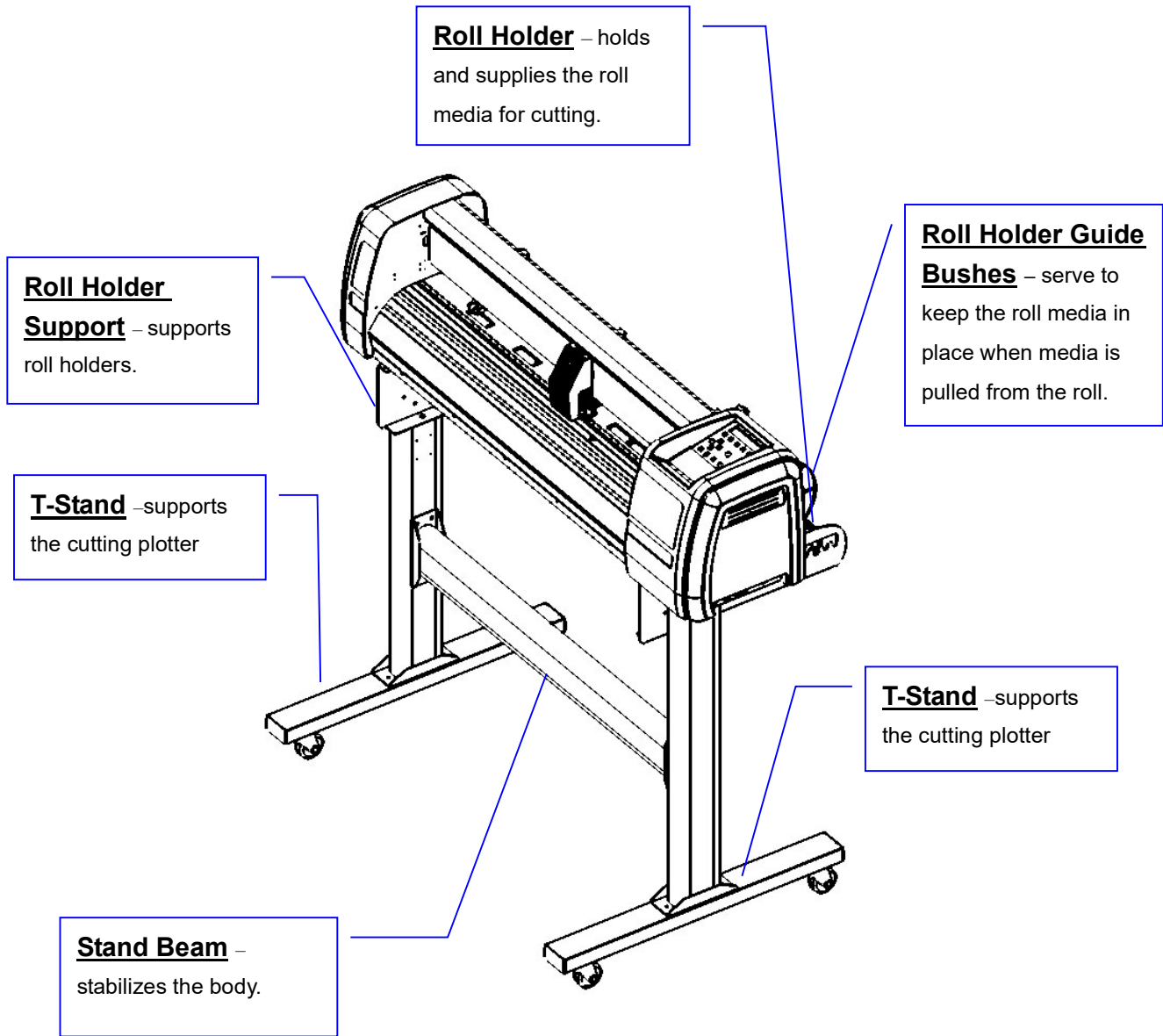
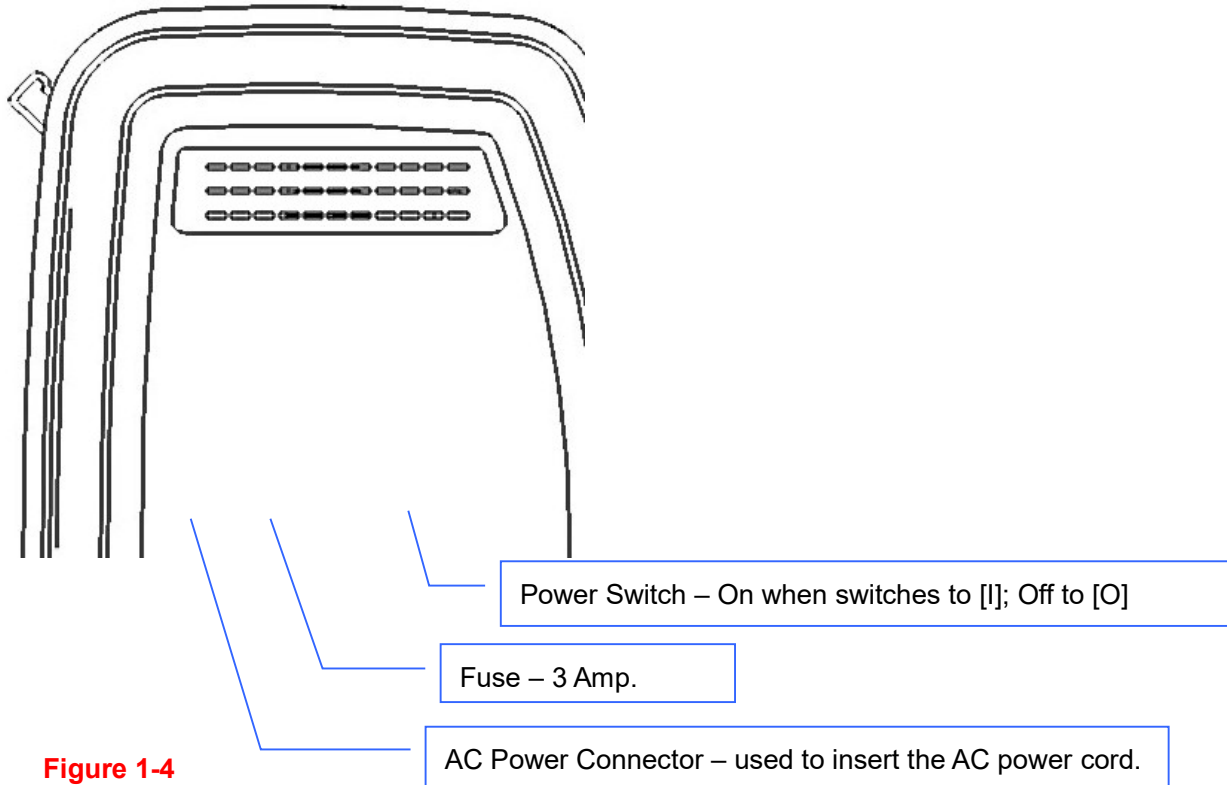
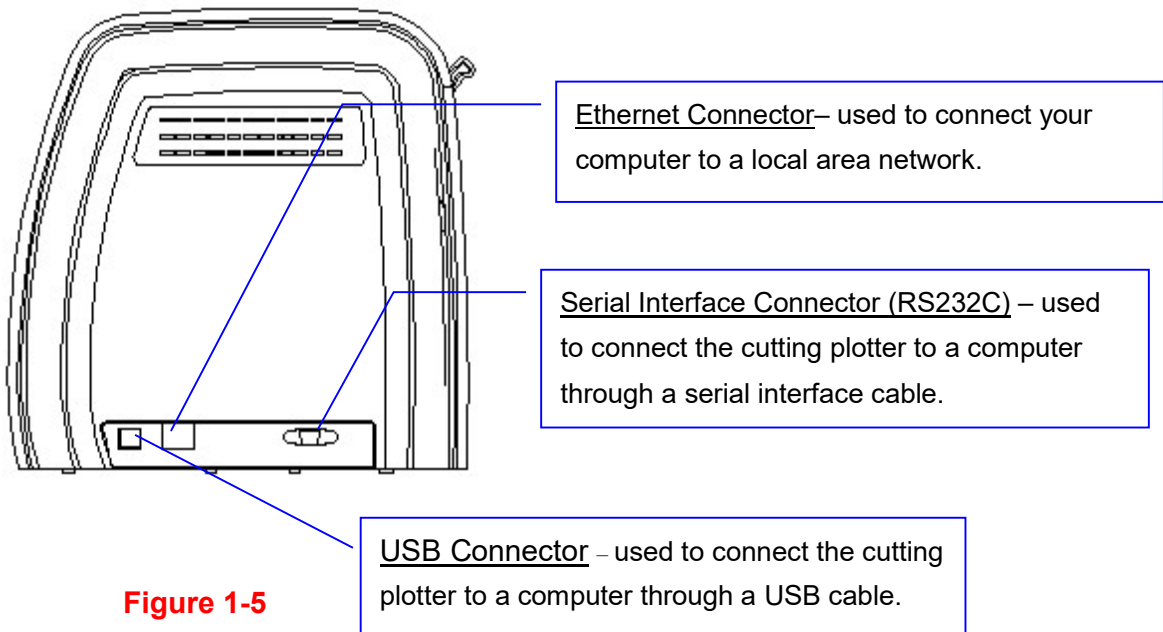

Figure 1-3

1.4.4 The Left-hand Side (Figure 1-4)



1.4.5 The Right-hand Side (Figure 1-5)



1.4.6 Pinch roller (Figure 1-6)

The Multi-Pressure Pinch Rollers give users three pressure settings to better cater to the different types of media that they are working with, for example, set light hold-down pressure of the pinch roller in the middle when cutting thin materials such as window tinting film.

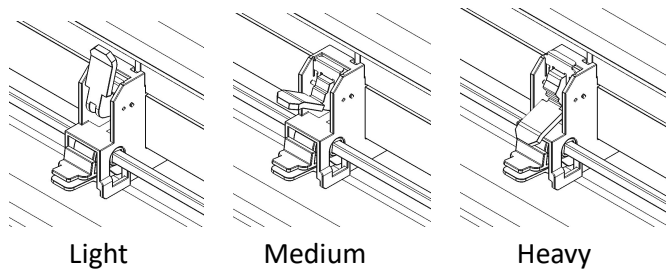
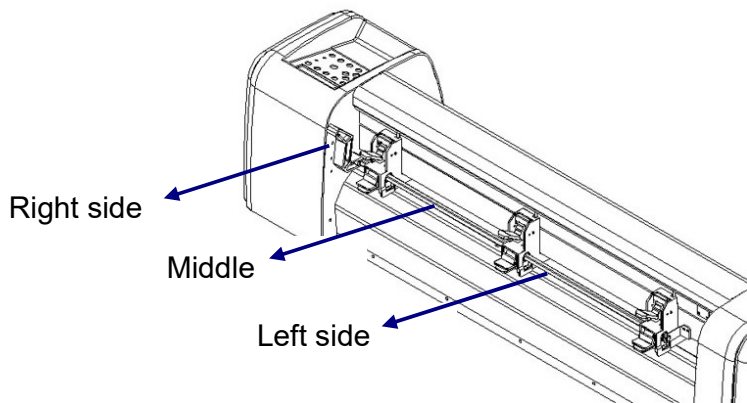

Figure 1-6

Please note that the pressure of the pinch rollers on the left and right sides should always be the same or heavier than the pinch rollers in the middle. The pressure of the pinch rollers on the left and right sides should be set to the same pressure setting. You can use the following combinations of the pinch rollers. (**Table 1-1**)



Left side	Middle	Right side
Heavy	Medium	Heavy
Medium	Medium	Medium
Medium	Light	Medium

Table 1-1

Chapter 2 Installation

2.1 Precaution

Please read below information carefully before you start installation.

Notice 1

- Make sure the power switch is off before installing the cutting plotter.
- Carefully handle the cutter to prevent any injuries.

Notice 2 Choosing a proper place before setting up the cutting plotter

Before installing your cutting plotter, select a suitable location, which meets the following conditions.

- The machine can be approached easily from any direction.
- Keep enough space for the machine, accessories and supplies.
- Keep the working area stable, avoiding sever vibration.
- Keep the temperature between 15 and 30°C (60-86oF) in the workshop.
- The relative humidity of the working environment should be between 25% and 75%.
- Protecting the machine from dust and strong air current.
- Preventing the machine from direct sunlight or extremely bright lighting.

Notice 3 Connecting the Power Supply

Check the plug of the power cord to see if it matches with the wall outlet. If not, please contact your dealer.

- Insert the plug (male) into a grounded power outlet.
- Insert the other end (female) of power cord into the AC connector of cutting plotter.

Notice 4 Tightening or Loosing Screws with Screwdriver

Whether manual or electric screwdriver, be careful not to use excess torque force when tightening or loosing screws. When tightening or loosing iron and stainless steel screws, please refer to the following screw torque standard table, other materials screws are not included.

Screw diameter	Torque value (kgf-cm)
	Torque standard for high hardness materials
M3	6
M4	16
M5	30
M6	50

2.2 Stand & Flexible Media Support System (for RX II-101S/132S/183S)

Step 1

Please examine supplied items in the accessory box of stand carton:

- 2 pieces of base beams
- 2 pieces of side beams
- 1 piece of stand beam
- 20 pieces of M6 screws
- 1 piece of M5 L-shape hexagon screw driver
- 1 piece of Installation Guide for Stand Set

Step 2

- Remove the plotter body and the accessories from the shipped carton.
- Assemble the base beam to the side beam with 2 screws to form a T-shape stand. (See Figure 2-1)



Figure 2-1

Please pay attention to the direction of the base beam (the wheel on the front end of the beam comes with a break while the rear one is on its own).

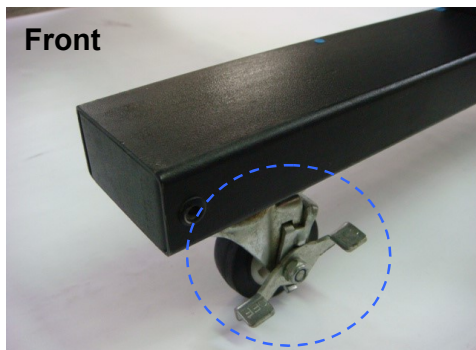

Figure 2-2

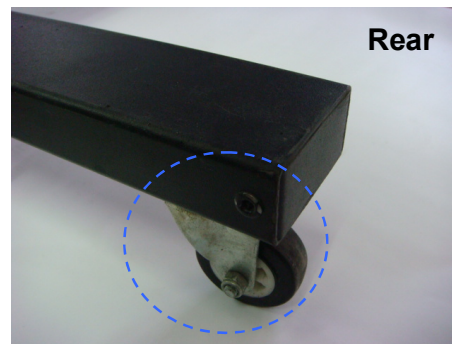
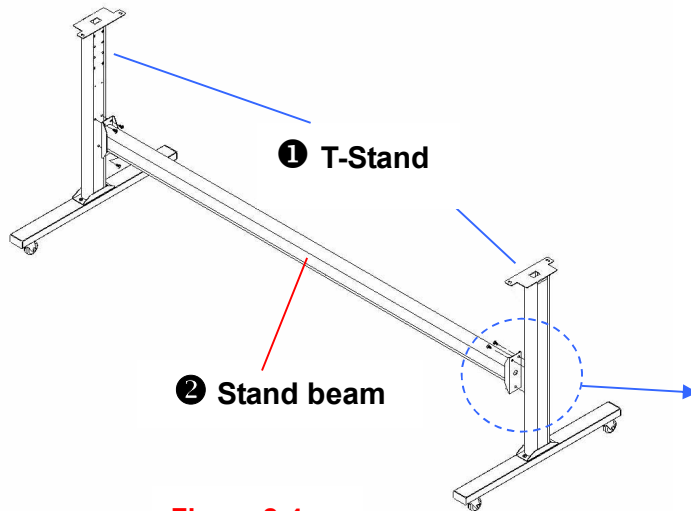

Figure 2-3

Step 3

Place the stand beam upright on the T-stand and follow number ① ② to assemble (See Figure 2-4 & 2-5). There is hexagon socket head screws fasten on the T-stand on both side taken as locating pins.

**Figure 2-4****Figure 2-5****Step 4**

Position the stand beam perpendicularly to part ① and put the screws into the holes and tighten them as Figure 2-5. Then the complete picture of stand will be like Figure 2-4.

Step 5

Remove the cutting plotter from the carton. Position your stand under the plotter, on the bottom of the plotter, there is one hole on each side in the position corresponding to the locating pins, so the locating pins can be located into the holes. Then insert the screws into the holes on the stand to fix the plotter and tighten them up as shown in Figure 2-6.

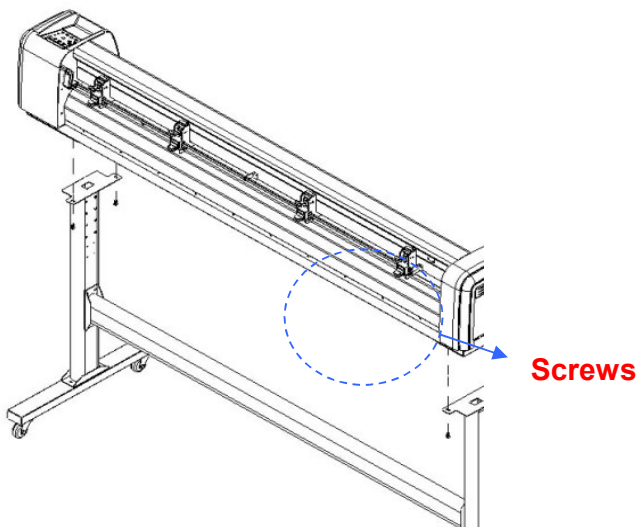

Step 6

Insert the roll holder support with the screws into the holes of the stand, and then tighten them up as shown in Figure 2-7. You could decide roll holder support's position by inserting into different holes.

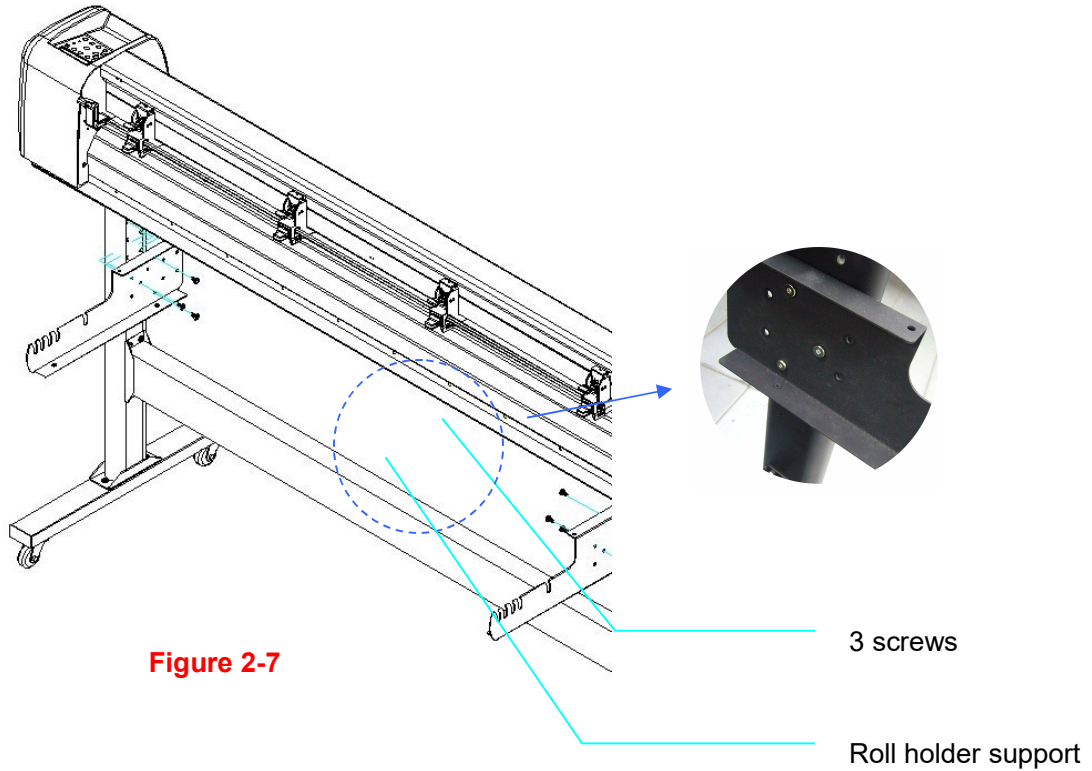

Figure 2-7

Step 7

Place two roll holders onto the roll holder support and ensure the white protrusion is wedged in the groove. (Figure 2-8)

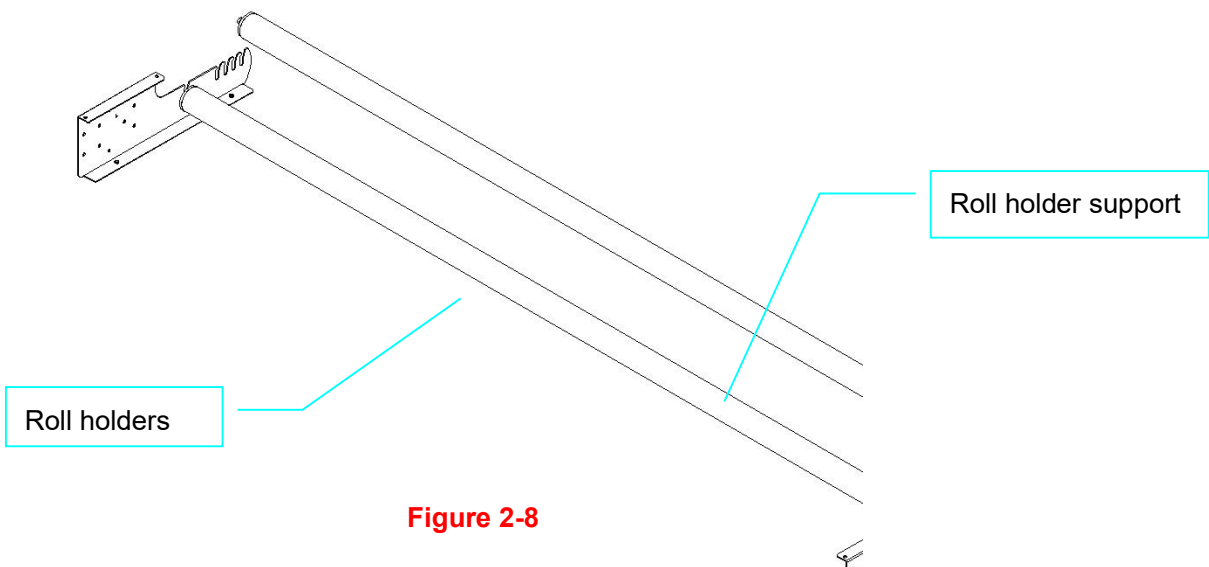

Figure 2-8

Step 8

Turn the screw counter-clockwisely for around three times after unpacking the roll holder (Figure 2-9).



Figure 2-9

Step 9

Insert the end of the roll holder without the damper into the left roll holder support and then insert the end of the roll holder with the damper into the right roll holder support and ensure the white protrusion is wedged in the groove (Figure 2-10).



Figure 2-10

Step 10

Tighten the screw on the damper until it is securely attached to the right roll holder support (Figure 2-11).



Figure 2-11

Step 11

Lastly, the complete picture will be shown like below. (Figure 2-12)

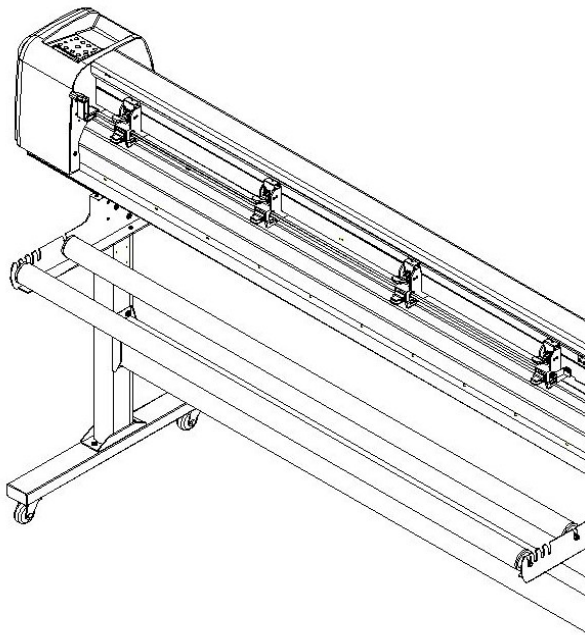
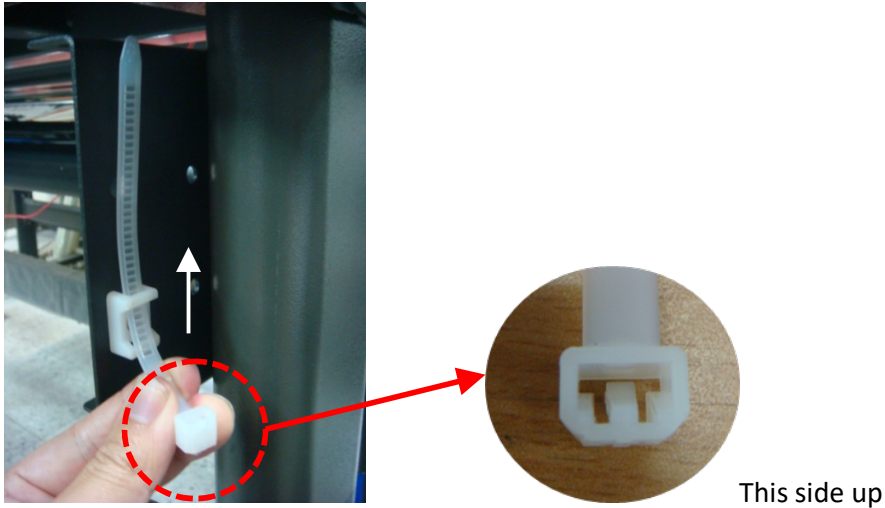

Figure 2-12

2.3 USB Cable Tie and Saddle

The USB cable tie and saddle assembly for the stands with Flexible Media Support System only.

Step 1 Insert the cable tie into the upper hole of cable saddle from bottom to top.



Step 2 Place the USB cable into the cable tie and tighten the cable tie.

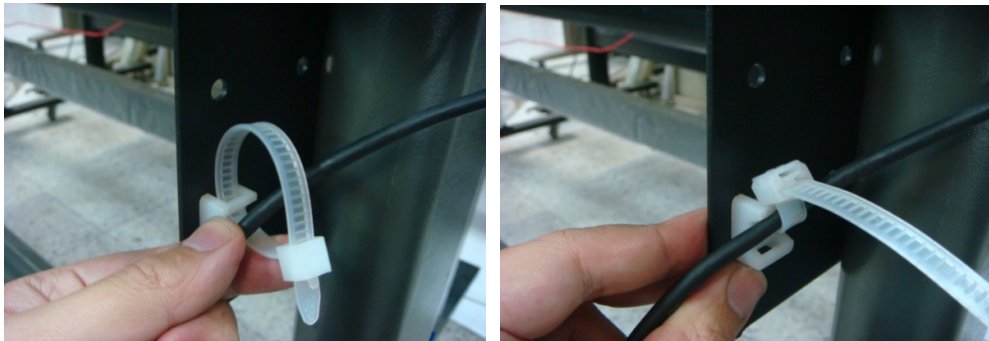

Step 3 Insert the cable tie end into the lower hole of cable saddle to finish the job.

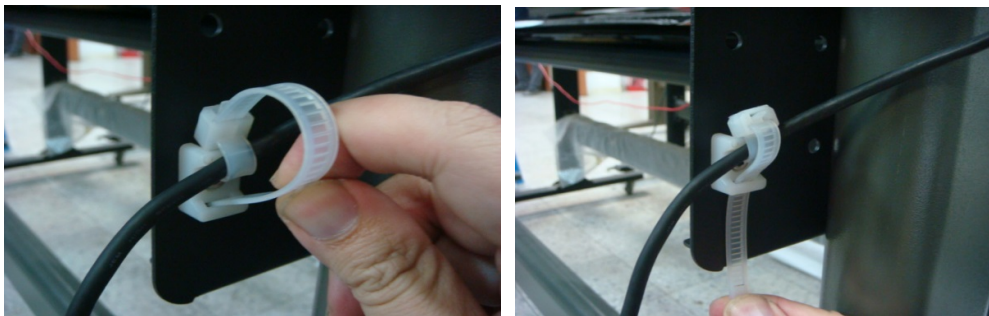

Untied way: pull out the cable tie → pull up the pin → release the cable tie.

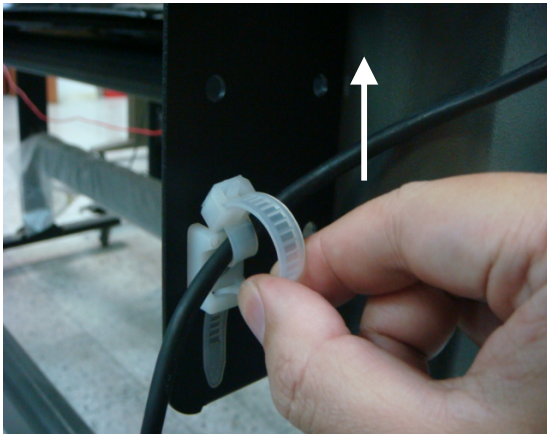

Pull out the cable tie

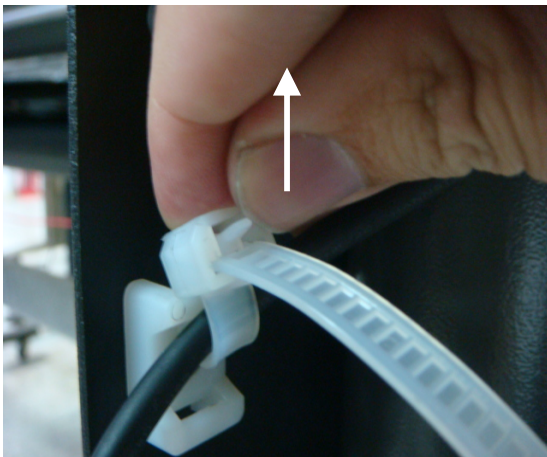

Pull up the pin

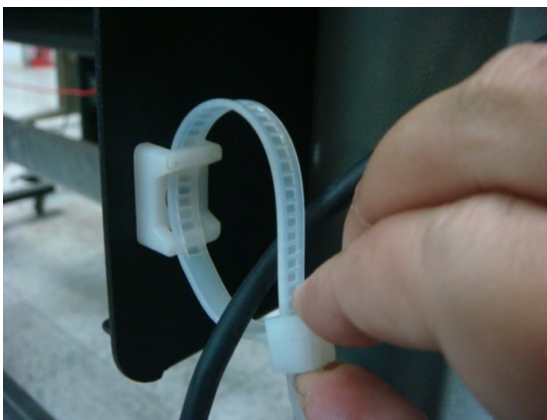

Release the cable tie

2.4 Desktop Flexible Media Support System (For RX II-61 only)

Step 1

Please examine the following items in stand carton's accessory box:

- 1 set of Roll Media Flange (2 pieces)
- 1 set of Roll Holder (2 pieces)
- 1 set of Roll Holder Guide Bushes (4 pieces)
- 1 set of Roll Holder Support (2 pieces)
- 1 set of Desktop Support Bracket (2 pieces)
- 4 pieces of Plastic Foot
- 4 pieces of M4 screws
- 12 pieces of M6 screws
- 1 piece of M4 L-shape hexagon screw driver
- 1 piece of M5 L-shape hexagon screw driver
- 1 piece of M6 L-shape hexagon screw driver (for adjusting the screws of Roll Holders)
- 1 piece of Installation Guide for Roll Holder

Step 2

Put the 4 Plastic Foot under the Roll Holder Support and insert the M4 screw into the hole of Plastic Foot and tighten them with the M4 L-shape screw driver. (Figure 2-13)

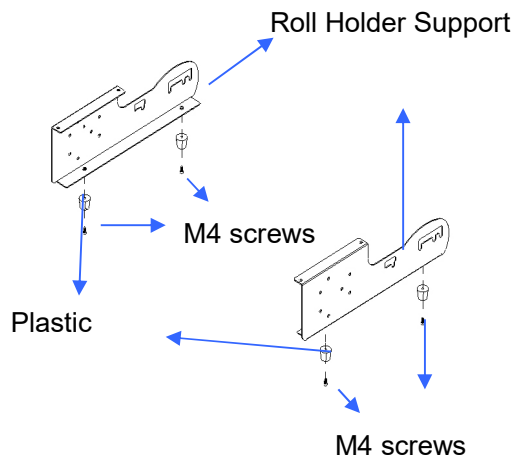

Figure 2-13

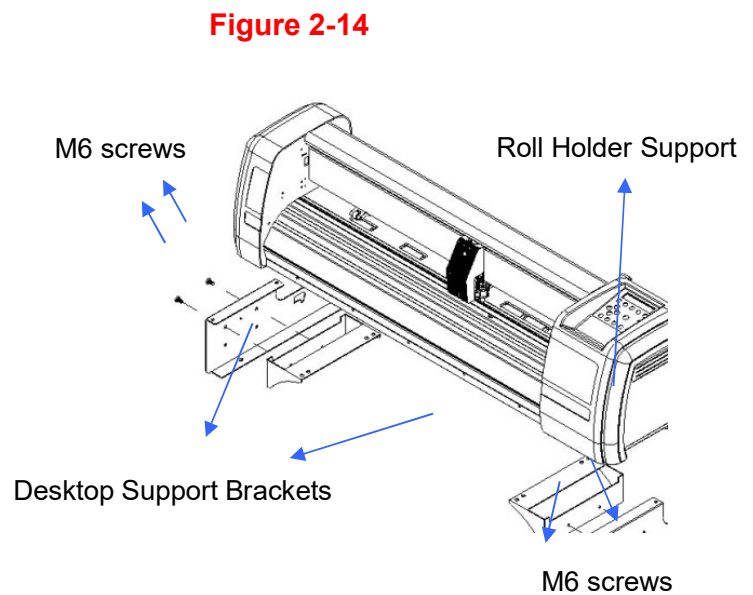

Figure 2-14

Step 3

Position the Desktop Support Brackets beside the Roll Holder Support and insert M6 screws into the Roll Holder Support and tighten them with M6 L-shape screw driver. (Refer to Figure 2-14).

Step 4

Put the bottom of machine in lateral, and position the Roll Holder Assembly beside the bottom of the machine. Then, insert the M6 screws into the holes of Roll Holder support assembly and tighten them with M6 L-shape screwdriver. Like Figure 2-15.

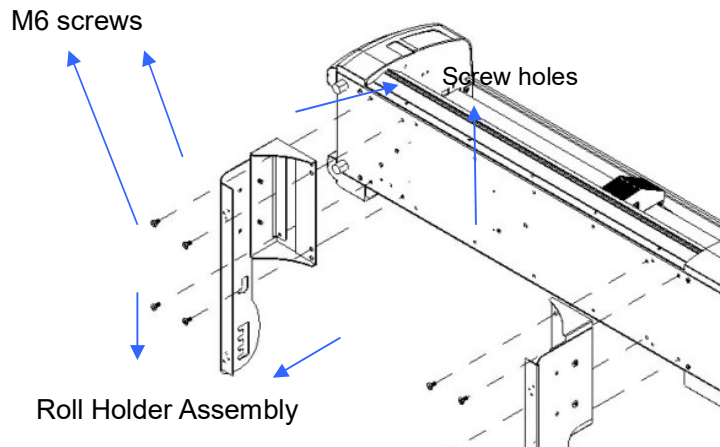
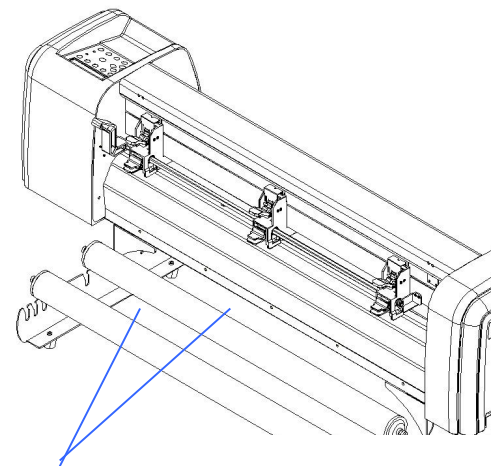
**Figure 2-15****Figure 2-16****Step 5**

Place the two roll holders into the holes of Roll Holder Support (Figure 2-16).

Step 6

The complete Desktop Media Support System will be shown as in Figure 2-17.

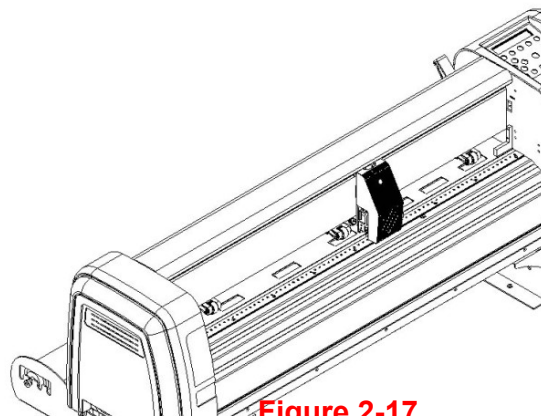

2.5 Instruction of Damper Roller

Turn the wheel as instructed below to adjust damping. The bigger the number is, the stronger the damping. The volume symbol sticker indicates the damping level (Figure 2-18,19).

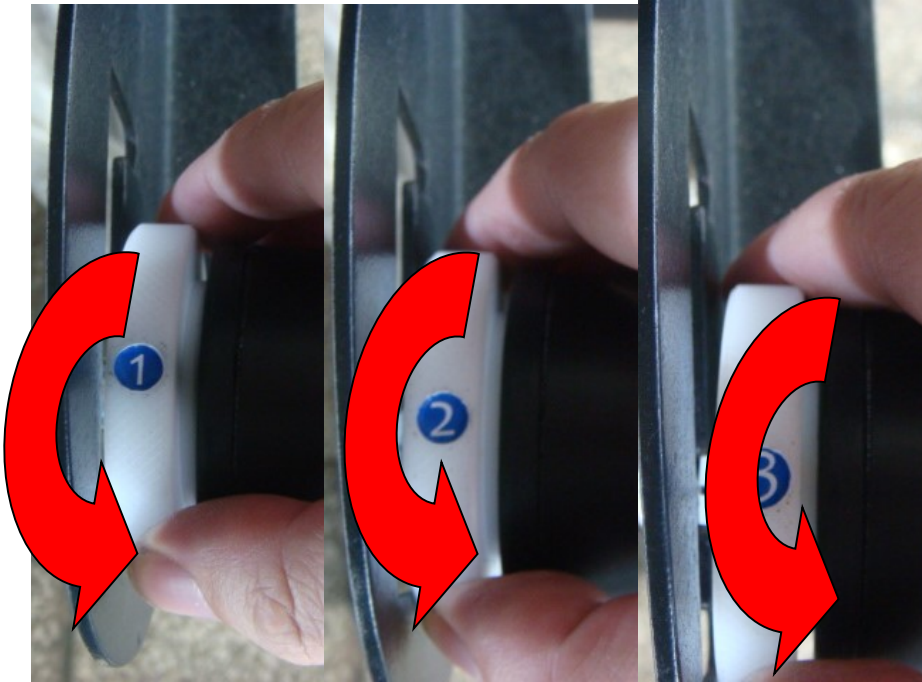

Figure 2-18



Figure 2-19

2.6 Blade and Blade Holder Installation

2.6.1 Blade Installation

Figure 2-20 is the illustrator of the blade holder. Insert a blade into the bottom of the blade holder and remove the blade by pushing the pin. Make sure that your fingers are away from the blade tip.

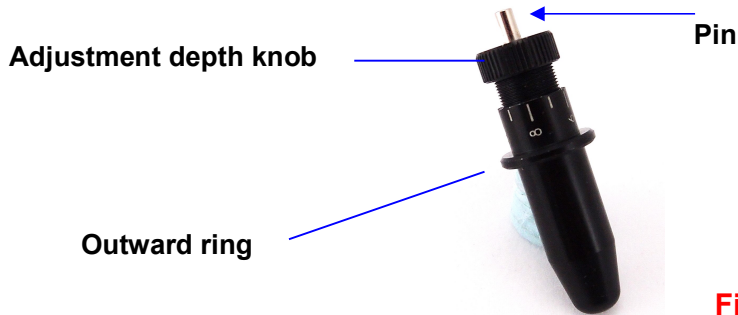

Figure 2-20

Step 1

Install blade (Figure 2-21).

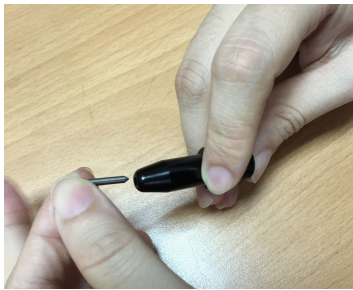

Figure 2-21

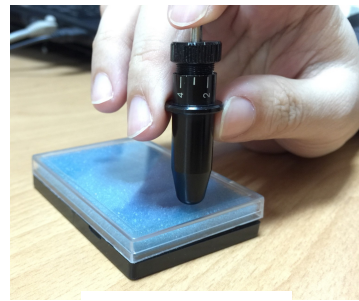

Figure 2-22

Step 2

Push the blade to the bottom of the blade holder. (Figure 2-22).

Step 3

Adjust the blade tip to suitable length by screwing "Blade tip adjustment screw" clockwise or count-clockwise. (Figure 2-23).



Figure 2-23

Tips:

"The proper length" means the blade's length is adjusted 0.1mm more than film's thickness. That is, if the thickness of film is 0.5mm, then blade's length is properly adjusted 0.6mm and it can completely cut through the film layer yet avoid penetrating the backing.

2.6.2 Blade Holder Installation

Step 1

Insert the blade holder into tool carriage. Please note the outward ring of the holder must put into the grooves of carriage firmly (see Figure 2-24), then fasten the case (Figure 2-25).



Figure 2-24



Figure 2-25

Step 2

Use the reversing steps to remove the blade holder.

Step 3

Eject the blade. Push “Blade eject pin” to eject blade when the blade needs to be replaced.

Caution!!

The blade will lose its sharpness after a period of usage; the cutting quality might be affected. By increasing the cutting force, it might do the trick. However, once the blade is worn out and no longer provides a reliable cutting, you should replace a new one. The blade is consumable and must be replaced as often as necessary to maintain the cutting quality. The quality of the blade deeply affects cutting quality. So be sure to use a high quality blade to ensure good cutting results.

2.6.3 Extension Holder Installation

Extension holder is used to move the blade holder to be positioned above the groove of the bottom to prevent the blade from dull easily when doing die-cutting. The extension holder needs to be installed to the carriage, then insert the blade holder into the extension holder. Please follow the step by step instruction below.

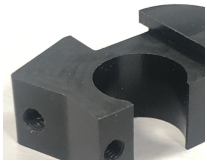

Extension holder

Step 1 Remove the case from the carriage.



Step 2 Insert the screw into the hole on the extension holder, and then fasten the case to the carriage. Please note the flange of the holder extension must put into the grooves of carriage.

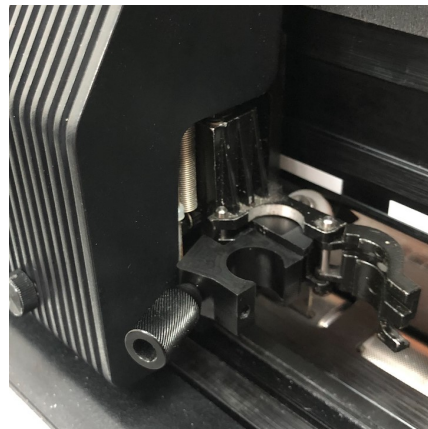
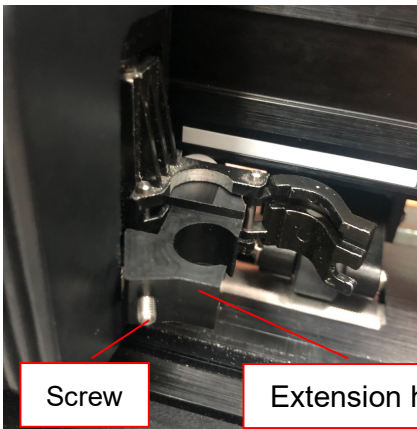

Step 3 Insert the blade holder into extension holder.



Step 4 Fasten the thumb screw to fix the tool carriage.



Step 5 The machine is ready to use.

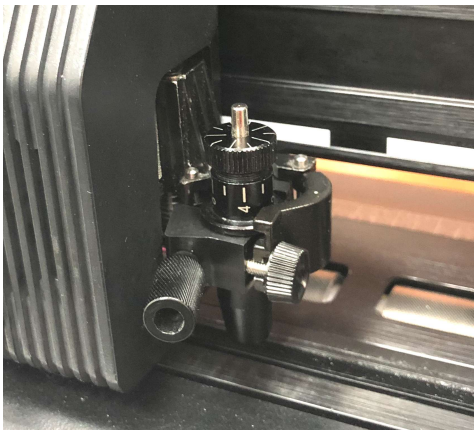

Step 6 Use the reversing steps to remove the blade holder.

2.7 Automatic Blade Length Detection

Figure 2.-26 is the new blade holder with a scale and the carriage with a mark. This blade holder detects blade length automatically and shows how the knob needs to be turned on the LCM.

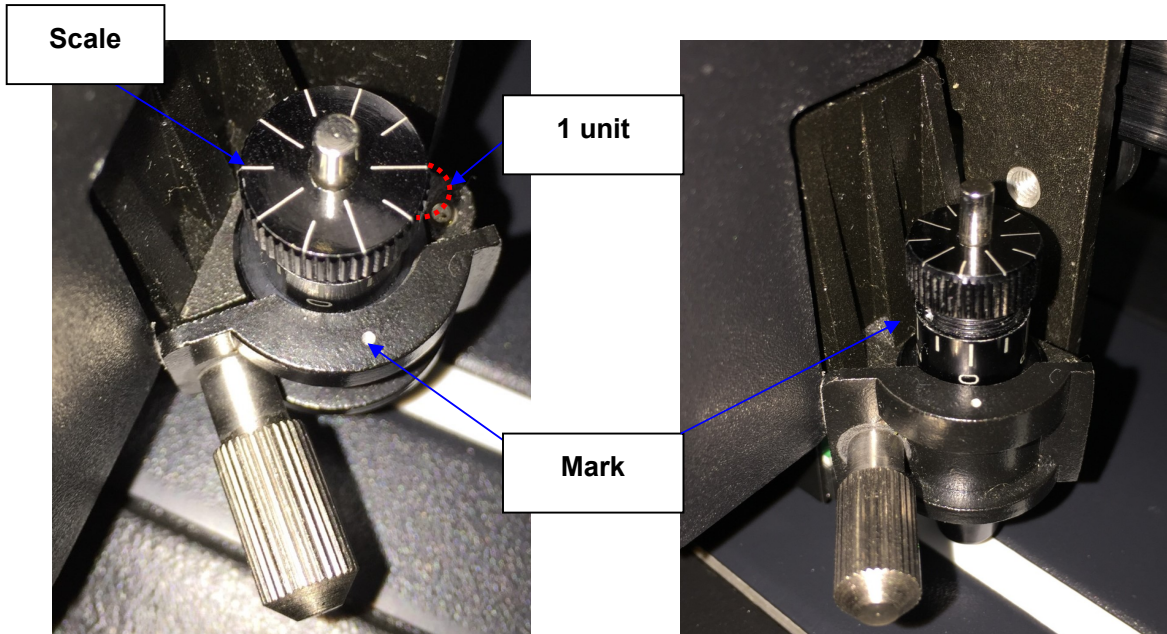

Figure 2-26

Figure 2-27

There are 10 units on the scale; each unit equals to 0.05 mm, allowing you to adjust the blade length for 0.00mm-5.00mm (Figure 2-27).

Follow the steps below to adjust the length of the blade:

1. Keep the blade tip within the blade holder before you start adjusting.
2. Align one of the scales on the blade holder to the mark on the carriage
3. Select “Blade Length Adjust” under “CUT TEST” on the LCM, enter the blade length wished in “Set Length”; test the blade holder first and then test the blade length by pressing ENTER.

Note: Keep the blade holder at the same position when you perform blade holder and blade length tests.

4. When blade holder and blade length tests are finished, the screen will show you to what degree (the unit of the value following “CW” or “CCW” is “circle”) and in which direction [CW (clockwise) or CCW (counterclockwise)] you should turn the adjustment knob.
EG, Turn CW 5 is telling you that you should turn the knob for 5 units clock-wisely (Figure 2-28, Figure 2-29).

5. The screen will show "Adjustment completes" when the value on the screen is 0, the blade length is perfect and no more adjustment needs to be made. Press "Enter" now to complete the process and you may start cutting at this point.

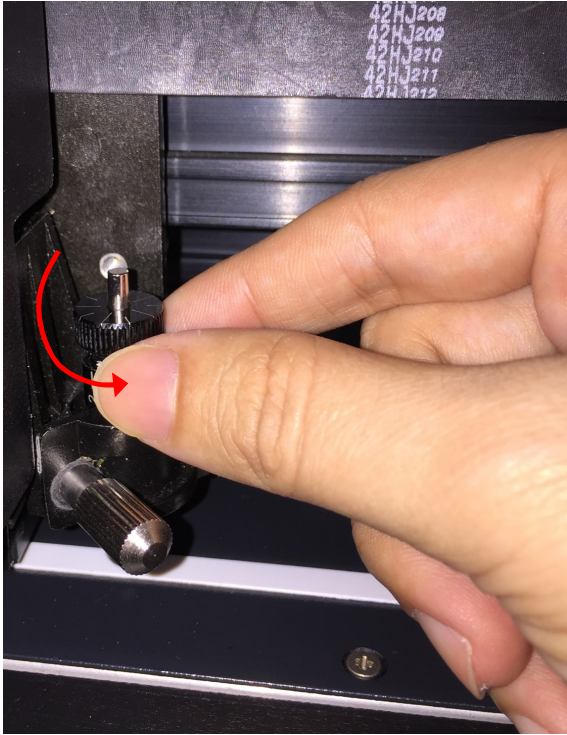

Figure 2-28

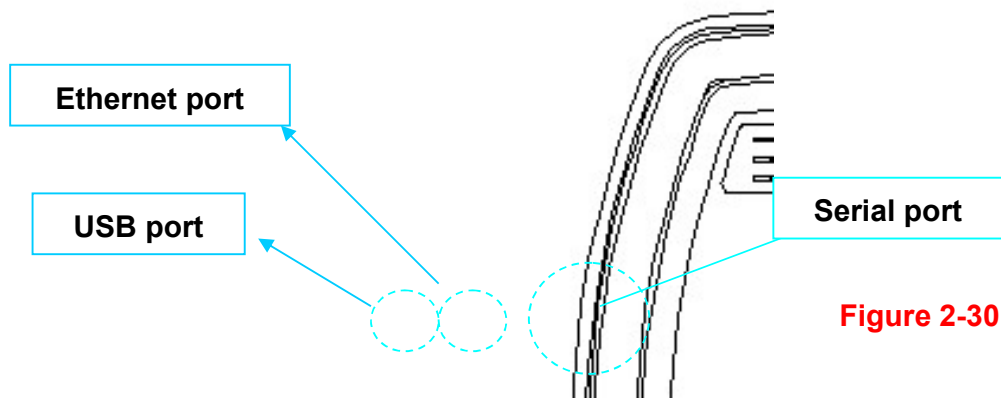

Figure 2-29

2.8 Cable Connection

The cutting plotter communicates with a computer through a **USB (Universal Serial Bus)**, **Serial port (RS-232C)** or an **Ethernet port**. This chapter shows you how to connect the cutting plotter to a host computer and how to set up the computer/cutting plotter interconnection.

!! Notice: When USB connection is enabled, the serial port will be disabled automatically.



2.8.1 USB Interface

RX II series build-in USB interface are based on the Universal Serial Bus Specifications Revision 2.0 (Full Speed).

2.8.1.1 Connecting your GCC cutter

1. Turn on the machine.
2. Connect the USB connector to the machine and then USB driver will installed automatically. It will take a few minutes to find the device. Please DO NOT disconnect the USB cable until the installation has completed.
3. You can double click the USB icon on the taskbar to make sure the USB device is detected.

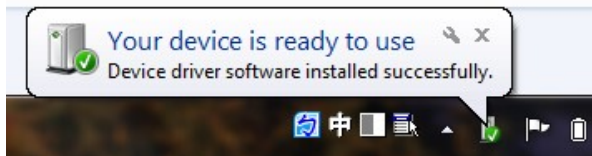

2.8.1.2 Installing the driver

Use the USB One-click Installation for quick driver installation. Follow the simple steps below for driver setup.

Caution!!

- ✓ If you are using Windows 7 and above as your operating system, make sure you log in using the “Administrator” account.

Step 1 Visit GCC website and go to “SUPPORT” page to download the user manual, driver and software (<https://www.gccworldnew.com/download.php>). **Please make sure that the USB device is connected before you start the driver installation.**



Step 2 You may use search function or directly click the product category to choose the model you want.

Download Area

Download Area

enter keywords to search

SEARCH

Or browse by machine model



Vinyl Cutter



Laser Engraver

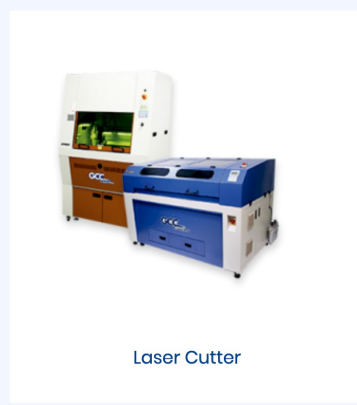

Laser Cutter



Download Area

Vinyl Cutter

Vinyl Cutter



Expert II A



i-Craft™ 2.0



AR-24



Expert II



Puma IV



Jaguar V / Jaguar V (PPF)



RX II / RX II (Creasing)

Download the driver according to the type of connection.

Product Brochure

Driver

Title	Size	Download
Cutter COM Driver_V2.21-03	11.2MB	Download
Cutter ETH Driver_V2.21-03	11.2MB	Download
Cutter USB Driver_V2.21-03	11.2MB	Download

User Manual

Step 3 Unzip the file and double click the driver.exe to start installing the Driver and AAS plug-in.

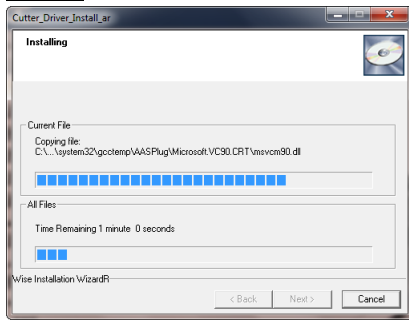

Step 4 If you were Windows 7 and above users, please click on the **red words** to instruct you how to disable Windows Update to allow success driver installation. And then click OK to next step.



Step 5 Please make sure the cutting plotter is powered on and connected to the USB device, and then click OK to next step.

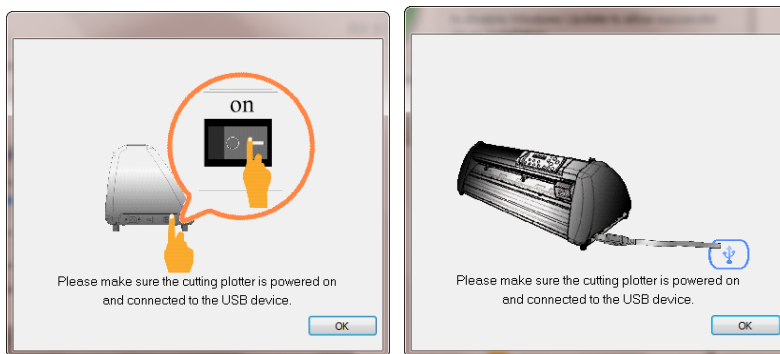

Step 6 Confirm to close all running application programs before you start installing the driver, and then click OK.

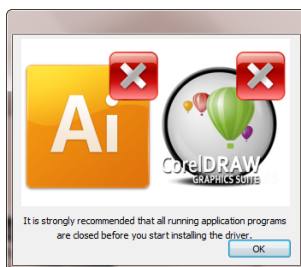

Step 7 The installation will take a few minutes to complete and you will see a message below and

click on “OK” upon completion. Enjoy your GCC cutter!

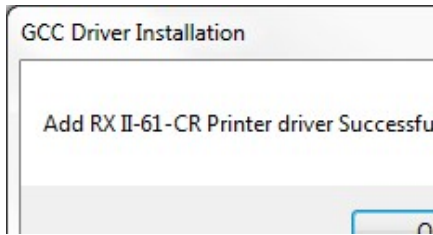

Step 8 If you want to install AASII VBA on CorelDRAW and Adobe Illusatrator, exit CorelDRAW and Adobe Illusatrator program, and then click on “Install.”

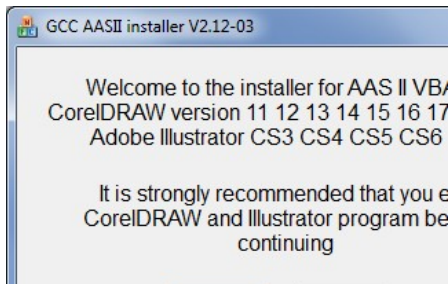

Step 9 Check Install Message to confirm CorelDRAW and AI version and then click OK.

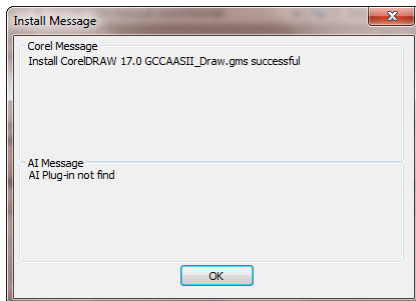

Note:

(1) If the driver is being installed for a second time, the user will be prompted as to whether a second copy of the driver installation is required.

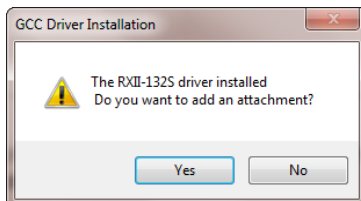

(2) If the user selects yes, a second copy of the driver will be installed.

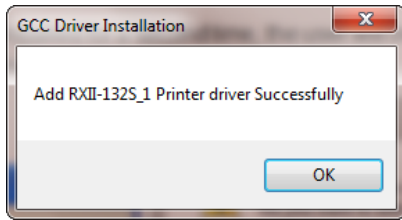

(3) For users who have upgraded Adobe Illustrator or CorelDRAW, please go to the **AAS Installer** page in the **Printer Properties** window and click "**Install**" to access the latest version of GCC AAS Plug-in.

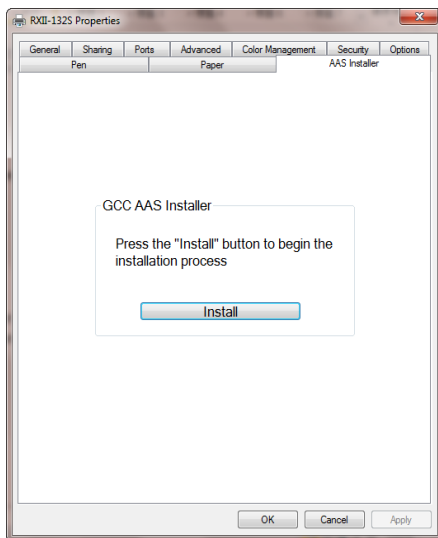

2.8.1.3 Driver Un-installation

You have to remove previous version driver installed on your PC system completely before you can install the latest version successfully. Please refer to below steps.

Step 1 Go to Control Panel\Hardware and Sound\Devices and Printers window. Right click the printer and select "**Remove device.**"

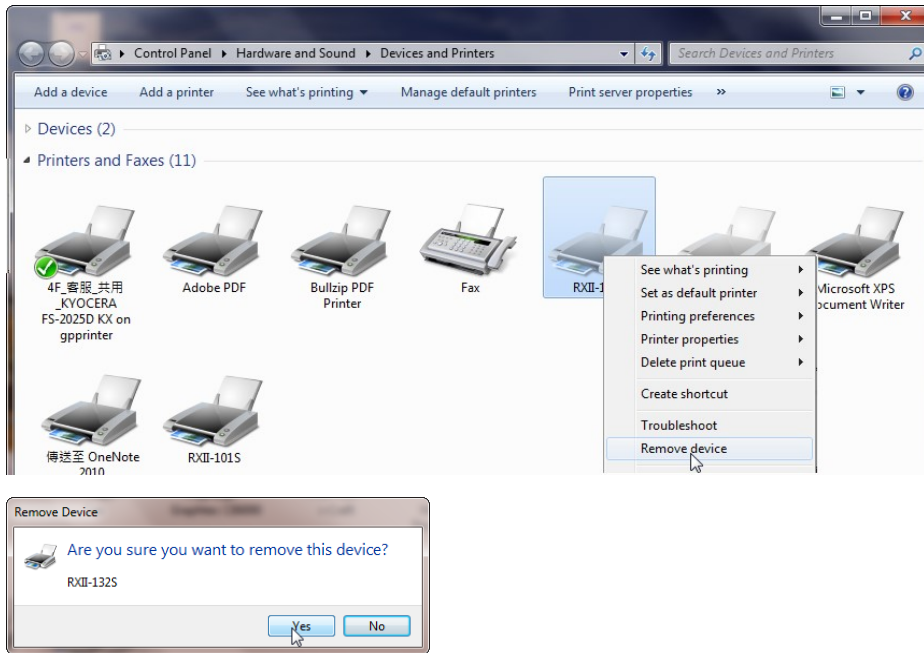

Step 2 After removing the unit, click on any printer on the page and select “**Print server properties.**” (For Win 7 and above)

Or right click on blank space and then select “**Print server properties.**” (For Windows XP)

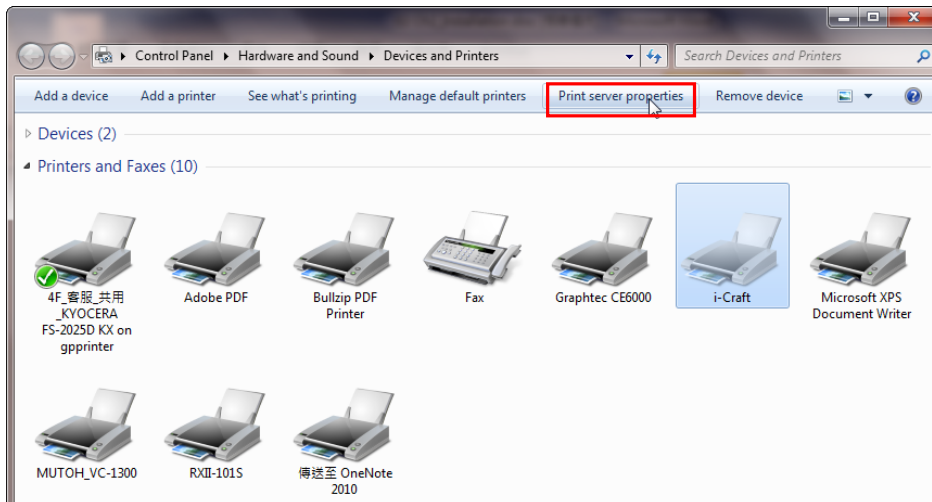

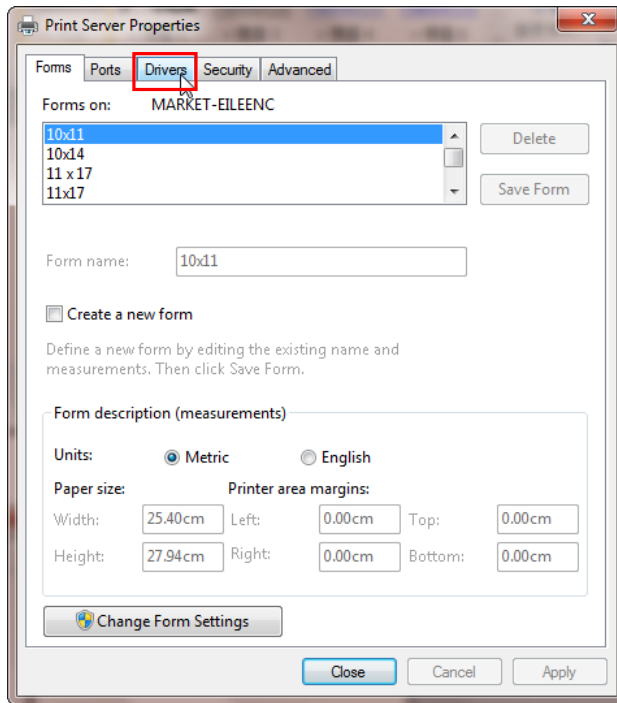
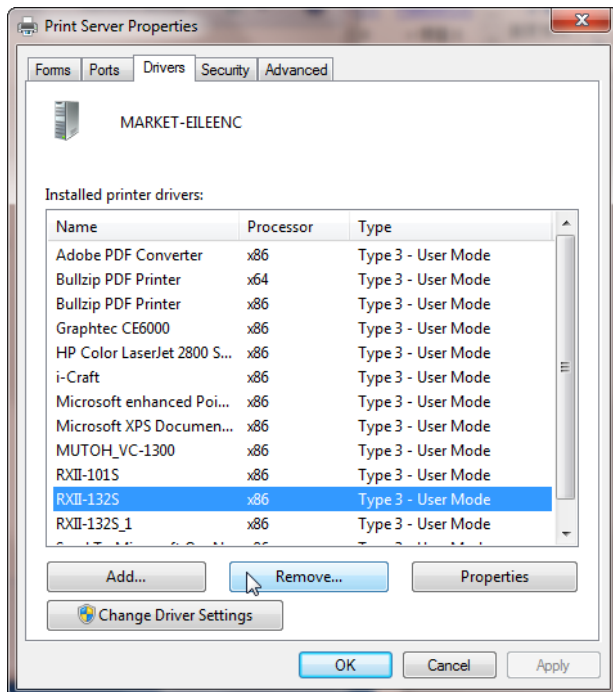
Step 3 Select “Driver” page**Step 4** Select the model and click on “Remove”.

Step 5 Select “Remove driver and driver package” and click OK.

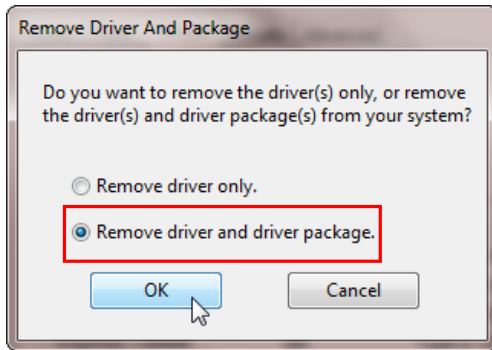

Step 6 Click Yes and then click “Delete” and “OK,” and the driver installed on PC is completely removed.

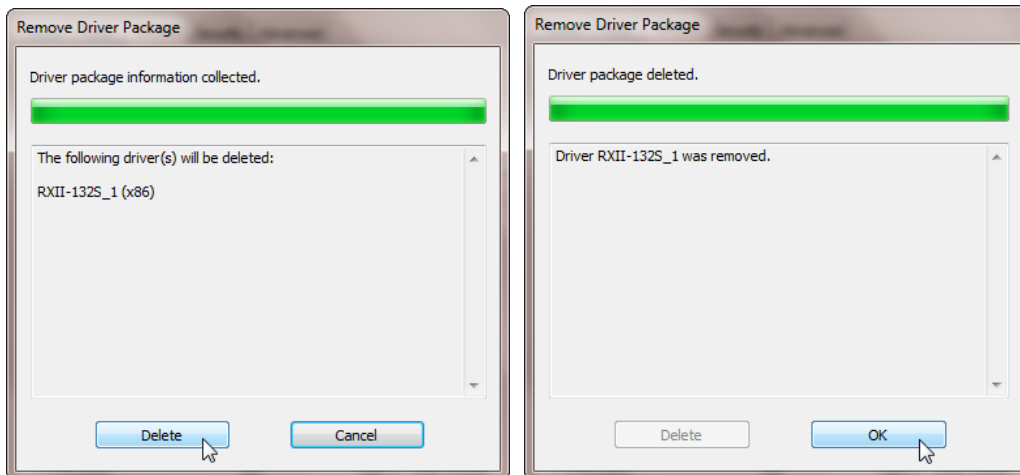
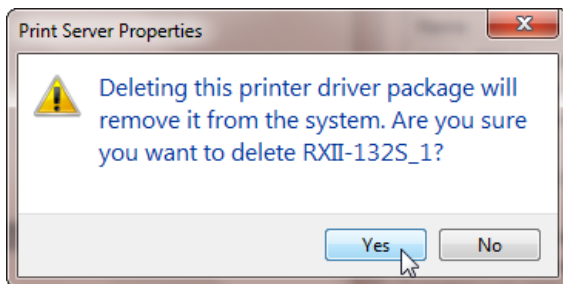

2.8.2 RS-232 Interface

- Connecting to the RS-232 (Serial) Port
 1. For IBM PC, PS/2 users or compatibles, connect the RS-232C cable to the serial connector of the assigned serial port (COM1 or COM2) of your host computer.
 2. Set up the communication parameters (Baud Rate and Data Bits/Parity) to match the setting of software package, refer to chapter 3 – “MISC” key description.

Caution!! Please turn off the plotter before plugging the RS-232C cable.

2.8.3 Ethernet Connection

1. Networking Connectivity Setup

Step 1 Connect the LAN port and Ethernet port on GCC cutting plotter with RJ45 Ethernet cable, and turn on the machine.



Step 2 Press **On/Off line** and then MISC button on your control panel.

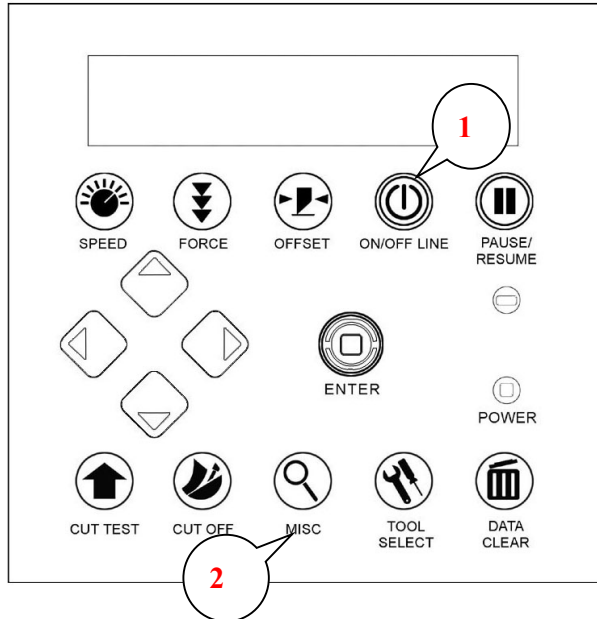

Step 3 Go to the **DHCP** page and select **Enable** through the up and down arrow keys, then press Enter.

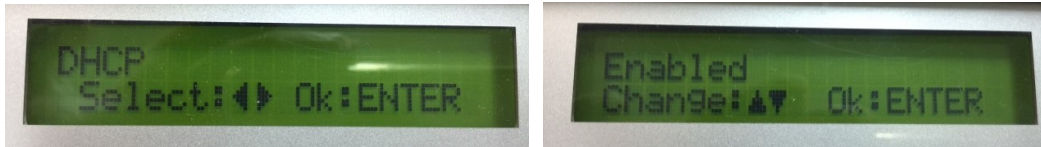

Step 4 The IP Address will be shown on the screen automatically. Please make notes of it.

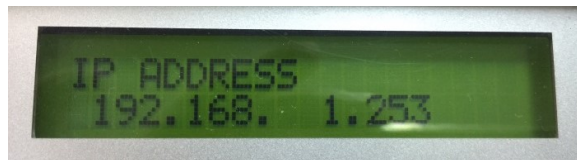

II. Ethernet Connectivity Setup

There are two ways to output your plot through Ethernet. If you output your plot through GreatCut, please follow the instruction **I. Output through GreatCut**; if you output your plot through Adobe Illustrator or CorelDRAW, please follow the instruction **II. Output through the Ethernet Driver**.

I. Output through GreatCut

GreatCut is a plug-in for CorelDRAW and Illustrator. (GreatCut installation please refer to chapter 2.9.1)

Instruction of Ethernet settings for GreatCut

Step 1 Open GreatCut and create a new file and cutting line.

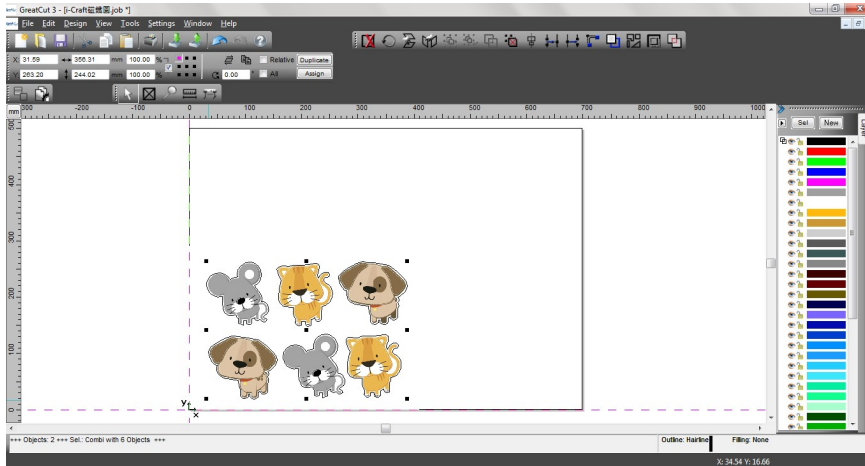

Step 2 Go to **Output Devices** under Settings.

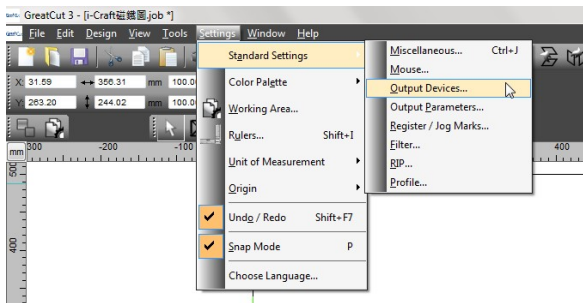

Step 3 Select a model at Driver in Setup Device window

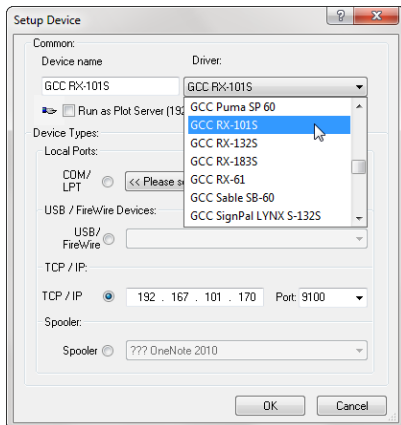

Step 4 Input the IP address you had acquired from the control panel to the TCP/IP. Click OK to complete settings.

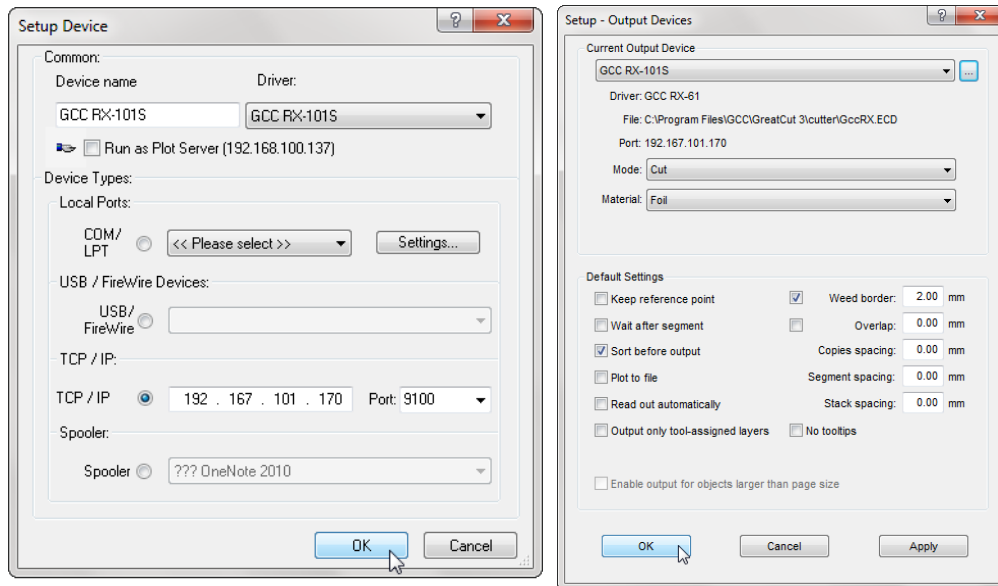

Step 5 Go to **Output** under File to check the settings.

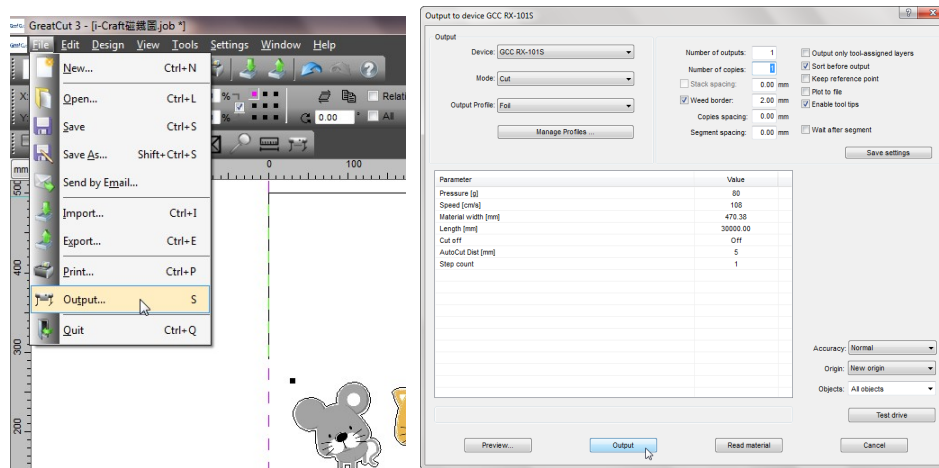

Complete the driver installation process and your GCC Cutting Plotter is now allowed to network.

Note: If you want to add new local device, please go to **Output Devices** under Settings, and press the button on the right of Current Output Device and select **Add local device** (if the device has been installed but you wanted to output through another device, please select **Change** to set the IP address of another device).

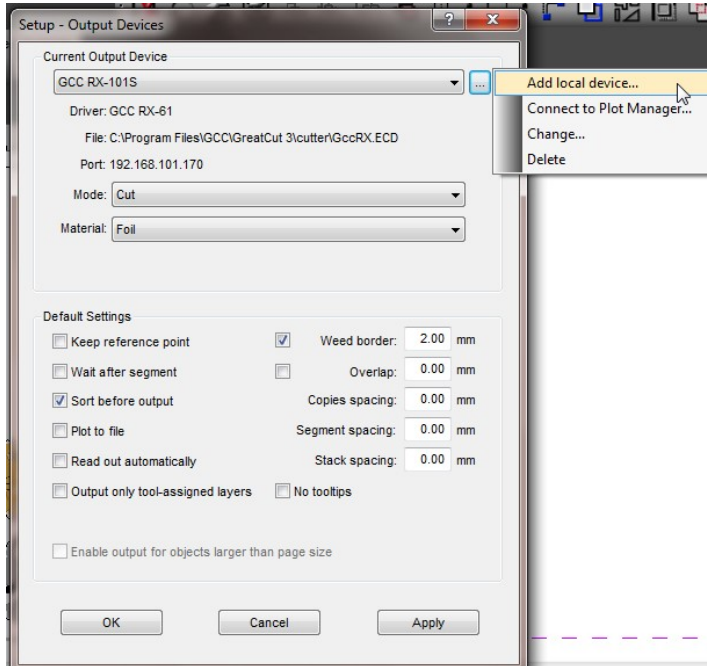

II. Output through Ethernet Driver

Step 1 Connect Ethernet cable to PC and install **Cutter Ethernet driver**. Then click OK to continue.

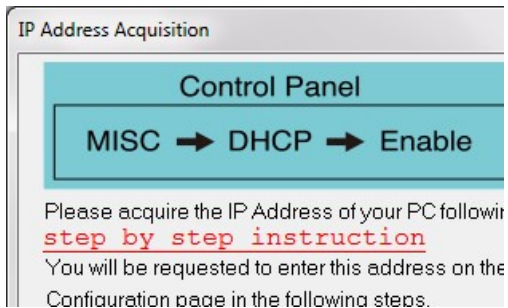

Step 2 Enter the IP Address shown on the control panel and select the model. (Please refer part 1 instruction.)

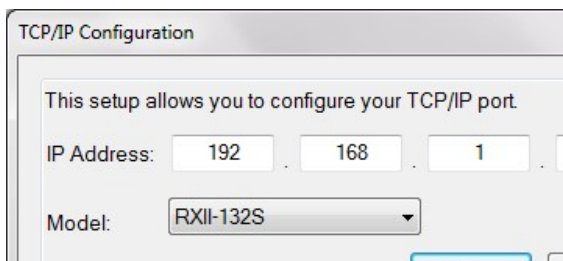

Step 3 The driver is installed. You can output from AI or CorelDRAW directly now.

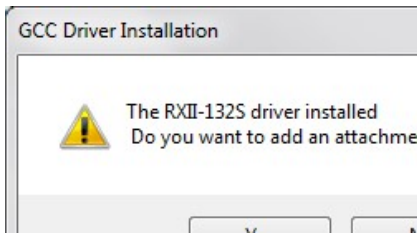

2.8.4 Data Transmitting

There are two options to transmit the data from the computer to the cutting plotter:

Option 1: With proper interface settings, the data can be transmitted from your application software package to the cutting plotters directly.

Option 2: Most cutting software packages are able to emulate **HP-GL** or **HP-GL/2** commands. As long as the file is **HP-GL** or **HP-GL/2** format, the cutting plotter can output the data precisely.

2.8.5 Printer Sever Shared Setting

In “A-PC”, set the printer driver as a shared printer, then use B-PC to connect A-PC’s printer driver via internet.

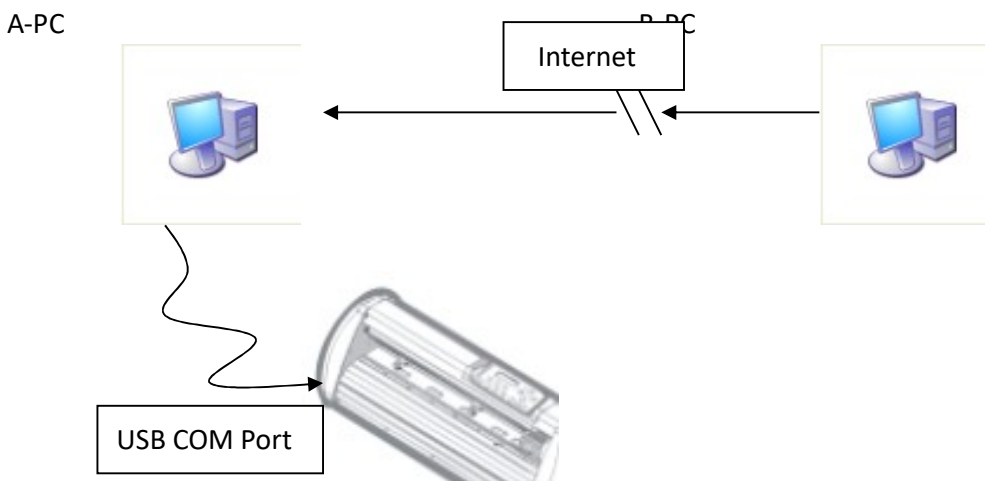

Step 1

Please set A-PC’s printer driver to shared printer. (Right-click on printer icon, choose “Printer properties”. Click “Sharing” tab then check “Share this printer”)

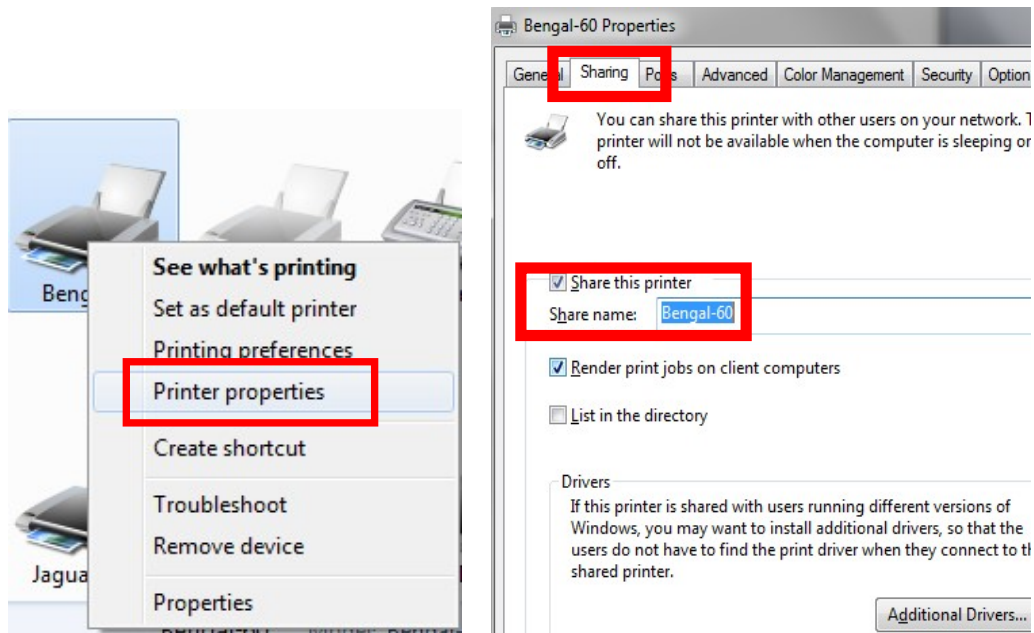
**Step 2**

Click "Advanced" tab, then choose "Print directly to the printer" option.

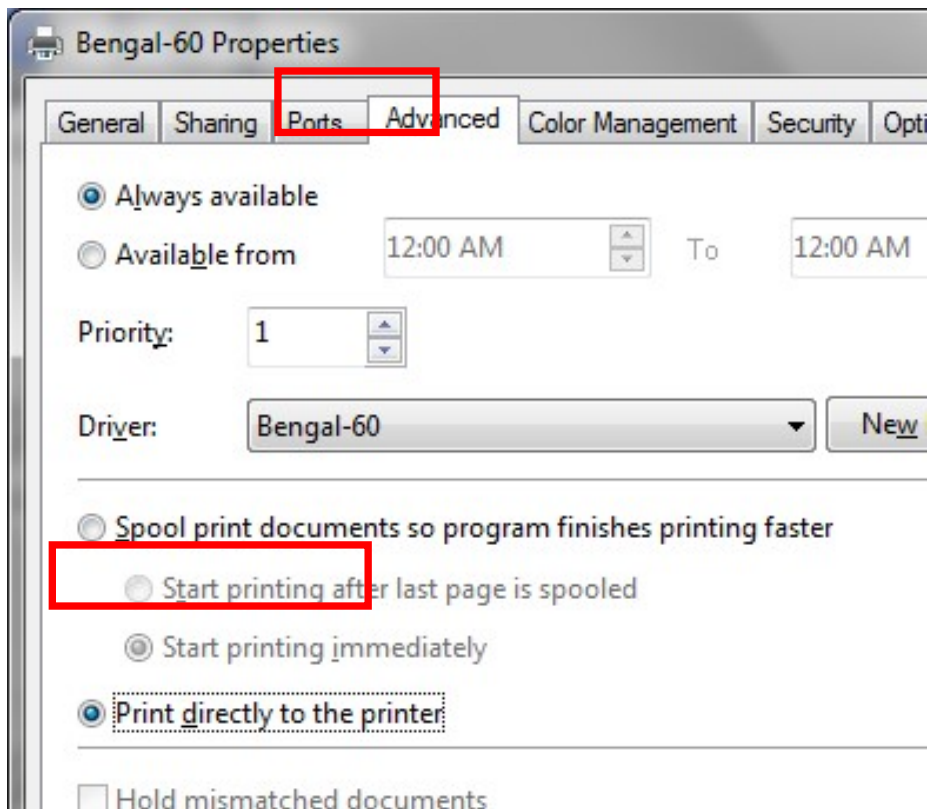

Step 3

Send a job to the machine to check if A-PC is connected to the machine.

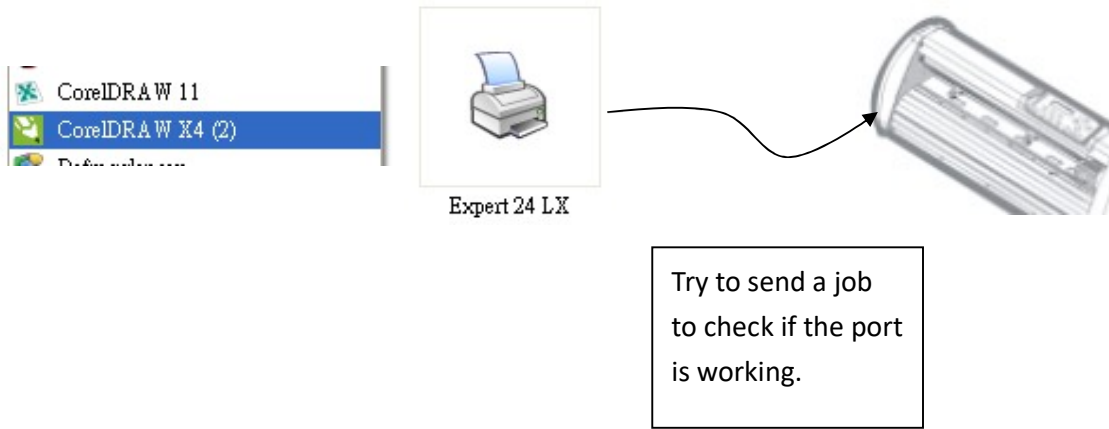

Step 4

Activate A-PC's Printer Driver from B-PC's Network.

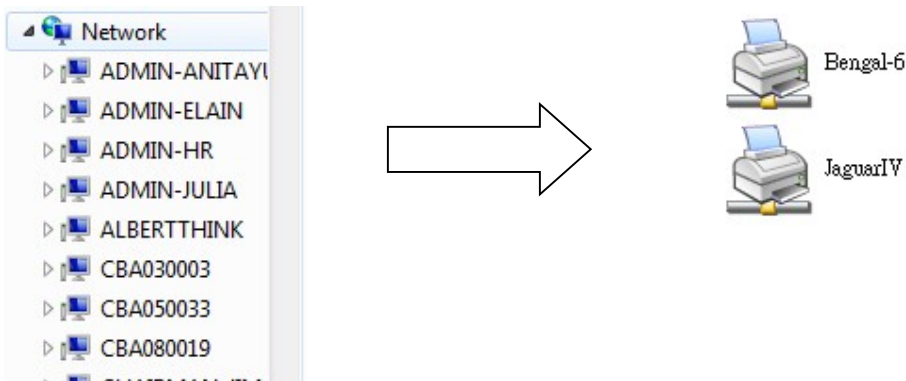

Step 5

Right-click on the printer icon, and select "Connect" to connect A-PC's printer.

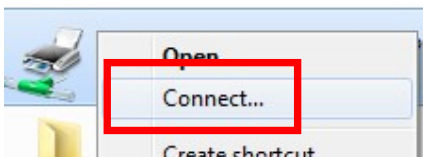

2.9 Software Installation

2.9.1 GreatCut-S Installation

2.9.1.1 Auto Installation

1. Visit <http://gccf.gcc.com.tw/gccclub/login.aspx> and log in your GCC Club account.



or create a new GCC club account if you do not have one. Click “I Agree”, fill in the required information and click “Submit” to sign up.

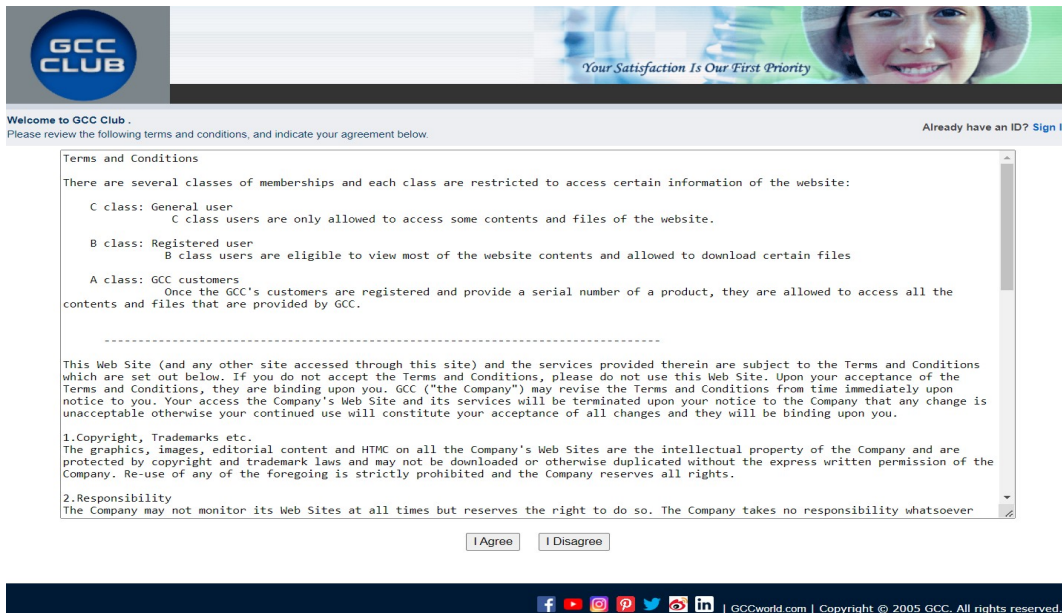

Sign up for GCC Club Already have an ID? [Sign In](#)

Create Your ID ✖ Please do not use special characters or spaces in your GCC ID or Password.

Your GCC ID (Must be 5-20 characters)
 Password
 Re-enter password

Personal Information

Name
 Email (Enter a valid email for immediate confirmation.)
 Country
 Cell Phone

Subscribe to our free e-newsletters below

Yes, I wish to receive e-newsletters and offers from GCC.
 I understand that I may change my preference or unsubscribe from any publication, marketing, invitation at any time by clicking on the Unsubscribe contained in the emails I receive.

Please calculate it if you are not a robot: $0 + 3 =$

You should receive an eMails with activation link and click the link to activate your account.

Thank you for registering with the GCC Club. Please find your registration information below.

*Please be sure to click

http://gccf.gcc.com.tw/gccclub/mail_confirm.aspx?enable=Y&ID=GCCMKT1&Name=GCCMKT&lang=
to activate your account.

Personal Information	
Name	GCCMKT
Email	keira.lee@gcc.com.tw
Cell Phone	+886972066897
Country	Taiwan

Please note that most of the contents on the GCC Club are exclusive to GCC product owners. If you own a GCC machine and its serial number starts "H" to "L", we encourage you to register your product to receive an additional 3-month limited warranty extension. Other Benefits include: product applications, tips and parameters, technical support and trouble shooting tips, driver and software updates, user manual document.

2. Go to GCC Club, click "GreatCut-S voucher code" on the left side.

The screenshot shows the GCC Club website interface. On the left, a navigation menu lists various services, with 'GreatCut-S Voucher Code' highlighted in a red box. The main content area features a welcome message for user 'GCCMKT' and a list of benefits: access to product videos, a 3-month warranty extension, latest drivers, and technical support. Below this, there are three product categories: LaserPro Engraver, LaserPro Marking System, and Cutting Plotter, each with a representative image.

3. Enter your voucher code and click "submit".

The screenshot shows the 'GreatCut-S Serial Number' page on the GCC Club website. The page contains a form for entering a voucher code. The 'Voucher Code' field is filled with '2KUK4LCZQG71EBKVP8'. Below the form, there is a CAPTCHA question: 'Please calculate it if you are not a robot: 2 + 1 = 3'. A 'Submit' button is located at the bottom of the form.

- You will get your GreatCut-S serial number.

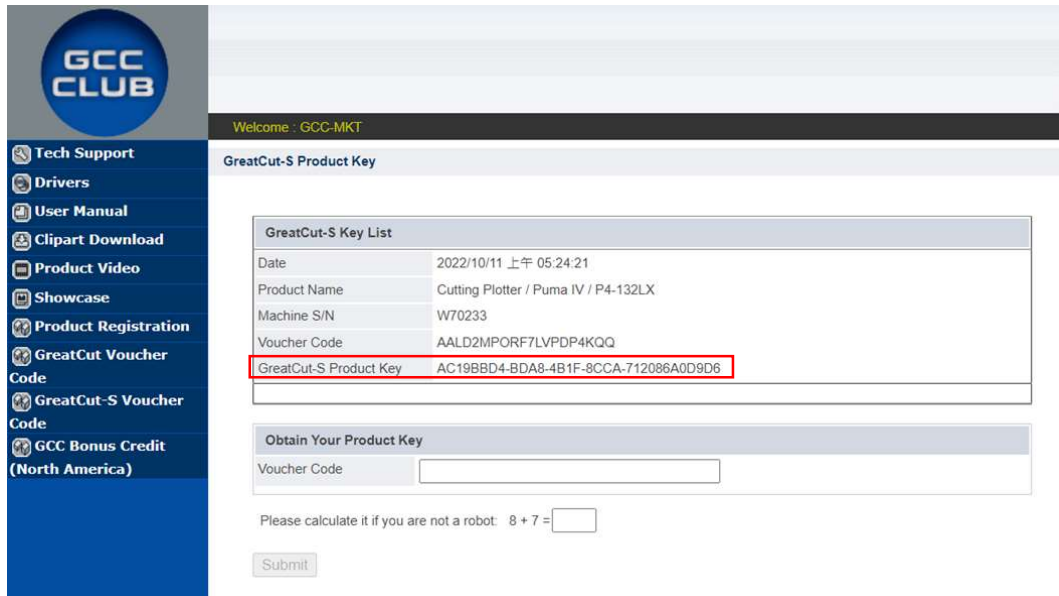

The screenshot shows the GCC CLUB website interface. On the left is a navigation menu with links for Tech Support, Drivers, User Manual, Clipart Download, Product Video, Showcase, Product Registration, GreatCut Voucher Code, GreatCut-S Voucher Code, and GCC Bonus Credit (North America). The main content area is titled "GreatCut-S Product Key" and contains a "GreatCut-S Key List" table. The table lists registration details, with the "GreatCut-S Product Key" highlighted in red. Below the table is a form to "Obtain Your Product Key" with a "Voucher Code" input field and a CAPTCHA challenge: "Please calculate it if you are not a robot: 8 + 7 = [input field]". A "Submit" button is located at the bottom of the form.

GreatCut-S Key List	
Date	2022/10/11 上午 05:24:21
Product Name	Cutting Plotter / Puma IV / P4-132LX
Machine S/N	W70233
Voucher Code	AALD2MPORF7LVPDP4KQQ
GreatCut-S Product Key	AC19BBB4-BDA8-4B1F-8CCA-712086A0D9D6

- Visit <https://www.gccworld.com/download.php> click the product category and choose proper model.



The screenshot shows a section titled "Or browse by machine model" with three product categories. The "Vinyl Cutter" category is highlighted with a red border. Below the categories is a large blue downward-pointing arrow.

Or browse by machine model

- Vinyl Cutter
- Laser Engraver
- Laser Cutter

Download Area

Vinyl Cutter

Vinyl Cutter



Expert II A



i-Craft™ 2.0



AR-24



Expert II



Puma IV



Jaguar V / Jaguar V (PPF)

6. Download GreatCut-S to start the installation.

Software		
Title	Size	Download
Sure Cuts A Lot Pro 5 _Win64bit	521 MB	Download
Sure Cuts A Lot Pro 5 _Win32bit	34.0 MB	Download
Sure Cuts A Lot Pro 5 _Mac	39.9 MB	Download
SignPal V19	818 MB	Download
GreatCut-S for Windows	303 MB	Download
GreatCut-S for Mac	303 MB	Download

7. Press Next to continue, tick “Launch GreatCut-S” and then press “Finish” to complete the installation.

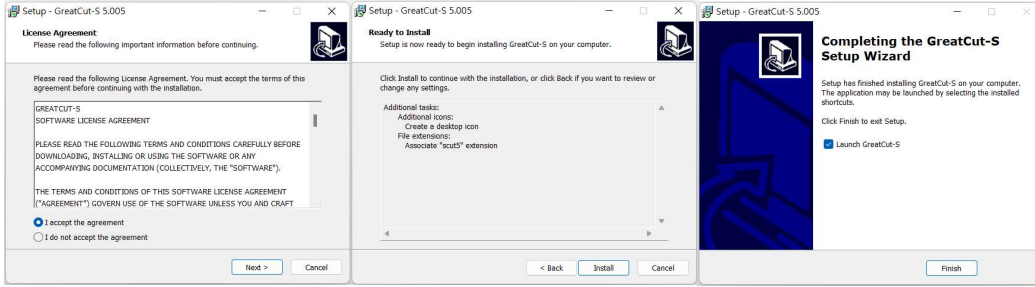

8. Run GreatCut-S and press “Activate...” to activate GreatCut-S. Please make sure it is connected to the internet.

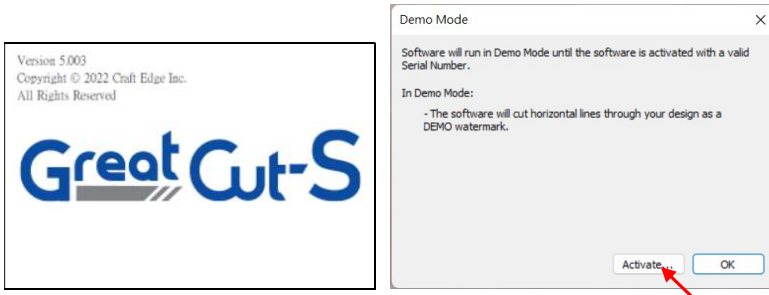

9. Enter your name in the Name column and GreatCut-S serial number to the Serial column and press “OK” to complete the activation.

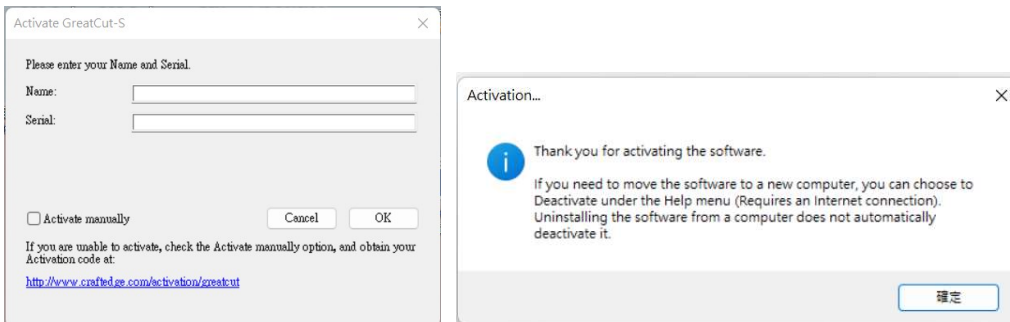

10. GreatCut-S is ready to use.

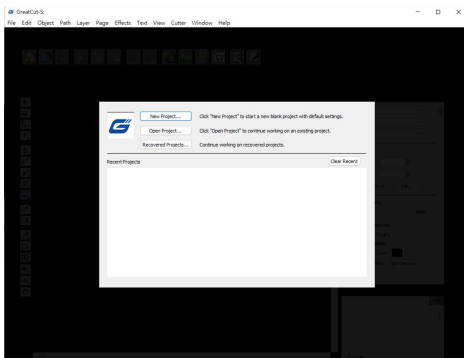

Note

✓ If you use a trial version to output graphics, meaning you do not enter the software key to activate the Sure Cuts A Lot mentioned above, there will be two extra lines cut through the design, therefore, make sure the Sure Cuts A Lot software is activated before implementing cutting jobs.

2.9.1.2 Manual Activation

If the computer connected to the cutter doesn't have an internet connection to complete the software activation process, you can alternatively use the "Activate manually" function to enter the "Activation Code" and begin using GreatCut-S. However, you will need to find another computer with internet access in advance to obtain the "Activation Code" by following the instructions below.

1. Check the "Activate manually" checkbox and you should see the Site Code and Activation Code fields appear. The Site Code field will be pre-filled in and cannot be changed.

2. Visit <https://craftededge.com/activation/greatcut/> via an internet connected computer. Enter your name, serial and site code.



Activate "GreatCut-S"

Important: You only need to do the following if you are having trouble activating from within "GreatCut-S" or do not have an Internet connection on the computer you are trying to activate on.

You must activate in order to use the full version of the software. Generally, you will just need to choose Activate.. from the Help menu in GreatCut-S and enter your name and serial number. The software will try to activate automatically and you can disregard this web page. **Do not** use this web page if you have not installed the software yet or have not purchased.

If you view the About box in GreatCut-S and it shows your name and serial number, the software is activated ok.

If you have problems activating automatically, you must use this web page and generate a Manual Activation Code. The Name and Activation Code information is obtained from your purchase confirmation e-mail. The Site Code is obtained by running the program and choosing "Activate.." and checking the "Activate Manually" option.

After entering in your Name, Activation Code, and the Site Code, click the Generate Activation Code button to create your Manual Activation Code. Copy and paste the value back into the "Activation" dialog box in the application to activate your copy.

3. Click on the "Generate Activation Code" button, and your activation code will be shown in the Activation Code field.

GreatCut-S

Activate "GreatCut-S"

Important: You only need to do the following if you are having trouble activating from within "GreatCut-S" or do not have an Internet connection on the computer you are trying to activate on.

You must activate in order to use the full version of the software. Generally, you will just need to choose Activate.. from the Help menu in GreatCut-S and enter your name and serial number. The software will try to activate automatically and you can disregard this web page. **Do not** use this web page if you have not installed the software yet or have not purchased.

If you view the About box in GreatCut-S and it shows your name and serial number, the software is activated ok.

If you have problems activating automatically, you must use this web page and generate a Manual Activation Code. The Name and Activation Code information is obtained from your purchase confirmation e-mail. The Site Code is obtained by running the program and choosing "Activate.." and checking the "Activate Manually" option.

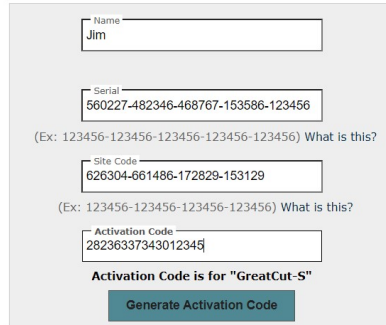

A screenshot of a web form for generating an activation code. It contains four input fields: Name (filled with "Jim"), Serial (filled with "560227-482346-468767-153586-123456"), Site Code (filled with "626304-661486-172829-153129"), and Activation Code (filled with "28236337343012345"). Below the Site Code field is a note: "(Ex: 123456-123456-123456-123456) What is this?". Below the Activation Code field is a note: "(Ex: 123456-123456-123456-123456) What is this?". At the bottom, there is a button labeled "Generate Activation Code" and a line of text: "Activation Code is for "GreatCut-S"".

After entering in your Name, Activation Code, and the Site Code, click the Generate Activation Code button to create your Manual Activation Code. Copy and paste the value back into the "Activation" dialog box in the application to activate your copy.

4. Copy and paste the activation code back into the activation dialog box of Sure Cuts A Lot program and hit ok.

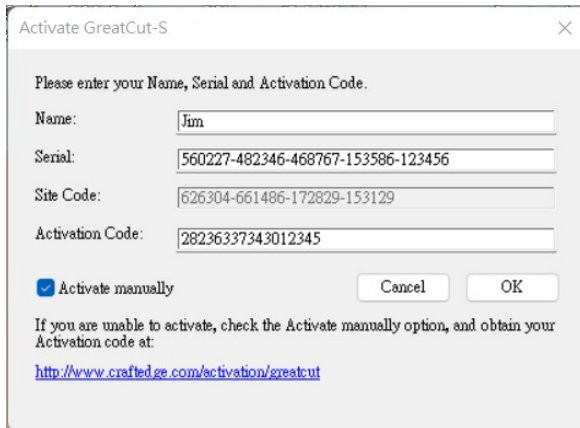

A screenshot of a dialog box titled "Activate GreatCut-S". It contains the following text: "Please enter your Name, Serial and Activation Code." Below this are four input fields: Name (filled with "Jim"), Serial (filled with "560227-482346-468767-153586-123456"), Site Code (filled with "626304-661486-172829-153129"), and Activation Code (filled with "28236337343012345"). There is a checked checkbox labeled "Activate manually" and two buttons: "Cancel" and "OK". At the bottom, there is a message: "If you are unable to activate, check the Activate manually option, and obtain your Activation code at: <http://www.craftedge.com/activation/greatcut>".

5. Click OK and GreatCut-S is ready to use.

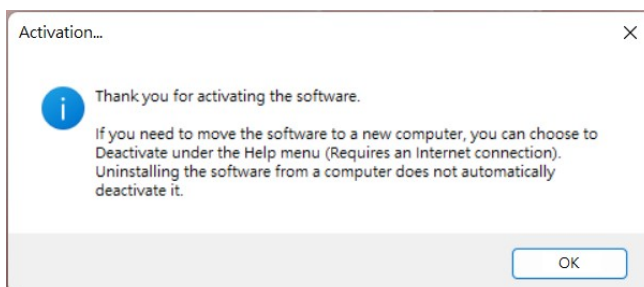

A screenshot of a dialog box titled "Activation...". It contains an information icon (i) and the text: "Thank you for activating the software. If you need to move the software to a new computer, you can choose to Deactivate under the Help menu (Requires an Internet connection). Uninstalling the software from a computer does not automatically deactivate it." There is an "OK" button at the bottom right.

2.9.1.3 Re-install GreatCut-S Software

If you change a new computer, you may need to deactivate your GreatCut-S software and re-install it on your new device.

Go to “Deactivate...” under Help and press Yes to confirm, then follow the installation procedure and use **the same code** to activate it on another computer.

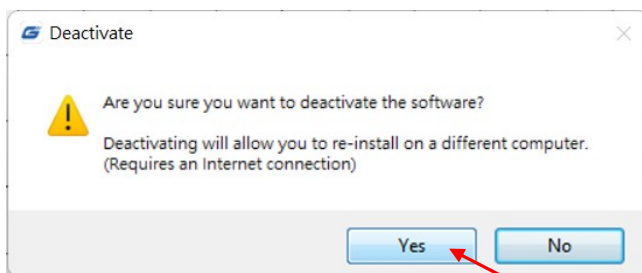
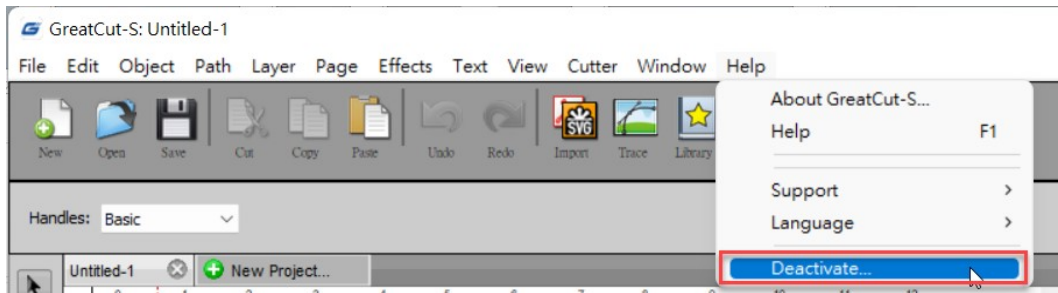

2.9.1.4 Reset GreatCut-S Serial Code

If you need to re-install the software again due to problems such as a computer crash/reformat where you were not able to de-activate your copy off the computer first, you may visit <https://craftedge.com/activation/deactivateGC.php> to reset your serial number

GreatCut-S

Deactivate "GreatCut-S"

This page can be used to reset your serial number if you need to re-install the software again due to problems such as a computer crash/reformat where you were not able to de-activate your copy off the computer first.

If you still have an activated copy installed and you wish to deactivate to install on a different computer, you can choose Deactivate under the Help menu in GreatCut-S instead of using this webpage. The deactivation option in GreatCut-S requires an internet connection.

Important: You will only be able to use this page on a limited basis to reset your serial number. If you need your serial reset again after using this page, you will need to contact GCC Support for help.

IP Address Logged: 180.218.237.36

Name:
 Email:
 Serial:

Please describe the reason you are needing to reset your serial number

Submit

2.9.2 SmartCUT Installation

SmartCUT is a software used for barcode cutting functionality, available for download on the GCC website's download area.

1. Download GreatCut-S to start the installation.
2. Press Next to continue, and then press "Finish" to complete the installation.

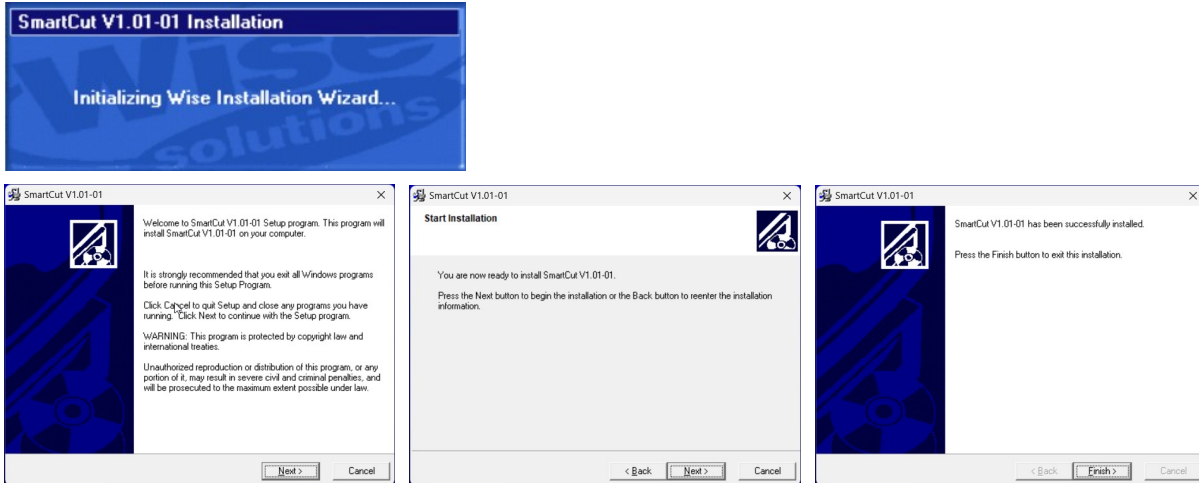

3. Run SmartCUT and it is ready to use.

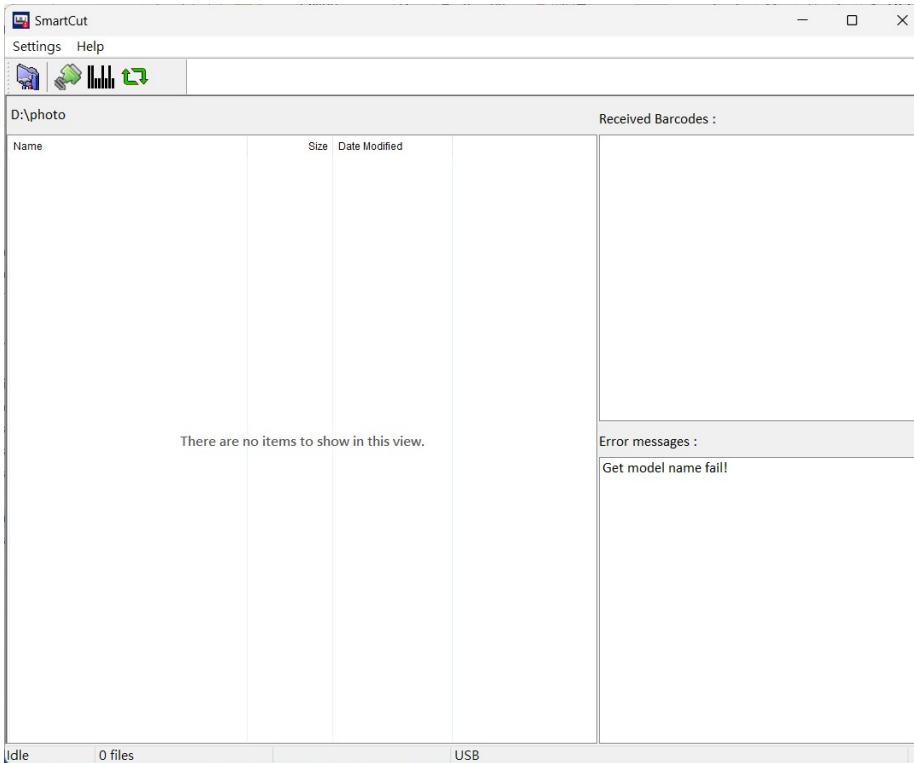

2.10 Auto Cut-off system Installation

Step 1 Unscrew the Cover from the Tool Carriage using a screw driver.

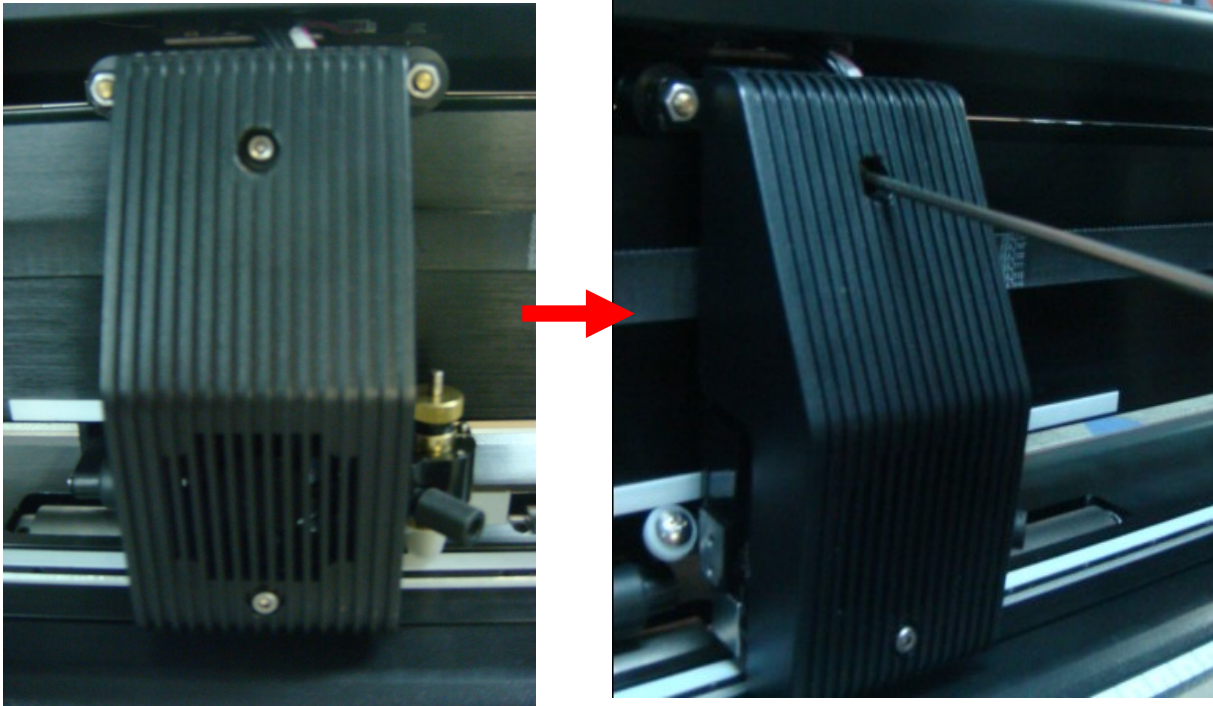

Step 2 Manually disassemble the Cover, which will still be connected to the Tool Carriage through wires.

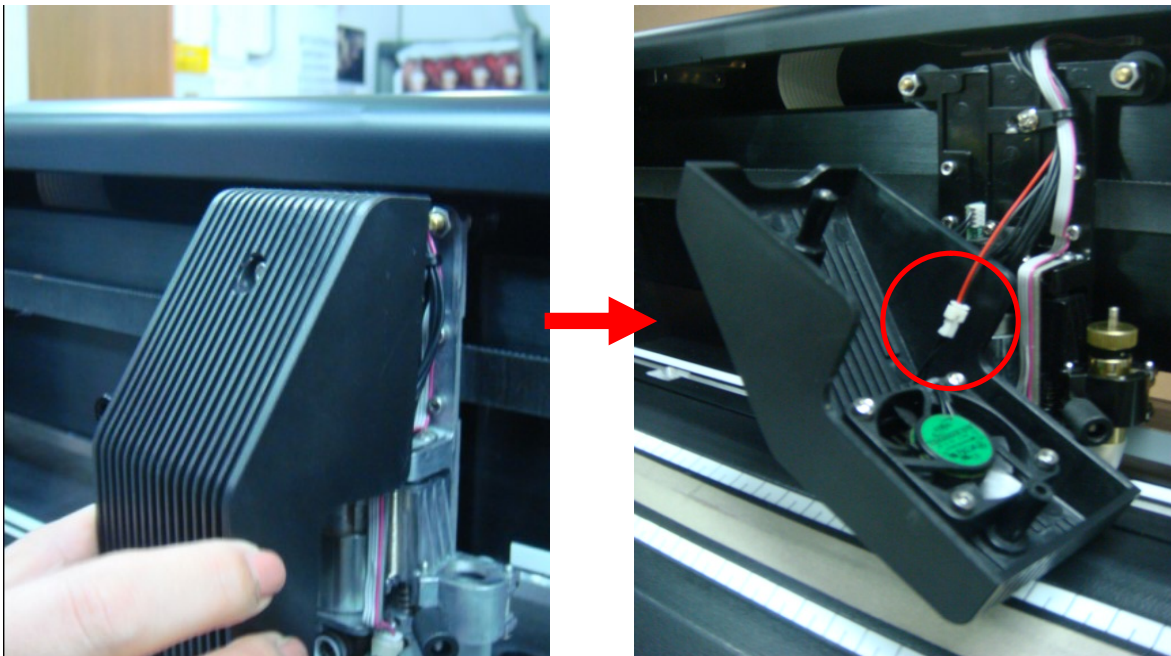

Step 3 Disconnect the black and red wires between the Cover and the Tool Carriage from the white Wire Joint and the Cover will be removed completely.

Note: Please disconnect the wires at the white Wire Joint with care as the fans will not be working if these wires are split elsewhere.

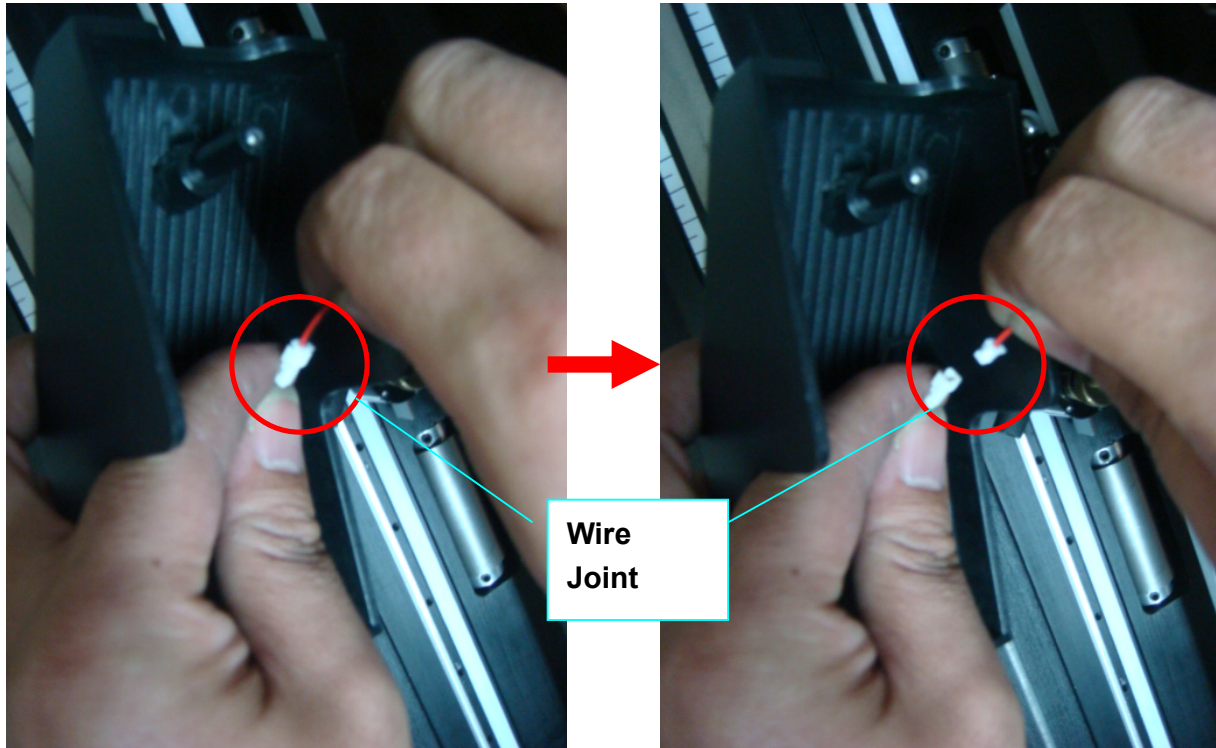

Step 4 Remove the screw on the left of the Cut-off Unit manually (Figure 2-37 and 2-38).

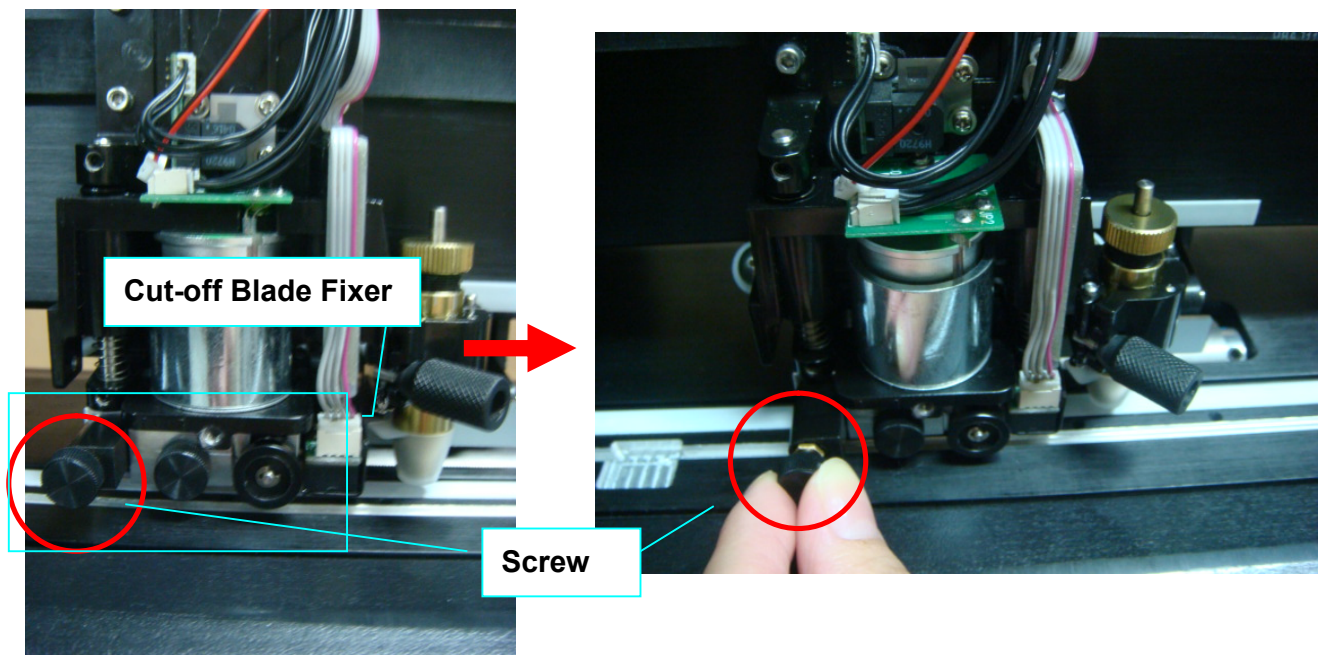

Step 5 Remove the entire Cut-off Unit by holding it while pushing the tiny metal board on the right to the left.

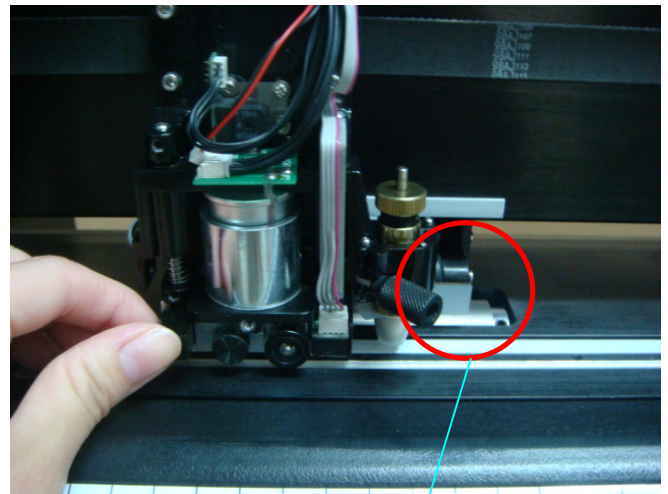
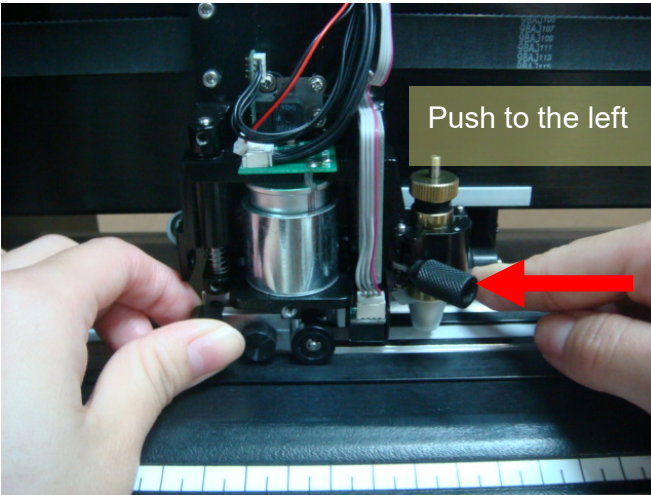

Metal board

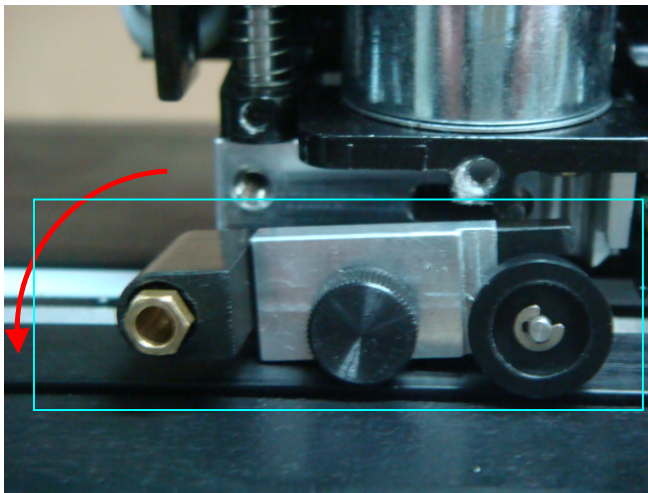
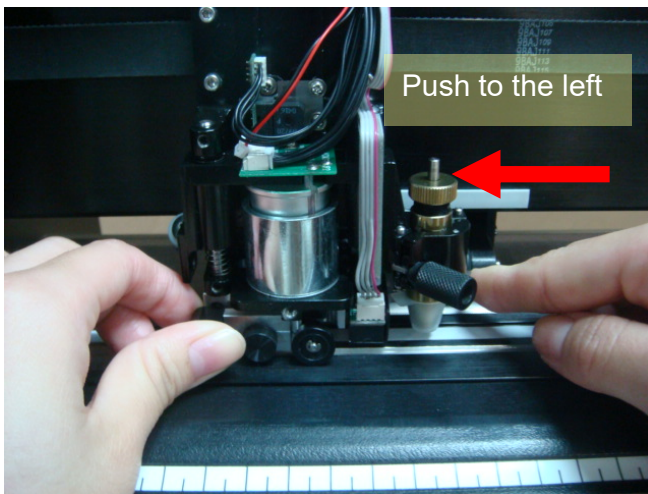

The Cut-off Unit will drop automatically once the board is pushed to the left (above picture).

Step 6 Remove the screw from the Cut-off Unit.

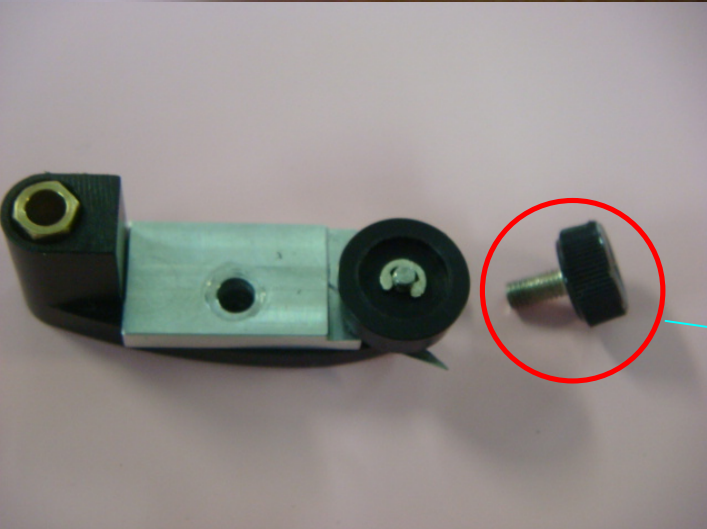
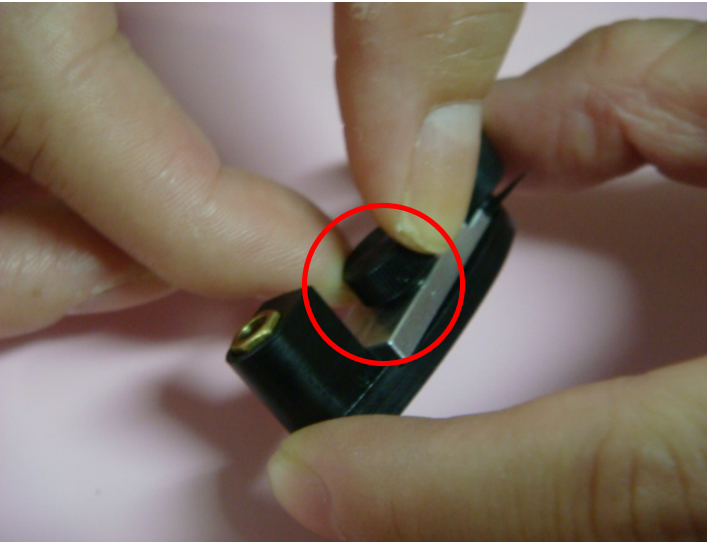

Screw

Disassemble the Cut-off Blade Fixer by pulling it up vertically

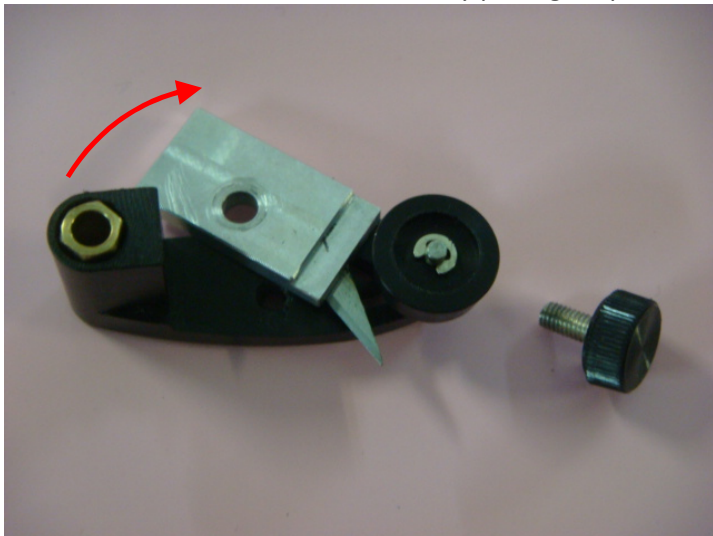

Step 7 Unscrew the Cut-off Blade from the Cut-off Blade Fixer, which will be attracted by the magnet on it, and replace it with a new Cut-off Blade along the track highlighted in red using tweezers.

Note: The Cut-off Blade is sharp so please handle with care.

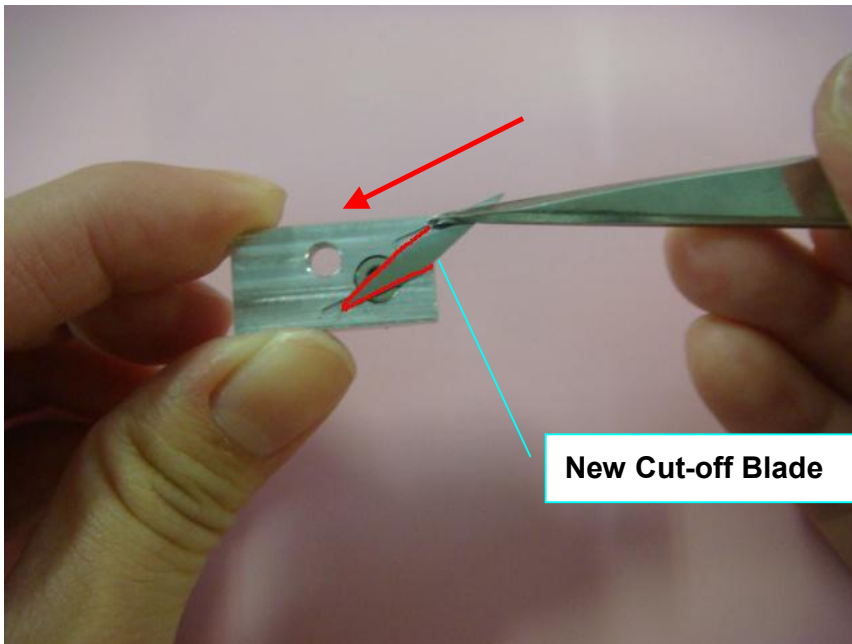
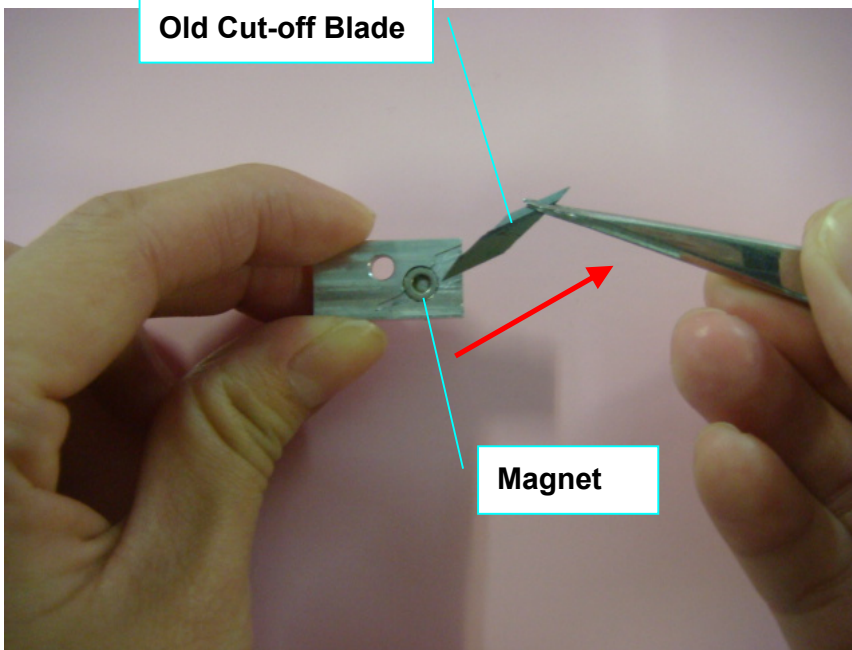

Step 8 Assemble the Cut-off Blade Fixer back to the Cut-off Unit by pushing the Holder downwards.

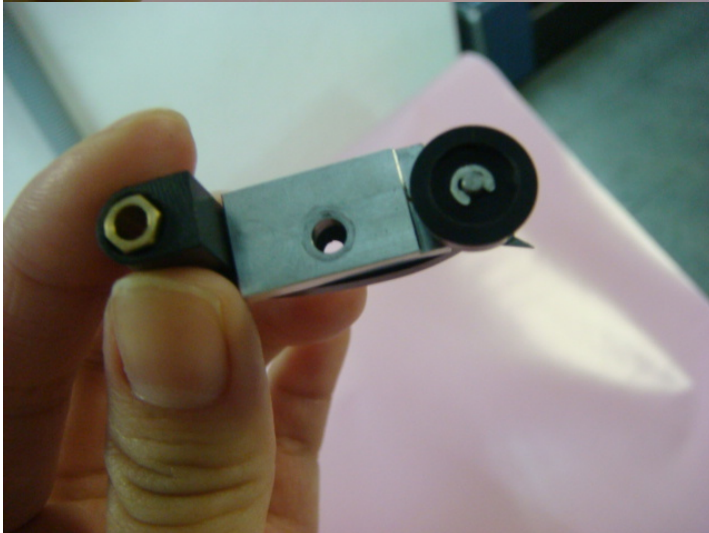
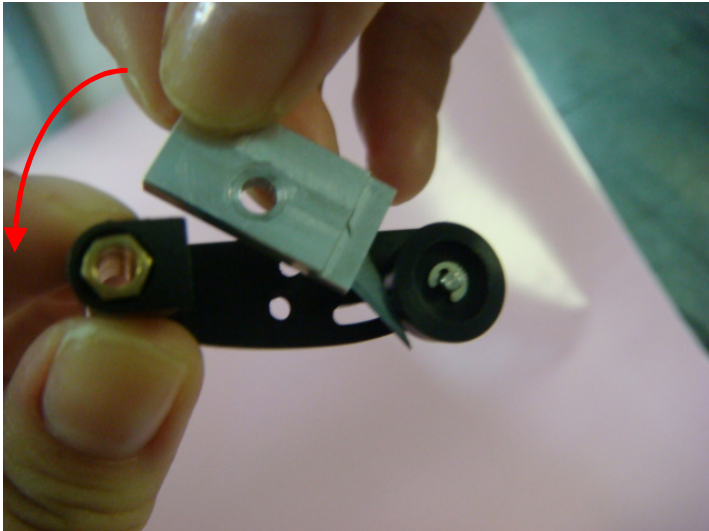

Then attach the screw

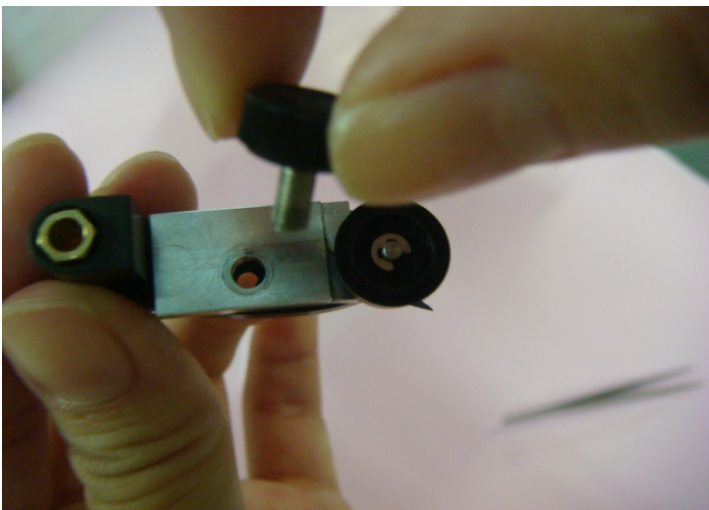

Step 9 Assemble the Cut-off Unit back to the Tool Carriage by pushing the metal board on the right while pushing the Cut-off Unit

upwards.

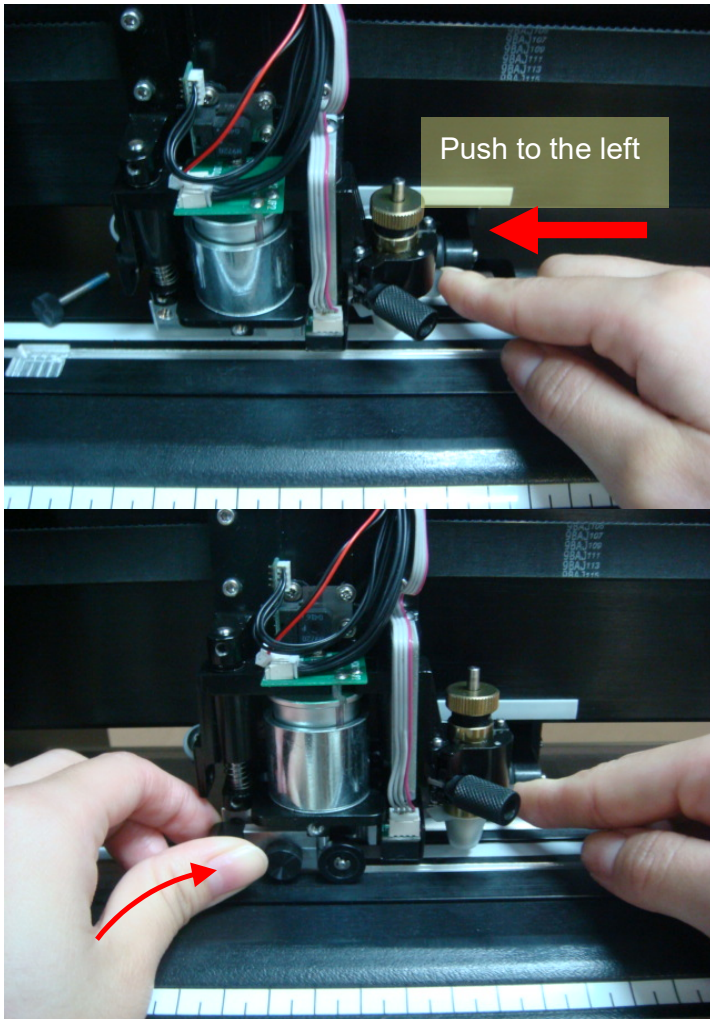

Then attach the screw



Step 10 Reconnect the wires at the white Wire Joint.



Step 11 Assemble the Tool Carriage Cover back to the Tool Carriage; please locate the end of the screw to the hole on the carriage before tightening the screw.

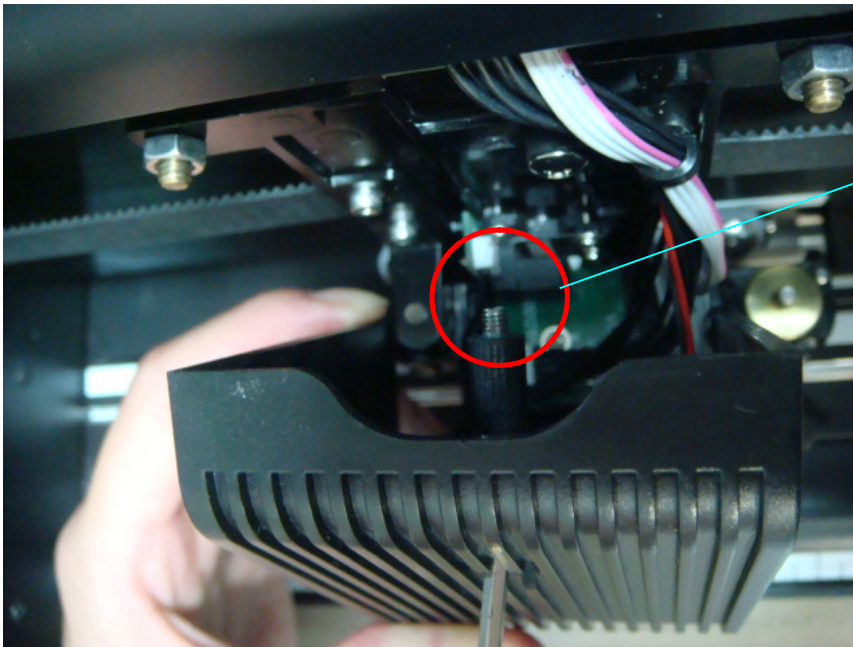

End of Screw

Chapter 3 The Control Panel

This chapter describes the button operations with the LCM menu flowcharts of RX II series. When the cutting plotter is ready for use as described in Chapter 1 & 2, all functions are under default parameters.

3.1 The Touch Key Panel

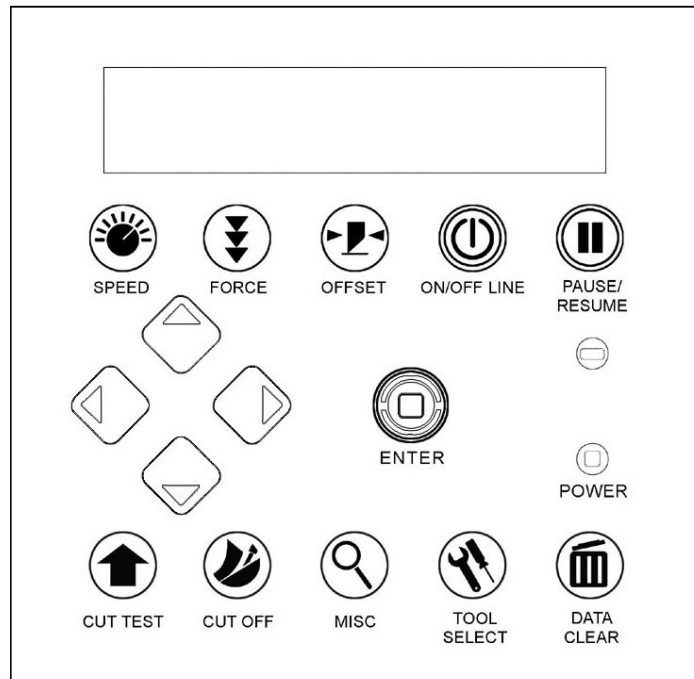

< Touch Key Panel on RX II series >

Key	Function
LCD Screen	To display functions and error messages.
Power LED	To indicate the power status (light up: power on; light off: power off)
4 Arrow Keys	To move position, select function, or change setting.
ENTER	To set item or register the immediately preceding input value.
PAUSE/RESUME	To temporarily halt cutting process or to continue
ON/OFF LINE	To switch modes, stop cutting job, or abort changes of settings.
OFFSET	To adjust the value of blade's offset.
FORCE	To adjust the value of cutting force.

SPEED	To adjust the value of cutting speed and quality.
CUT TEST	To perform cutting test on different media.
CUT OFF	To cut off the material when the job is completed.
MISC	To set up functions.
TOOL SELECT	To select tools.
DATA CLEAR	To clear up internal memory.

Please see details in "3.4 Menu Items"

3.2 Menu in On-line Mode

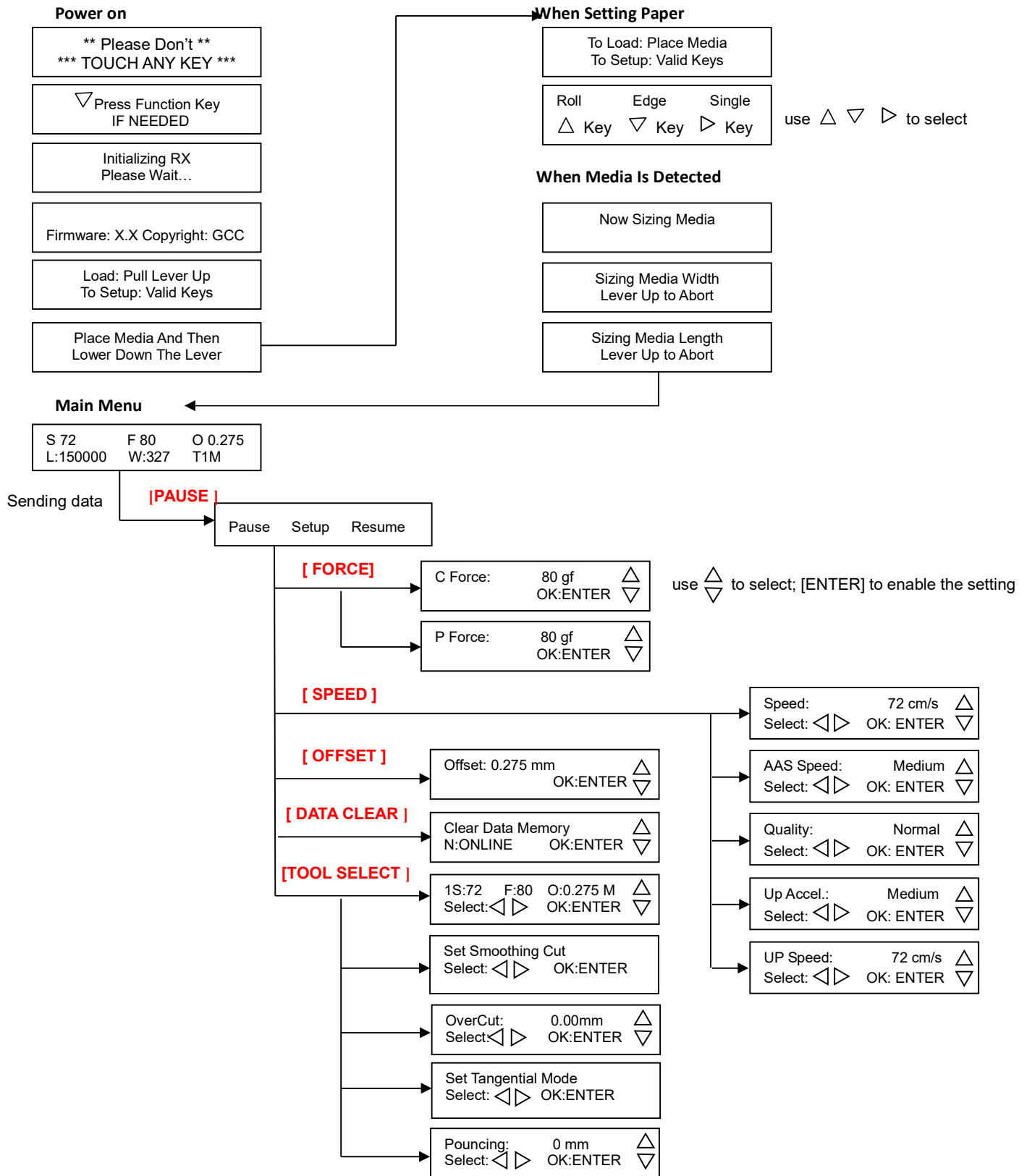

3.3 Menu in Off-line Mode

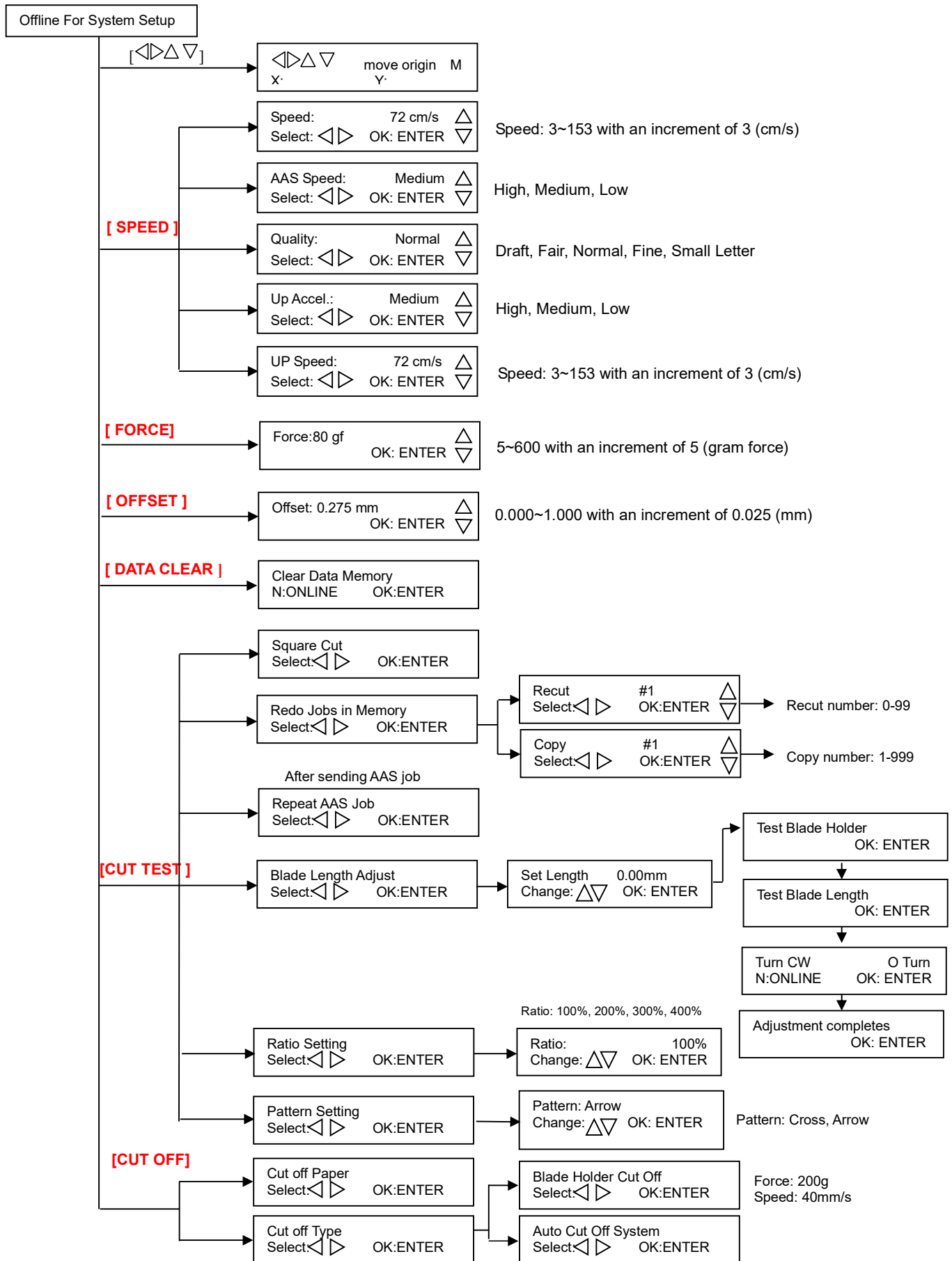

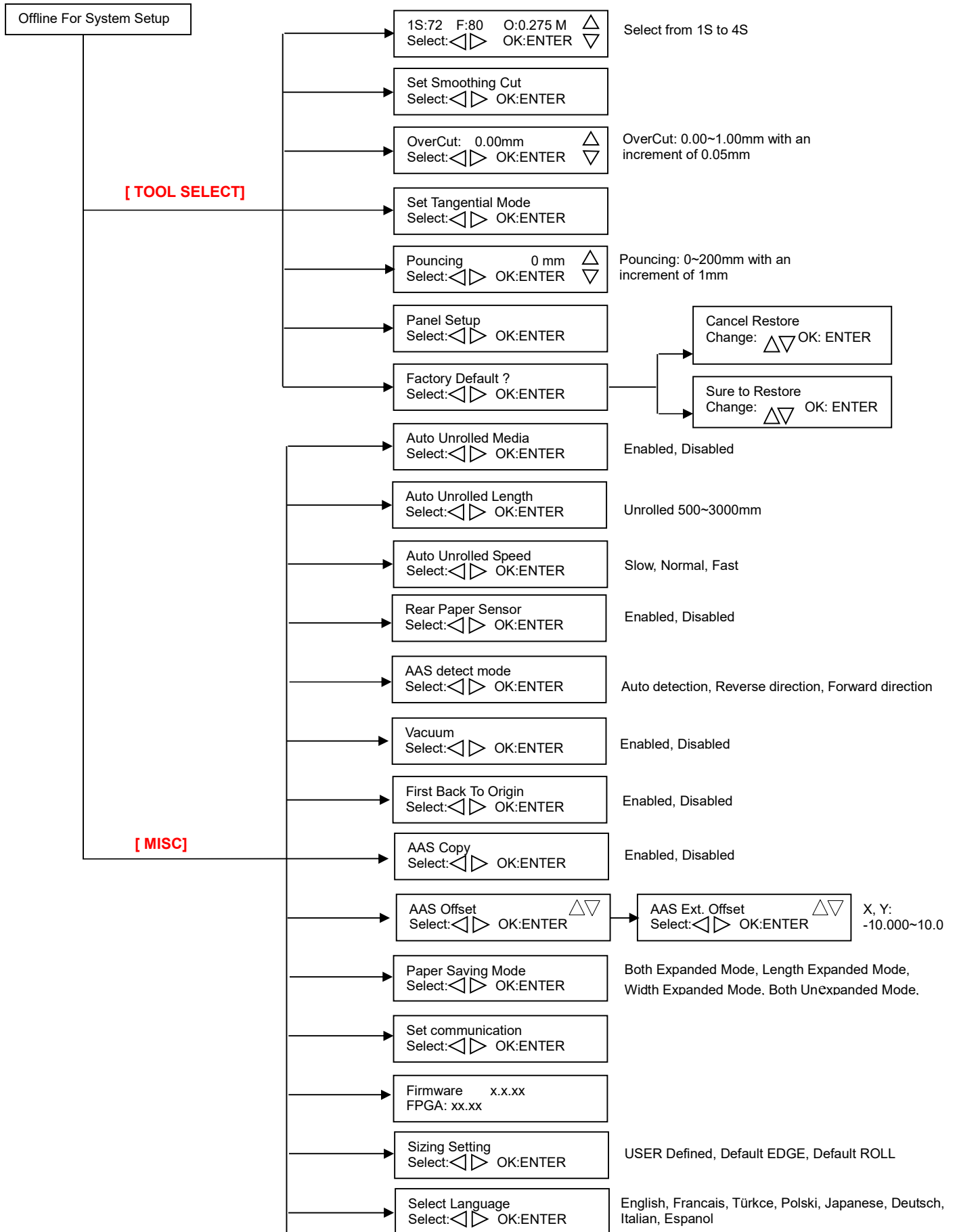

[MISC]

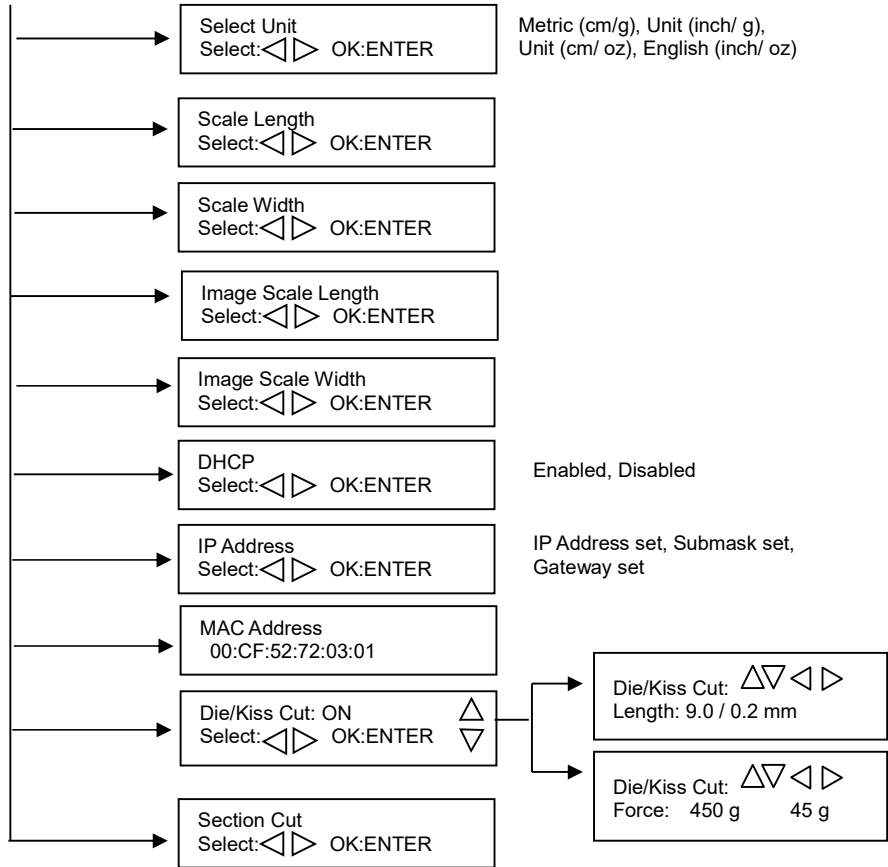

3.4 Menu Items

Below describes the functions of menu items

Menu or Key	Function	Setting	Default
--- Media sizing ---			
Roll	To measure media width.	Maximum Media Length 150M	
Edge	To measure media width and pull the media back till the front paper sensor open.	Maximum Media Length 150M	
Single	To measure media width and length.	Maximum Media Length 10M	
--- POWER ---			
	To indicate the power status.		
[Arrow Keys]			
	1. To move the tool carriage position on X or Y axis. 2. To select functions or change values of settings.		
[ENTER]			
	1. The displayed parameters will be saved automatically. 2. To set a new origin at the present tool carriage position. In "offline" mode, moving the tool carriage to desired position by [Arrow Keys], then press [ENTER] key to set a new origin. While moving with the parameters of XY-axes displayed, press [MISC] key will enable fine-tune movement; press [MISC] key again to disable the function.		
[PAUSE/RESUME]			
	To temporarily halt the cutting process. To resume the process by press [Pause/Resume] key again.		
[ONLINE/OFFLINE]			
	1. To switch between online mode and offline mode. 2. To stop the cutting job or abort the change of setting. Once press this key, the cutting job will be terminated immediately and cannot be resumed.		
[OFFSET]			
	To set or modify the distance between the blade tip and the center axis. Through left or right arrow keys, users can select the blade used (Red, Green, Yellow, Blue, Black capped blade or Pen) then adjust the offset values after pressing Enter if necessary	0.000~1.000mm	0.275mm
[FORCE]			
	To set or modify the value of tool force. When the cutting force exceeds 450g, the maximum cutting speed would be 15 cm/sec and the cutting quality would be Small Letter Mode and while the cutting force is 300g-449g, the maximum cutting speed would be 30 cm/sec and the cutting quality would be Fine Mode.	5~600gram; 5 gram/per step	80 gram
[SPEED]			
Speed	To set or modify tool speed at horizontal moving. When the cutting speed exceeds 72 cm/sec, the cutting quality would be Normal Mode.	3~153cm/sec; 3cm/sec per step	72cm/sec
AAS Speed	To set or modify AAS detecting speed.	High, Medium, Low	Medium
Quality	To set or modify cutting quality (acceleration). Draft (4.2G), Fair (2.8G), Normal (1.4G), Fine (0.7G), Small Letter (0.2G). While cutting small letter, set as "Small letter".	Draft, Fair, Normal, Fine, Small Letter	Normal

	While cutting in high speed, set as "Draft". For normal operation, set as "Normal".		
Up Accel.	To set or modify tool acceleration at vertical moving.	High, Medium, Low	Medium
Up Speed	To set or modify tool speed at vertical moving.	3~153cm/sec; 3cm/sec per step	72cm/sec
[CUT TEST]			
Square Cut	To perform a cutting test at present blade position. For more information, please refer to "4.3 Adjusting the Cutting Force and Offset" to adjust blade force and cutting speed.		
Redo Jobs in Memory	To redo the cut test jobs saved in memory by recutting or producing cut test copies	Recut (number of jobs: 1-99) Copy (number of jobs: 1-999)	Recut
Repeat AAS Job	To repeat AAS jobs automatically without having to operate on the computer side. Please be noted that this feature is mainly applied to the Single paper mode; please ensure a new piece of material you wish to apply this feature on is loaded and the origin repositioned to the first registration mark before starting. When the first AAS job repeat completes, the user will be offered the choice of "Repeat AAS Job Again", please press "Online/Offline" to return to the main menu.		
Blade Length Adjust	To adjust the length of the blade Note: 1. Keep your blade length as 0 before you start adjusting. 2. Test the blade holder first and then test the blade length by pressing ENTER. 3. Keep the blade holder at the same position when you perform blade holder and blade length tests. 4. When blade holder and blade length tests are finished, the screen will show you to what degree (the unit of the value following "CW" or "CCW" is "circle") and in which direction [CW (clockwise) or CCW (counterclockwise)] you should turn the adjustment knob. EG, Turn CW 0.5 is telling you that you should turn the knob for half a circle clockwise. 5. The value on the screen will be 0.0 when the blade length is perfect and no more adjustment needs to be made. You will be prompted with the message below: Adjustment completes and you may start cutting at this point.	0.00mm-5.00mm	0.00mm
Ratio Setting	To adjust the size of the pattern.	100%, 200%, 300%, 400%	100%
Pattern Setting	To provide two patterns for cut test Note: It is recommended to select "Cross" if you are working on thick pieces of materials.	"Arrow" and "Cross" patterns	"Arrow"
[DATA CLEAR]			
	To clear up buffer memory.		
[TOOL SELECT]			
Save Parameter	To save pattern(s) of cutting parameters for later use. There are 4 sets of parameters saved in the panel. Use Page Up and Page Down keys to select the set of parameters you wish to adjust, press "Enter" to confirm (the number shown on the upper left corner will change accordingly). Each set of parameters includes Speed, Force, Offset, Up Speed, Quality and Scaling though the latter three will not be displayed in this section. To	Pattern 1: vinyl Pattern 2: window tint Patterns 3 & 4:	Patterns 3 & 4

	adjust or check individual parameters, go back to the responding keys on the panel and press "Enter" to confirm.	default value which could be adjusted if needed	
Set Smoothing Cut	To enable smooth-cutting function.		Enable
Over Cut	To generate an overcut to facilitate weeding.	0.00mm-1.00mm 0.05mm/per step	0.00mm
Set Tangential Mode	To enable the tangential-cutting mode for thicker media types and small letter cuts. Note: while the Offset value setting at 0.000 mm, "Set Tangential Mode" will automatically be disabled.		Enable
Pouncing	To make perforated patterns. * In order to use this function, Pouncing tool must be installed. * Before start pouncing, place pouncing strip on top of the cutting pad to protect the cutting pad. * Set the value as 0 mm to disable the pouncing mode. * Pouncing tool is an optional item.	0~200mm	0mm
Panel Setup	Accept setup command: To accept commands of the Force, Speed, Cutting Quality, and Offset only via software.		Accept setup command
	Control panel only: To accept commands of the Force, Speed, Cutting Quality, and Offset only via control panel of the cutter.		
Factory Default?	To turn all parameters of the menu items to factory-default settings.		
[MISC]			
Auto Unrolled Media	To avoid paper jam and motor crash by automatically unroll media (50cm and up) before cutting while enabled. * Auto-unroll only effects on roll/edge media. * Using Single mode to size media will disable this function automatically. * If the length of the rolled media is less than 2 meters or the weight is light, it is recommended to set this mode disabled.		Enabled
Auto Unrolled Length	When "auto unrolled media" is enabled, user can adjust the unrolled media length.	500~3000mm	3000mm
Auto Unrolled Speed	To adjust the unrolled media speed.	Slow, Normal, Fast	Normal
Rear Paper Sensor	To detect if the rear paper sensor is covered to determine the following process; when it is enabled, the cutter will detect if the material has covered the rear paper sensor under the Roll and Edge mode; when disabled, the rear paper sensor will not be functioning. Note: Rear paper sensor only functions under "Roll" and "Edge" mode.	Enable Disable	Enable
AAS detect mode	To recognize the printed sheet media is fed in forward direction or reversed direction by detecting the registration marks. 1. Forward direction: to detect the registration marks in forward media feeding direction 2. Auto detection: to distinguish the media feeding direction automatically by detecting the registration marks. 3. Reverse direction: to detect the registration marks in reversed media feeding direction		

Vacuum	To help improve tracking and cutting accuracy by turning on the fans. If you turn off the vacuum system, the fans will remain inactive during cutting or plotting.	Enable, Disable	Enable
First Back to Origin	To enable the carriage back to the previous origin; when "Enable" is selected, the carriage will not go back to the previous origin while the selection of "Disable" allows the carriage to do so.	Enable Disable	Enable
AAS Copy	To enable the AAS copy. When "Enable" is selected, the AAS module will continue to read the registration mark to contour cut. Users can set distance between images and AAS copy times in this function. The range of distance is 0-500mm, and the range of times is 0-1000.	Enable Disable	Enable
AAS Offset/ AAS Ext. Offset	To set or modify AAS offset value. You can refer to "5.3 Printer Test" for more details. Adjust the offset value under AAS Offset menu when a regular blade holder is installed; adjust the offset value under AAS Ext. Offset menu when an extension holder is installed.		AAS Offset: X:0, Y:0 AAS Ext. Offset: X:8.5, Y:3
Paper Saving Mode	To save media by four different modes: 1. Length expanded mode 2. Width expanded mode 3. Both expanded mode 4. Both unexpanded mode		Length expanded mode
Set Communication	To build up the communication between host computer and cutter. <i>Baud Rate</i> is to determine the speed of data transmission. <i>Data Bits</i> refers to the size of one block of data. <i>Parity</i> is used to check if data was received correctly or not. 9600, n, 7, 1, p 9600pbs, 7 Bits with NO Parity 9600, o, 7, 1, p 9600pbs, 7 Bits with ODD Parity 9600, e, 7, 1, p 9600pbs, 7 Bits with EVEN Parity 9600, n, 8, 1, p 9600pbs, 8 Bits with NO Parity 9600, o, 8, 1, p 9600pbs, 8 Bits with ODD Parity 9600, e, 8, 1, p 9600pbs, 8 Bits with EVEN Parity 19200, n, 7, 1, p 19200pbs, 7 Bits with NO Parity 19200, o, 7, 1, p 19200pbs, 7 Bits with ODD Parity 19200, e, 7, 1, p 19200pbs, 7 Bits with EVEN Parity 19200, n, 8, 1, p 19200pbs, 8 Bits with NO Parity 19200, o, 8, 1, p 19200pbs, 8 Bits with ODD Parity 19200, e, 8, 1, p 19200pbs, 8 Bits with EVEN Parity		
Firmware Version	To display the version number of Firmware and FPGA code, varying from model to model		
Sizing Setting	Allows user to set the sizing settings. If set to user defined mode, the user will be asked to select the size setting every time the machine is turned on. If set to Default Edge or Roll, Edge or Roll type sizing will be performed whenever the machine is turned on.	User Defined, Default EDGE, Default ROLL	User Defined
Select Language	To select displayed languages on LCM panel in English, Spanish, Italian, Deutsch, Japanese, Portuguese, Polish, Turkish or French.		English
Select Units	Provide four-unit systems for users convenient.	cm/s; inch/oz; cm/oz; inch/gram	Metric
Scale Length Scale Width	Fixed scaling, for maintenance only.		
Image Scaling Length	To adjust the image scale of media length and width that may cause by the thickness of the media. The Numerator is the ideal length, and the Denominator is the actual length measured from the resultant.		

Image Scaling Width	For example, cutting a line with 500.0 mm length. The procedure as follows: 1. Press the [LEFT ARROW] to choose the Numerator and select 500.0 mm, 2. Cut the length by sending a graph file, 3. Measure the length then use the [RIGHT ARROW] key to choose the Denominator, then 4. Press [UP ARROW /DOWN ARROW] to change the values of the actual length.		
DHCP	Shows your IP address for TCP/IP Configuration		Disable
IP Address	Shows the IP Address of your cutting plotter.		
MAC Address	Shows the MAC Address of your cutting plotter.		
Die/Kiss Cut	To perform die cut/kiss cut in one cutting line simultaneously by designating the outline to green color RGB 255 and defining the length and force setting on control panel (Please refer to Chapter 4.9 for details).	Length: 0.2 ~9mm Force: 45 g~ 450 g	
Section Cut	To divides the long plot data into sectional output jobs to gain higher cutting quality and increase precision. Users can set the section by registration marks or input the value manually.		
[CUT OFF]			
Cut off Paper	To cut off the material automatically when the job is completed, you need to use the arrow keys to move the carriage to the position you want to cut off the material and then press the "cut off" button and the auto cut off system will cut-off the material.		
Cut off Type	To perform auto cut-off by auto cut off system or Blade holder cut off. Users can define the cut off force/speed when Blade holder cut off is selected. Note: Blade holder cut off function is using a blade to cut-off the material. An extension holder and a blade holder with blade are required to perform the Blade holder cut off function.	Auto cut off system, Blade holder cut off	Auto cut off system

Chapter 4 Operation

4.1 Media Loading

4.1.1 Loading the Sheet Media

To load the media properly, please follow the procedures listed below:

Step 1

Use the lever on the upper right side of the cutting plotter to raise or lower down pinch rollers. Pull the lever forward until it makes a clicking sound then the pinch rollers are raised (Figure 4-1).

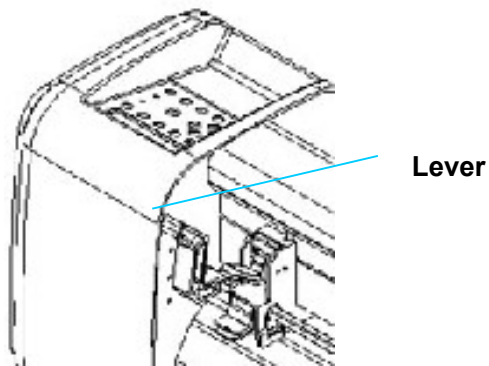

Figure 4-1

Step 2

Load your media on the platen and slide it under the pinch rollers from either the front side or the backside. The **alignment rulers** on the platen extension will help you to adjust the media precisely.

Note:

Be sure that the media must cover the paper sensors on the platen when loading the media. At least one of the two paper sensors (Figure 4-2) should be covered. Once the media covers the sensor, the cutting plotter will size the media width and length automatically.

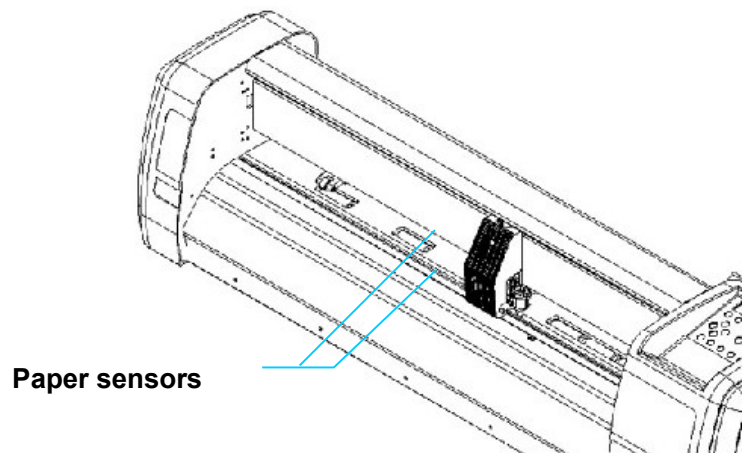
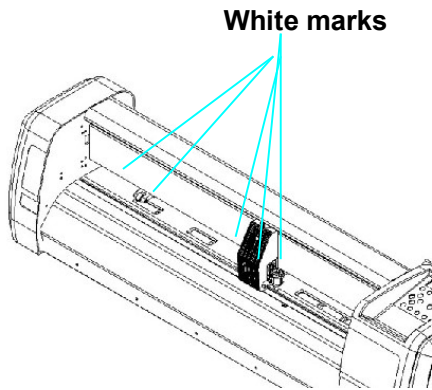

Figure 4-2

Step 3

Then move the pinch rollers manually to the proper position. Be sure the pinch rollers must be positioned above the grid drum. The **white marks** on the top trail will remind you where the grid drums are (Figure 4-3).

**Figure 4-3****Step 4**

Push the lever backward to lower down the pinch rollers.

Step 5

Turn on the power, the tool carriage will measure the size of the media automatically. And the plotting cutter begins to work.

Note:

Always adjust the position with the pinch roller raised.

Move the pinch roller by applying force at the rear portion of the pinch roller support.

Do not move it by holding its front rubber roller (Figure 4-4).

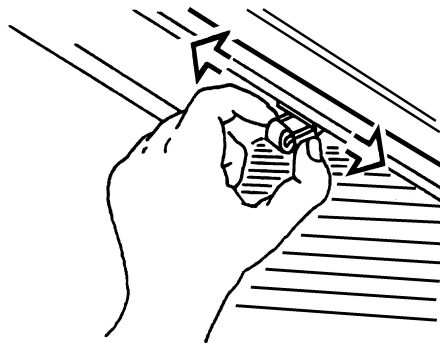
**(X)****Incorrect****Figure 4-4**

Note:

Please pull up the bottom of all pinch rollers (Figure 4-5) before the lever is pushed backwards to ensure accurate media width detection.



Figure 4-5

4.1.2 Loading the Roll Media

Step 1

Put the roll media guide bushes on two roll holders (Figure 4-6).

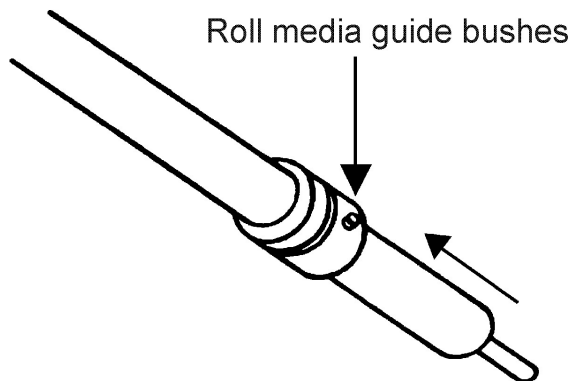

Figure 4-6

Step 2

-- Option A (Use the media flanges) (Recommended)

Insert a roll media flange at the end of each roll media and tighten the thumbscrew until the roll media is firmly gripped (see Figure 4-7).

Then put the roll media on the roll holders. Adjust the position of the roll media ensure that media flanges are able to run in the grooves of roll holder guide bushes (Figure 4-8)

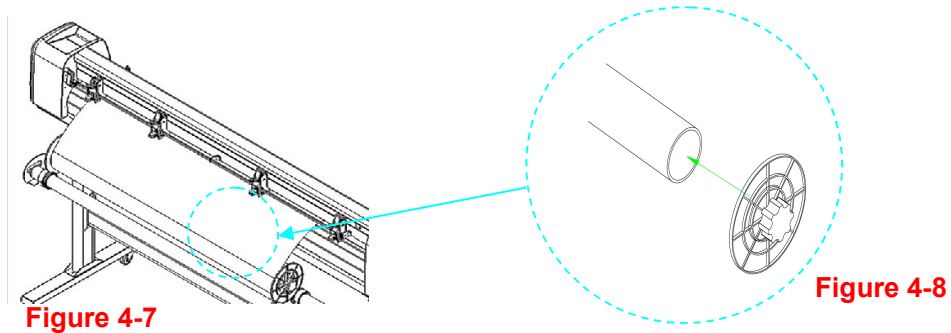

-- Option B

Insert the two roll holders into the roll media support set then place the roll media directly between the two roll holders (Figure 4-9).

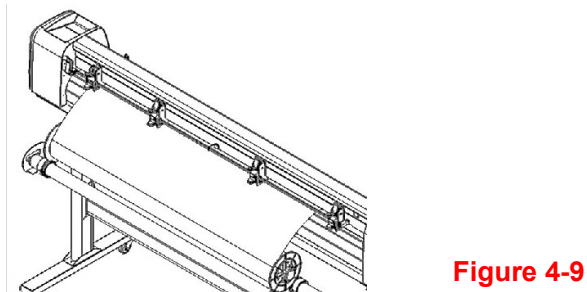

Step 3

Load the media on the platen. Please refer to “4.1.1 Loading the sheet media”. After loading the roll media, flatten the media on the platen and hold the front edge of the roll media firmly (Figure 4-10).

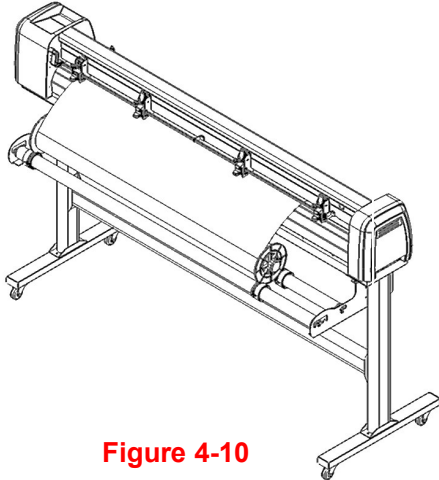

Figure 4-10

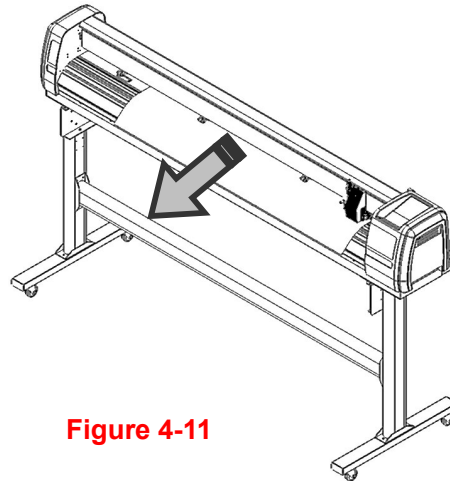

Figure 4-11

Step 4

Turn the roll downward to make an equal tension across the media (Figure 4-11)

Step 5

Move the pinch rollers to the appraise location and note that the pinch rollers must be positioned above the grid drums.

Step 6

Push the lever backward to lower down the pinch rollers.

Step 7

Fix roll holder guide bushes on the roll holder to secure the roll media.

Step 8

Turn on the power switch and select Roll, Edge or Single mode appropriate for one time setup, or set to Default Roll in Sizing Setting and Roll type sizing will be performed when the machine is turned on. Then the cutting plotter is ready to work.

Step 9

Use the reverse steps to remove the media.

Note:

Make sure that the media tension is equally distributed from left to right. If the media were not tightened enough against the platen, it would cause tracking problems!

4.2 Tracking Performance

In order to achieve the best tracking performance for a long plot, we recommend some significant media loading procedures described as follows:

If the media length is less than 4 meters, leave the margin of 0.5mm—25mm in the left and right edges of the media (Figure 4-12).

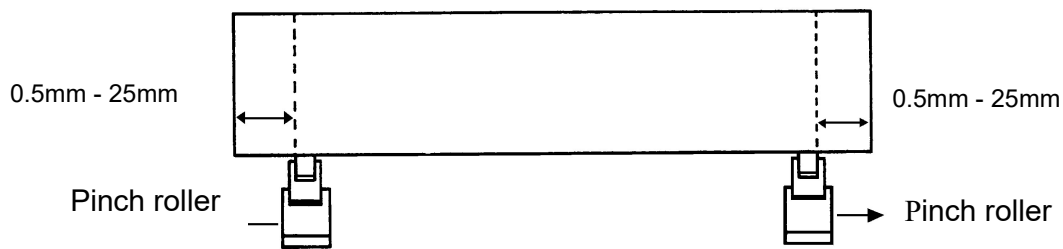

Figure 4-12

If the media length is greater than 4 meters, leave at least 25mm margin on the left and right edges of the media (Figure 4-13).

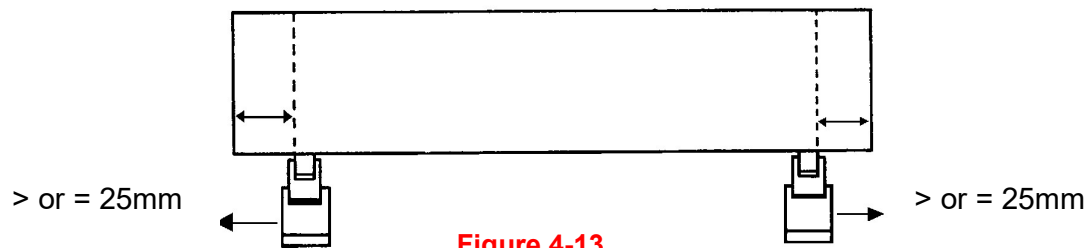

Figure 4-13

Please refer to the paragraph “4.5 How to Make A Long Plot” for more details.

4.3 Cutting Force and Offset Adjustment

Before sending your designs for cutting, you may perform a “cut test” to generate satisfactory cutting results. The “Cut Test” should be repeated until the appropriate cutting conditions for the media are discovered.

After sizing the media, press [CUT TEST] button to select the “square cut”, and press [ENTER KEY] to confirm.

The default cutting force and offset value of the cutting test are 80gf and 0.275mm respectively. Press [ARROW KEY] to move the tool carriage to the position where you like. Then, press the [ENTER KEY] to perform Cut Test.

Note: At the same time, the new origin is also set at the cutting test position.

When the cutting test is completed, a pattern appears. Peel off the pattern to see if it can be easily separated from the media base. If yes, the setup tool force is appropriate. If not or cut through the back paper, press [FORCE KEY] to adjust the tool force until an optimum force is obtained (Figure 4-14).

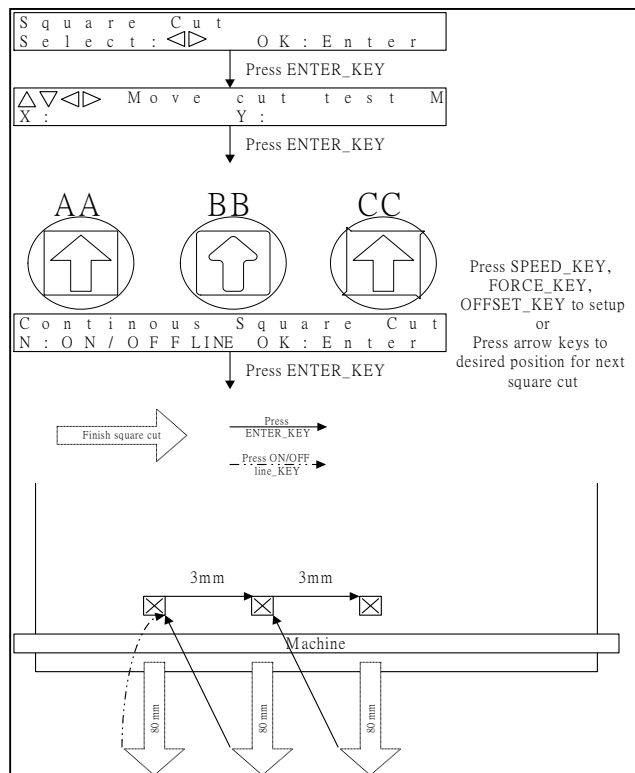

If the pattern appears to be BB or CC layout, press [OFFSET KEY] to adjust the offset value until AA pattern discovered.

Figure 4-14

4.4 How to Cut 3mm Letters

To obtain good quality output, narrow media is recommended. However, if wide media is used, you should:

1. Position two pinch rollers as close as possible to both edges of the cutting area.
2. Make sure the loaded media is held flat with equal tension across the platen.
3. Suggested operation settings:

Tool force: 55 gf. (or depending on the material)

Cutting speed: 45-50 cm/sec

Tool up speed: 45-60 cm/sec

Smooth cut: Disable

Quality: Small Letter

4.5 How to Make a Long Plot

When you are making a long plot with a roll of heavy and wide vinyl, paper you need to use the "AUTO UNROLL MEDIA" function. The following parameter settings are to help users get the best cutting quality. The actual output quality may vary when using different kind of materials

1. If the length of graphic is between 3m and 5m, the cutting speed is better slower than 72cm/sec and the cutting quality is set as Normal.
2. If the length is longer than 5m or if the material type is difficult to cut, it is better to further slow down the cutting speed.
3. After loading the roll media all pinch rollers are raised at this stage, flatten the media on the platen and hold the front edge of the roll media firmly (Figure 4-15).

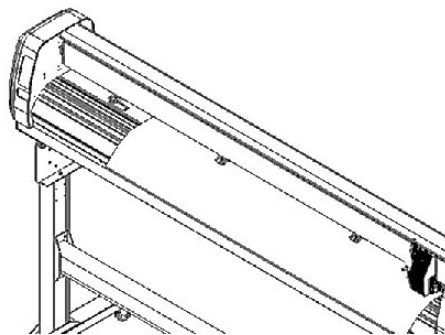

Figure 4-15

Then turn the roll downward to make an equal tension across the media
(See Figure 4-16)

Make sure that the media tension is equally distributed from left to right. If the media is not tight enough against the platen, it will cause tracking problems.

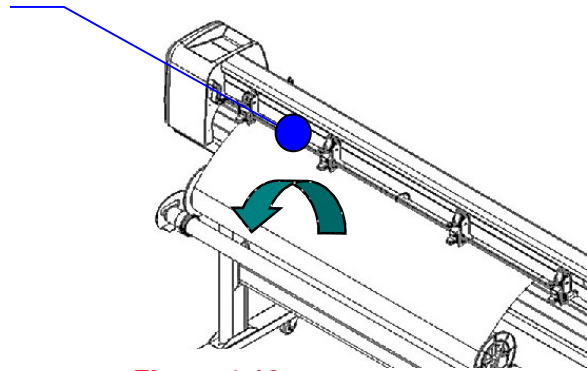

Figure 4-16

4. Engage pinch rollers.
5. Fixes roll media guide bushes on the roll holder to secure the roll media.
6. The protrusion length of the blade should be longer than the thickness of the vinyl.
(Please check the “Blade Specification: About the Tool” in Appendix.) After you notice all the above, you’ll enjoy your gigantic signs production!

4.6 When Completing the Cutting Job

After completing the cutting job, raise the sheet-loading lever, and then remove the material. You can also cut off the finished job by the Safe Blade (a standard accessory) along the knife guide. (Figure 4-17). Or move the carriage to the position you want to cut off the material and then press the “CUT OFF” button on the control panel. The material will be cut off automatically.



Figure 4-17

4.7 RX II series Print Driver setting

4.7.1 RX II series Print Driver setting > Option Page

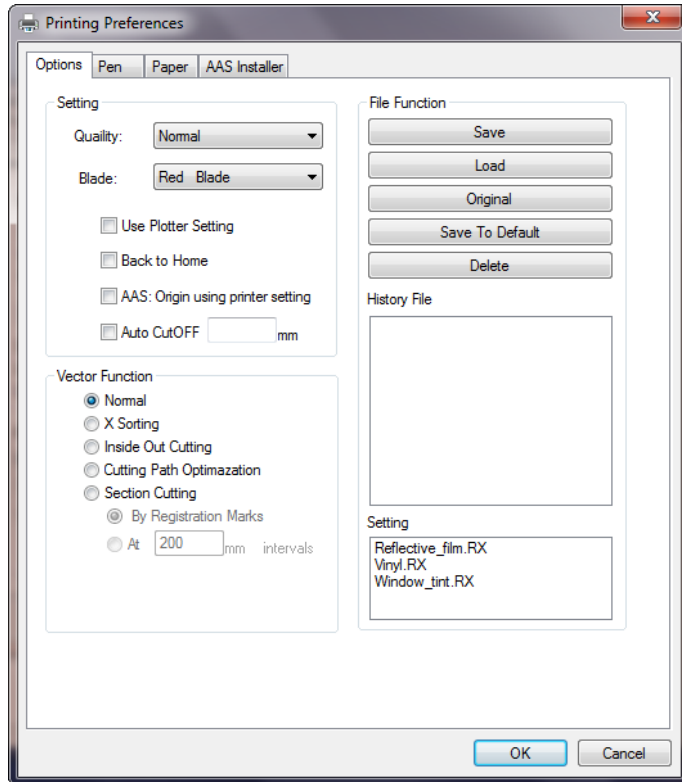

Setting: You can adjust the following settings, depending on your application or results you would like to achieve.

Quality:

[Slower speeds / higher quality - Faster speeds / lower quality]

The Cutting Quality setting function allows you to adjust and balance vector mode's quality and speed settings based on your specific job. Draft Mode offers the highest output speed, sacrificing quality. Whereas Small letter Mode offers the highest quality, sacrificing output speed. Keep in mind that speed and quality are usually at a tradeoff.

Blade:

Choose the blade type used for this job.

Use Plotter Setting:

The parameter settings will be set according to those set from the control panel.

Back to home:

The carriage will return to the original position when this option is selected.

Auto Cut off:

This feature allows users to set the cutter to cut off the media after the completion of each job making it easy to set up an unattended workflow for mass production. The material will be cut off automatically once you click the Auto Cut off function on GCC driver and set the distance between the cutting image and the cut off line.

The default is 10mm meaning the material will be cut off after 10mm of the image. The value for the cut off function is adjustable. You can set the value between 0mm-100mm depending on your need.

Vector Function**1. Normal:**

This is the default Vector Function setting. The cutting order depends on the order of the graphics created in the application software.

2. X sorting:

The cutting order is based on the next closest object on the x-axis from the origin. The cutting order of the sample below will be 1,2,3,4 (please refer to figure 4-20).

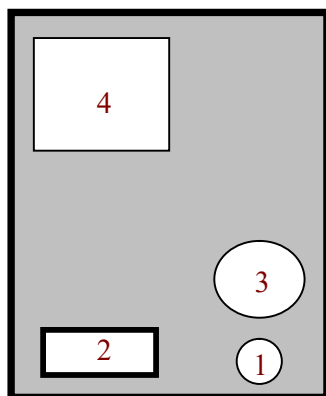

Figure 4-19

3. Inside Out Cutting:

When performing a vector cutting job in which your image has one vector cut area enclosed within another vector cut area, select the Inside-out Sorting mode. This mode will automatically instruct the print driver to process the inside vector image and moving outwards. This setting will always automatically direct the cutter to cut from the inner most vector shape and move outwards.

4. Cutting Path Optimization:

This is a setting that will minimize your process time. When selected, the print driver will analyze your image and automatically determine the most efficient processing path to process your image.

5. Section Cutting:

Users can output long picture by section cutting which could make cutting more stable and get superior cutting quality. Users can set the section by registration marks or input the value manually. When cutting plotter finishing cutting in section 1, it will continue to cut in section 2. The picture is shown as below:

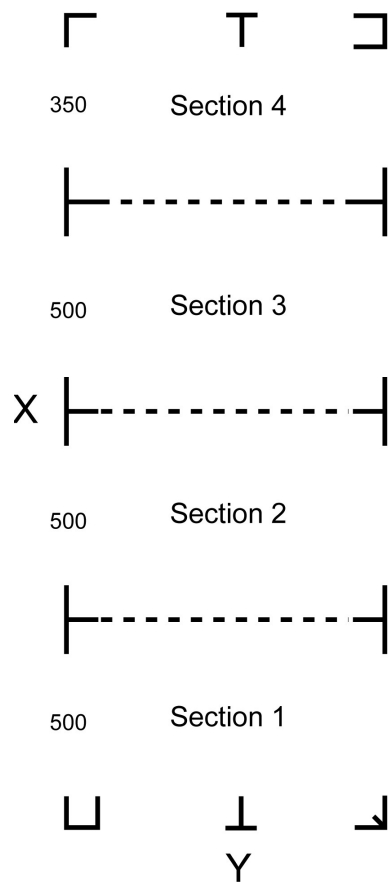

File Function (Option Page):

The file function section allows you to manage various cutter parameters. This section is useful when performing repeated jobs on a variety of objects, allowing you to save your frequently used cutter parameters and load them in the future.

- **Custom Media:** This section lists the files for the parameter settings that you have recently created and worked. You can save more than 50 files to simplify your cutting job.
- **Default:** This section contains the reference settings that are applicable with the verified materials to achieve the best cutting results. Please note that the setting value might need to be adjusted according to different suppliers of materials.
- **SAVE:** This function will save current print driver parameter settings to a file under the specified location on your computer. (Saved parameter setting files will be tagged with the RX II series extension)
- **LOAD:** This function allows you to load previously saved print driver parameters.
- **ORIGINAL:** This function will load the print driver's original factory parameter settings.
- **SAVE TO DEFAULT:** This function allows you to save your current print driver parameters as the default startup settings.
- **DELETE:** This function will delete the file you select from the Custom Media section, whileas the settings in Default section cannot be deleted. Please note the delete function only removes the file from the Custom Media section, it does not remove the .RX file from your hard drive, if you wish to completely remove the file from your hard disk, and you will have to manually delete the file from your operating system.

Note:

If you are using Windows 2000 or XP as your operating system, then make sure you login with an administrator or administrator-rights account in order to properly save cutter parameter settings.

4.7.2 RX II series Print Driver setting > Pen Page

The RX II series incorporates the use of 16 different colors to represent 16 different parameter settings including cutting speed, force and blade offset settings when cutting. These colors are referred to as “Pens”. Think of each pen as a designated cutter setting, rather than as a color. An image that is made up of black, red and blue colors will be processed using the cutter settings designated for each particular color. In order to utilize up to 16 different pens (cutter parameter settings), make sure your graphics software can recognize and utilizes the 16 pen colors designated by the GCC RX II series print driver (please refer to figure 4-21).

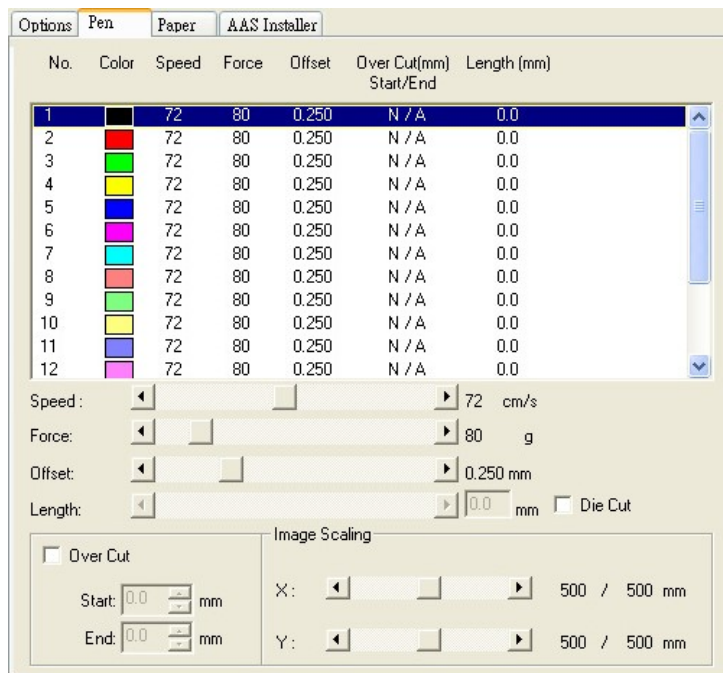

Figure 4-21

If you would like to specify your own colors to designate to a particular cutter setting, then all you have to do is to double-click on that particular pen color from the pen menu and a color manager window will open where you can select “define custom colors” to define your own color (shown in the picture below). This is useful when your image is composed of colors that are not part of the pen menu’s default color selection, and instead of modifying your image, you simply would like to assign the cutter settings based on the existing colors from your current image.

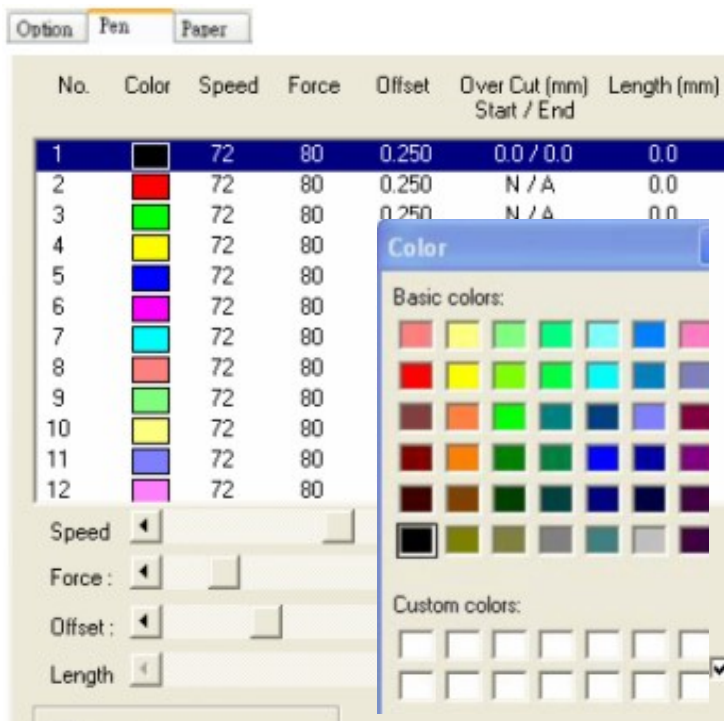

Figure 4-22

Note:

The GCC RX II series driver cannot store more than 16 pen colors or different cutter parameter settings per file.

Speed (Pen Page) [DEFAULT SETTING: 72cm/sec]

The speed slider controls the cutter's cutting speed during operation with a range setting from 3 – 153cm/sec. The GCC RX II series maximum cutting speed is 153 cm (60 inches) per second.

Force (Pen Page) [DEFAULT SETTING: 80g]

The force slider controls the cutting force during operation with a range setting from 0 – 600g.

Offset (Pen Page) [DEFAULT SETTING: 0.25mm]

The offset slider controls the blade offset depending on the blade you used.

Die Cut (Pen Page)

The Die Cut function can allow you to cut through the backing of the material. You can only use the first 8 pen for this function. If you choose Pen No.1 and click the Die Cut function, the Pen No.9 will become Pen No.1* for setting different parameter for the same cutting line. (Figure 4-24)

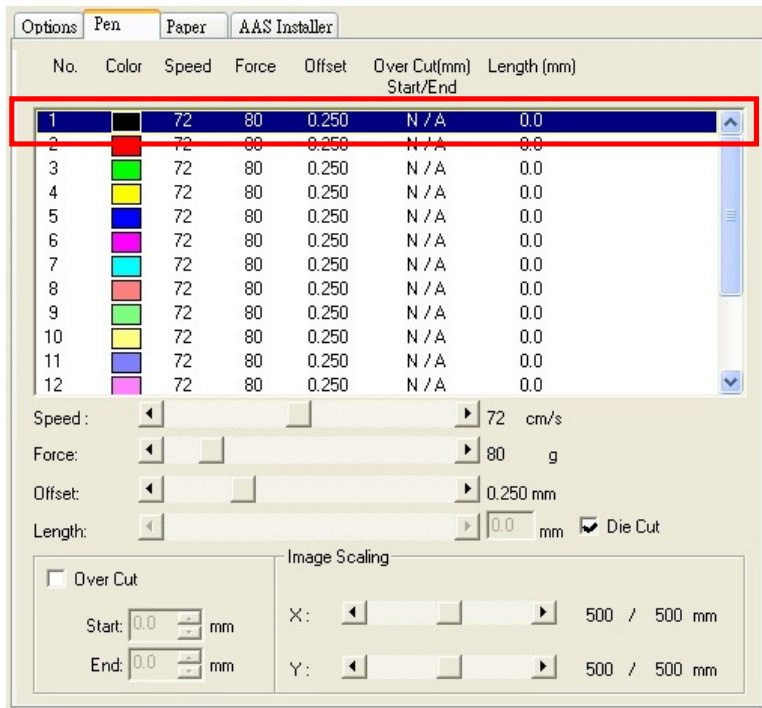

Figure 4-23

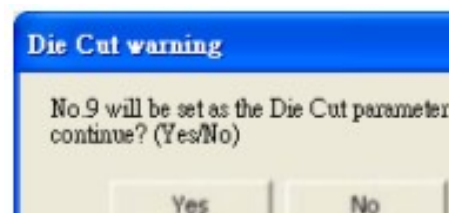

Figure 4-24

You can adjust the parameter such as force and length in both Pen No.1 and Pen No. 1* as you need. For example:

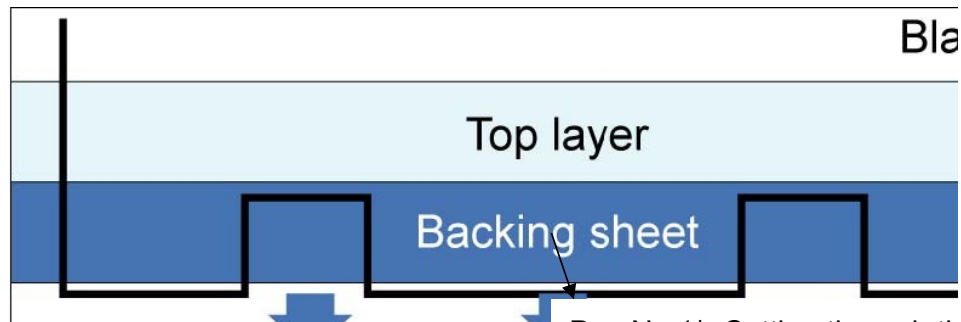

Figure 4-25

Pen No.1*: Cutting through the backing of the material
 Pen No.1: Cutting through the vinyl only

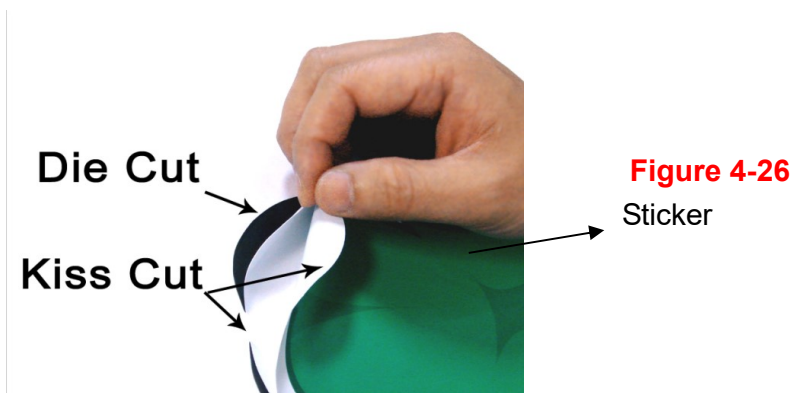
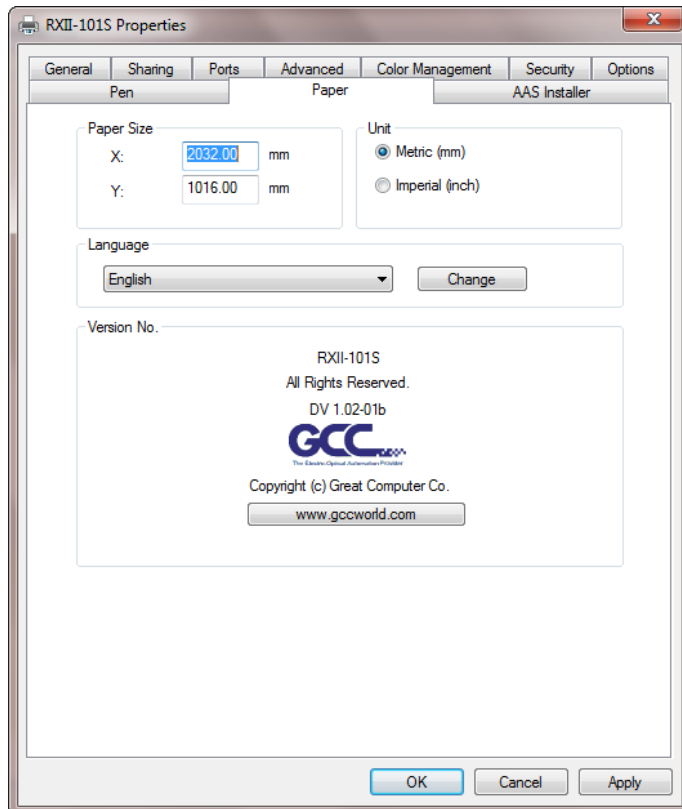

Figure 4-26

Image Scaling (Pen Page)

The Image Scaling function can allow you to set the image scale of media length and width to decrease the difference between the actual length and the ideal length caused by various media used while processing cutting job.

4.7.3 RX II series Print Driver setting > Paper Page



Paper Size (Paper Page) [DEFAULT SETTING: Y = the width of machine; X will be automatically set to be twice the length of Y]

The paper size represents your total work area. The X value represents the length and the Y value represents the width. The paper size should be set as the same as your image so you can get a better cutting quality.

Unit (Paper Page) [DEFAULT SETTING: Metric (mm)]

Here you can set your preferred measurement standard in which you would like use with the RX II series print driver. You can choose between metric or imperial standards.

4.8 How to set die/kiss cut through plug-in software for Adobe Illustrator and CorelDraw

Die/kiss cut function allows you to define two cutting parameter in one cutting line, you can set through plug-in software for Adobe Illustrator and CorelDraw directly instead driver setting by designate the line to green color RGB 255 and then set the length and force from the control panel.

1. Select an outline that you want to do die/kiss cut in working area.

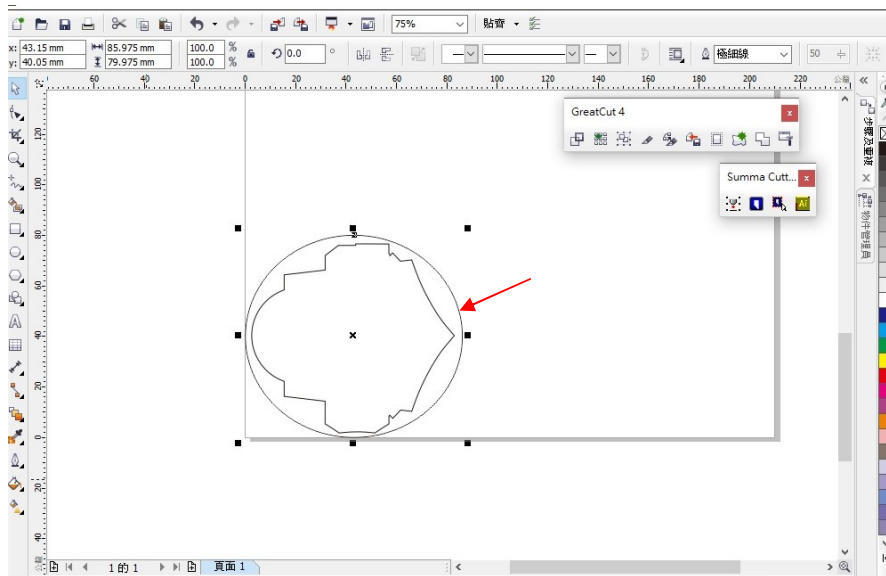

Figure 4-27

2. Change the color to **green color code RGB 255** then click “OK”
(Note: Only green color code RGB 255 is identified as die/kiss cut function, please don't select other color otherwise the function cannot work)

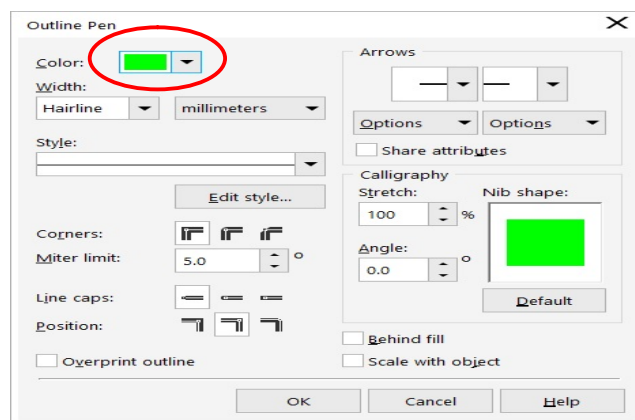

Figure 4-28

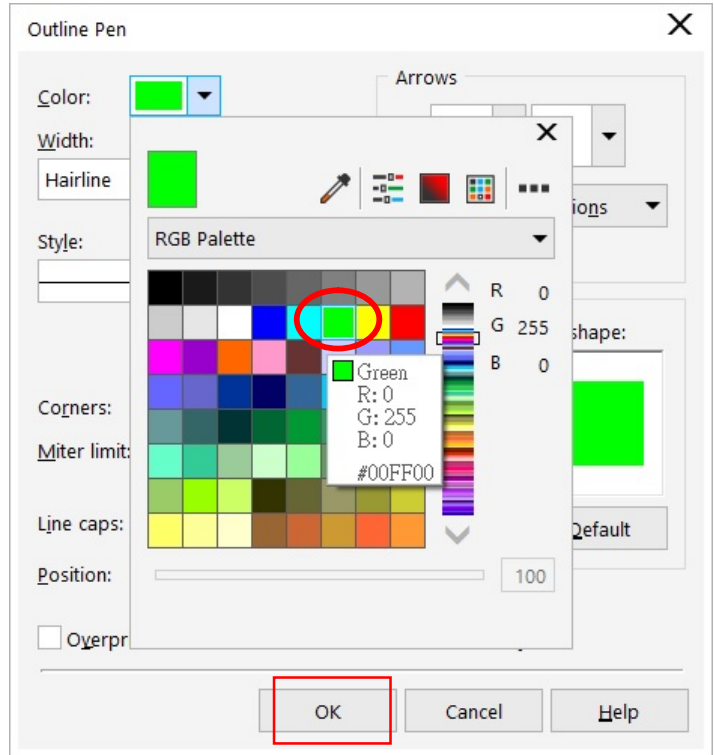

Figure 4-29

3. Outline color has been changed to Green.

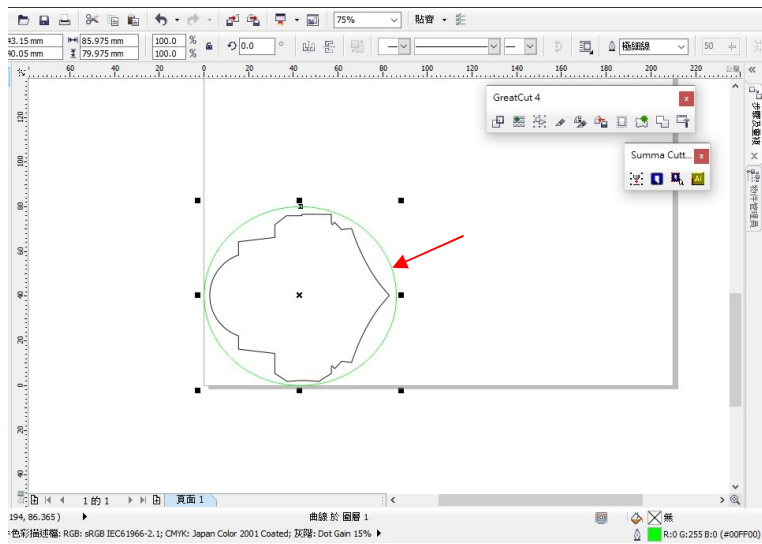
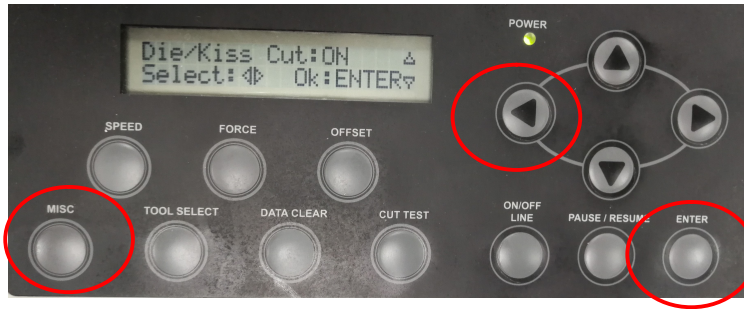
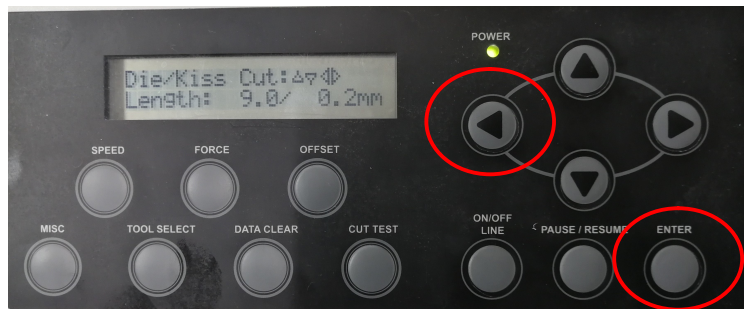

Figure 4-30

4. Select "On/Off Line" > "MISC", use arrow key to select "Die/Kiss Cut" function then press "Enter".



5. Click the left arrow key to the next page to adjust the length value (0.2mm ~ 9.0mm) then click "ENTER".



6. Click the left arrow key to the next page to adjust the force value (45g ~ 450g) then click "ENTER" and finish the setting.

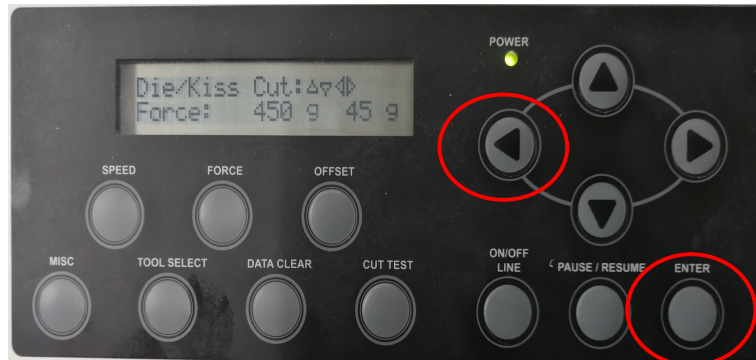

4.9 How to create a file for cutting with barcode function

The barcode function allows the association of barcode graphics with cutting files. By adding barcode graphics to the cutting file, the plotter can automatically perform cuts based on the information encoded in the barcode. This is particularly useful for batch cutting or cutting tasks with specific requirements, as it provides higher efficiency and accuracy

1. Import the image you want to cut.

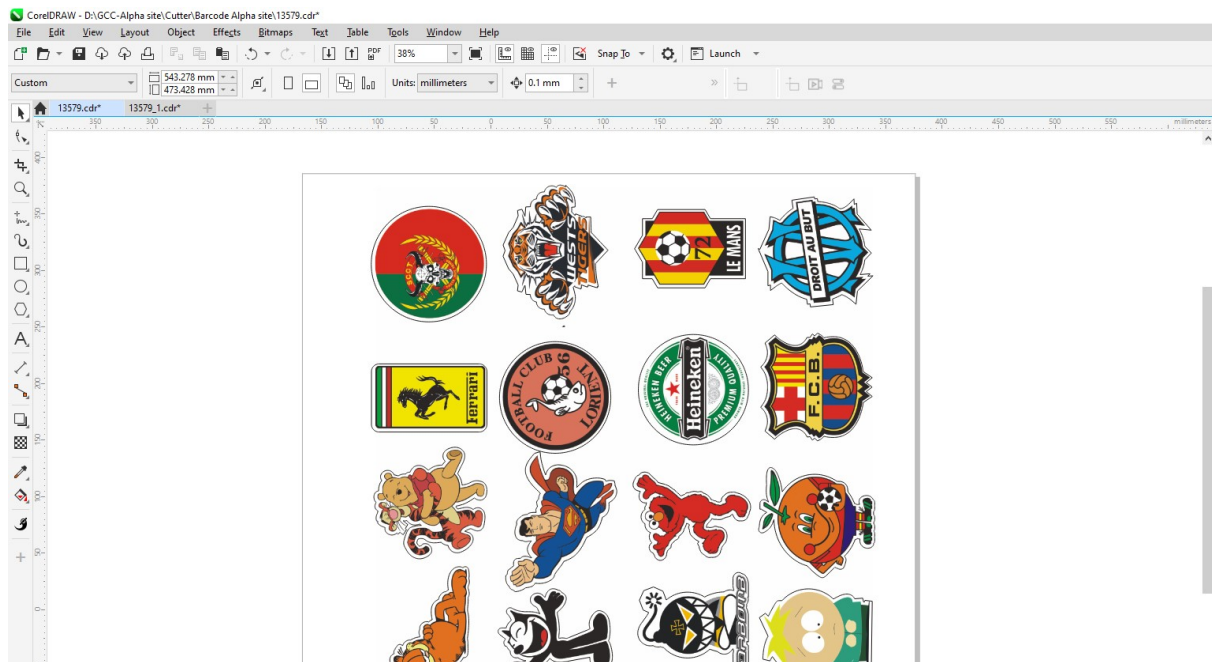

2. Go to Tools -> Scripts -> Run Script...

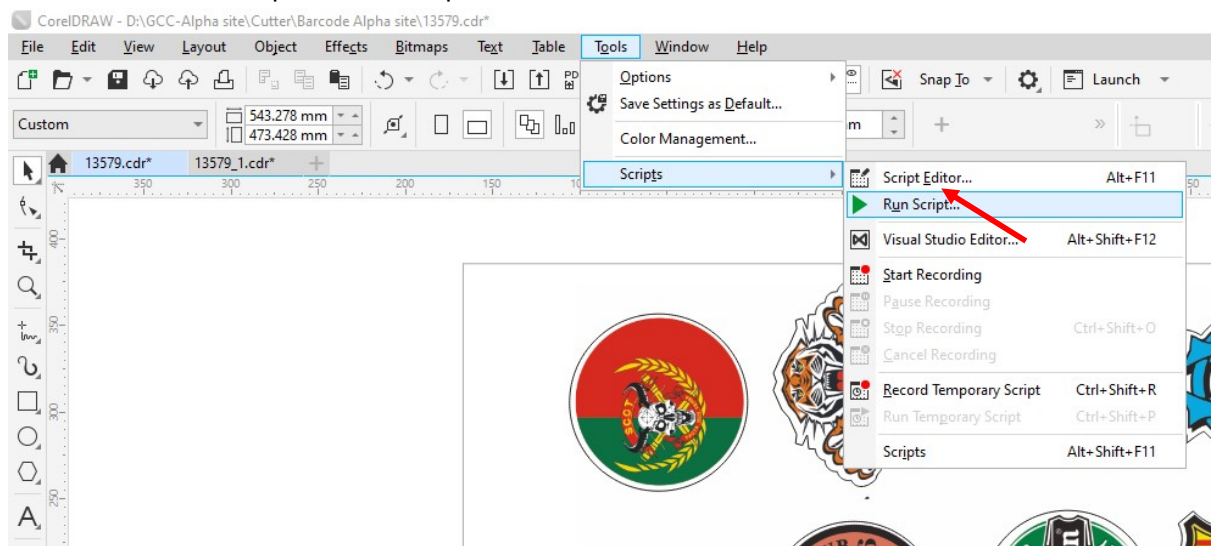

3. Select "GlobalMacros (GCCAASII_Draw.gms)" and select Run.

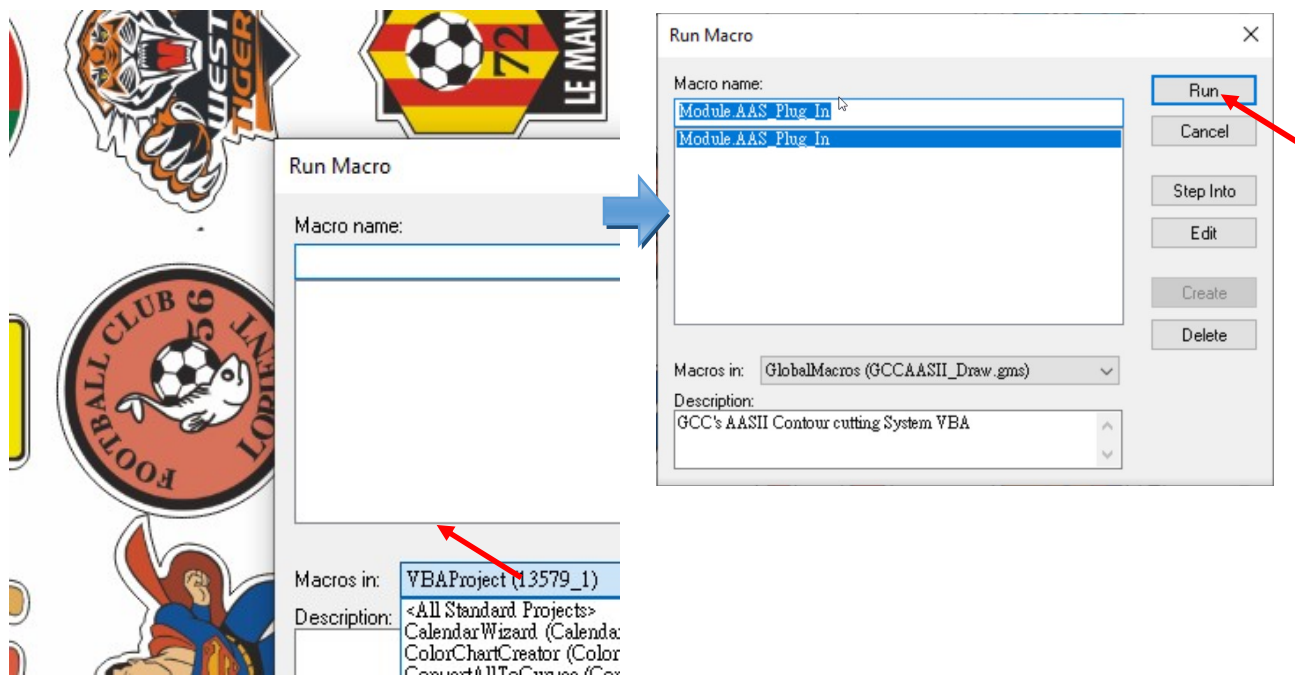

4. The "AASII Reg. Mark Setting" window will pop-up. Tick the Check box and click Apply.

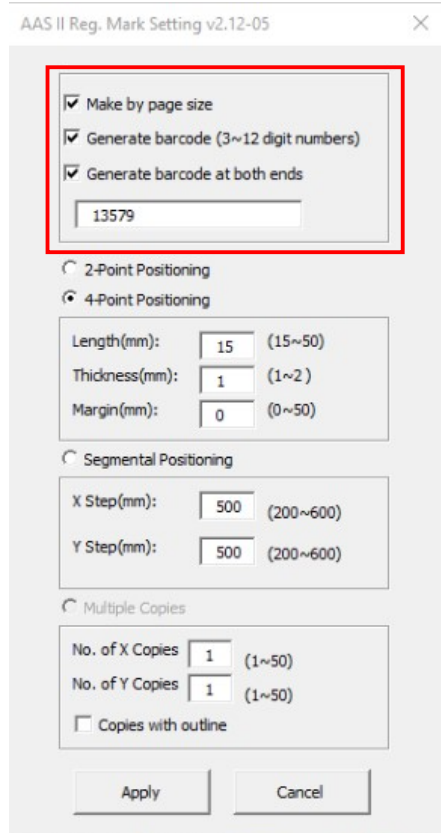

Note:

Make by page size: to generate barcode by page.

Generate barcode (3~12 digit numbers): a barcode will be generated associated with the numbers being entered. Please note that the barcode number must be the same as the name of the cutting file.

Generate barcode at both ends: to generate barcodes at both ends of the image.

5. The barcode will be generated.

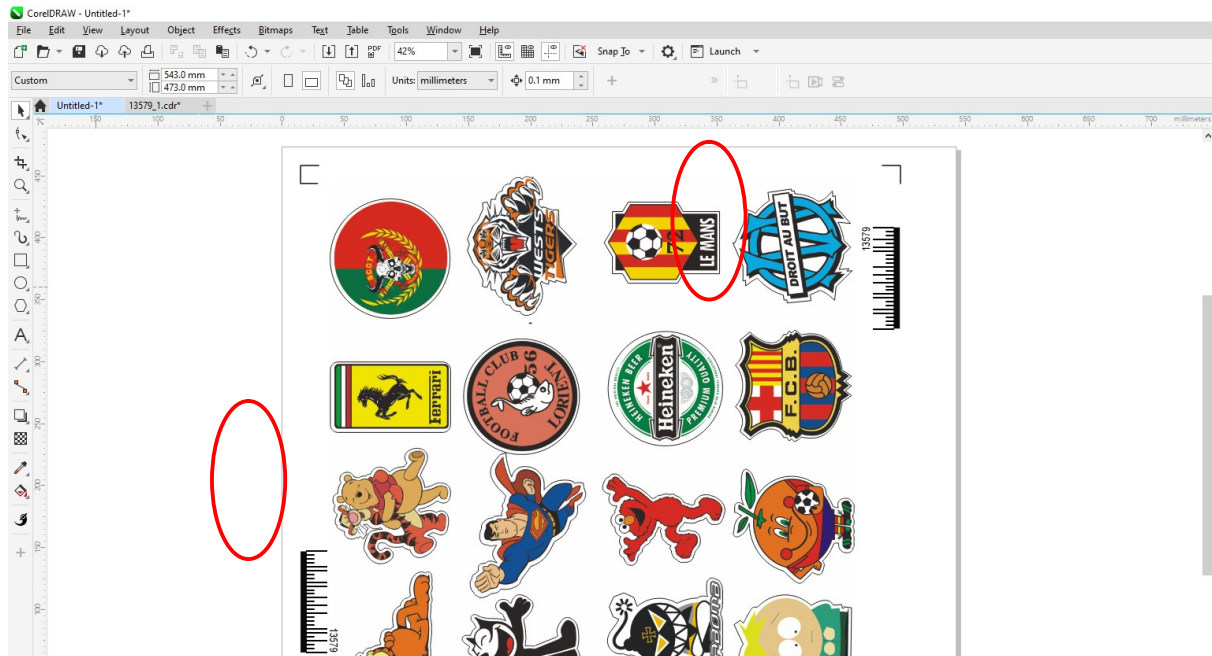

6. Go to “Save As...” option in the File menu and choose the preferred file format for printing. Print the file using your printer to prepare it for later cutting.

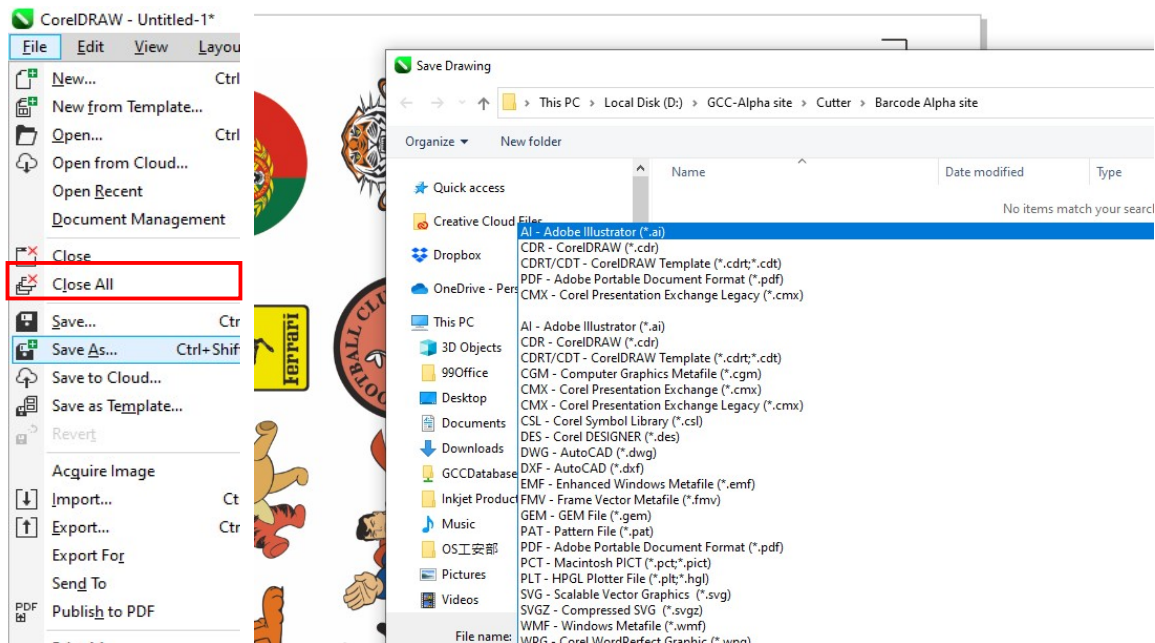

- Go to “Print...” option in the File menu or click “Print” to open the Print window to save the cutting file for cutting with barcode function.

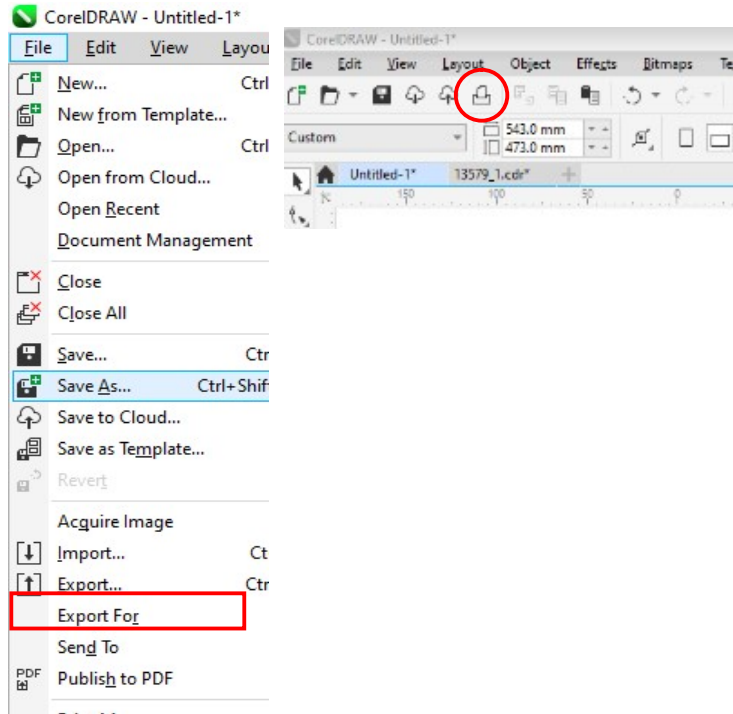

- Navigate to “Layout” tab to set the Reposition artwork to Bottom left corner.

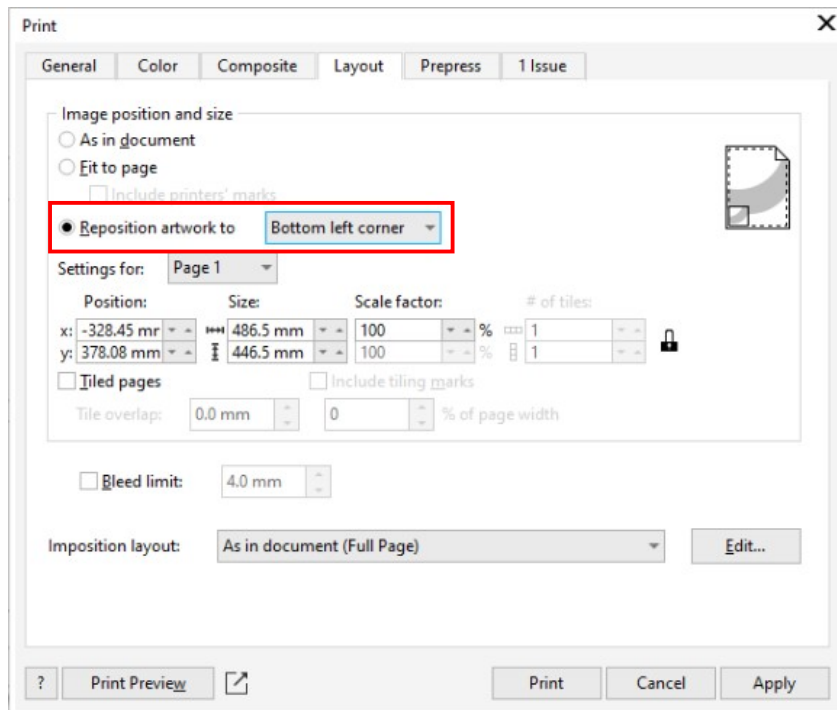

9. Go to “General” tab and check the “Print to file” option, then click Print.

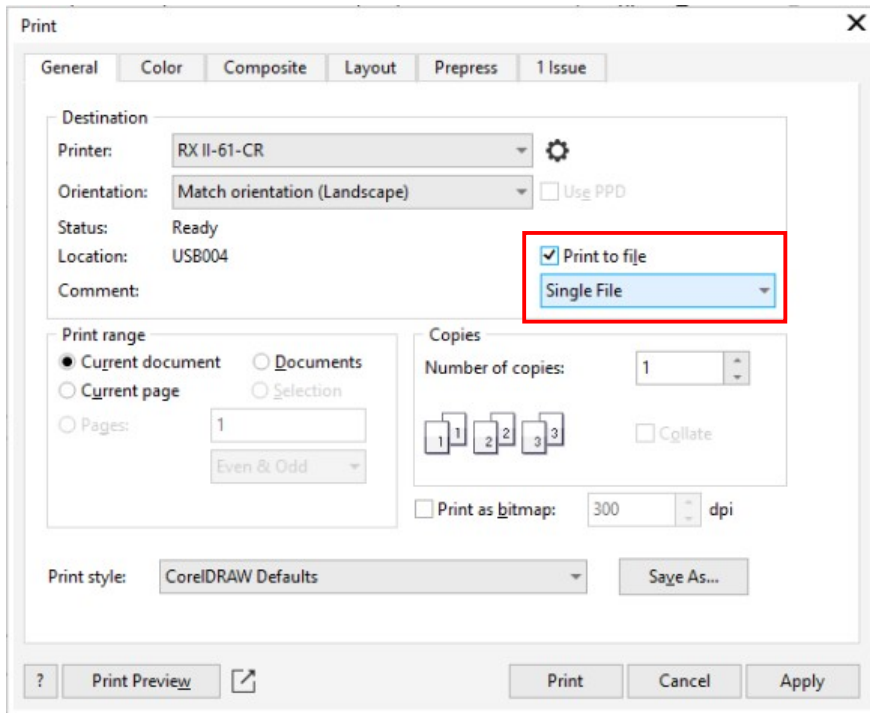

Note: make sure the file name is the same as the number of the barcode in step 4.

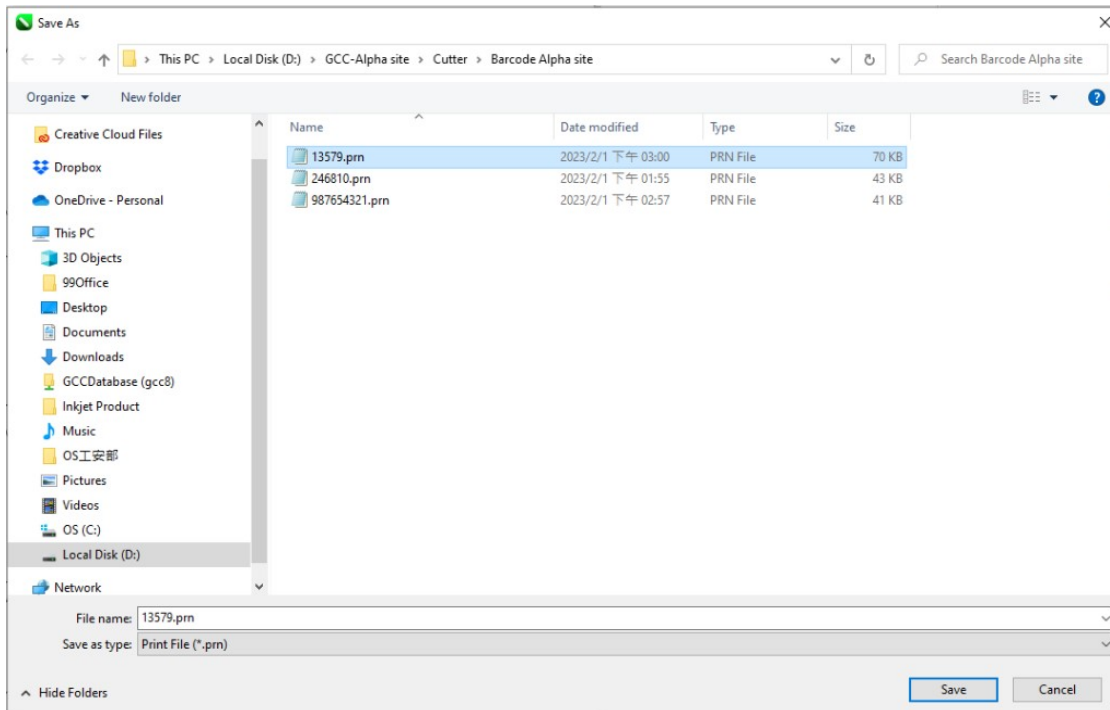

10. Open SmartCUT. Designate the folder location to set the directory and click OK.

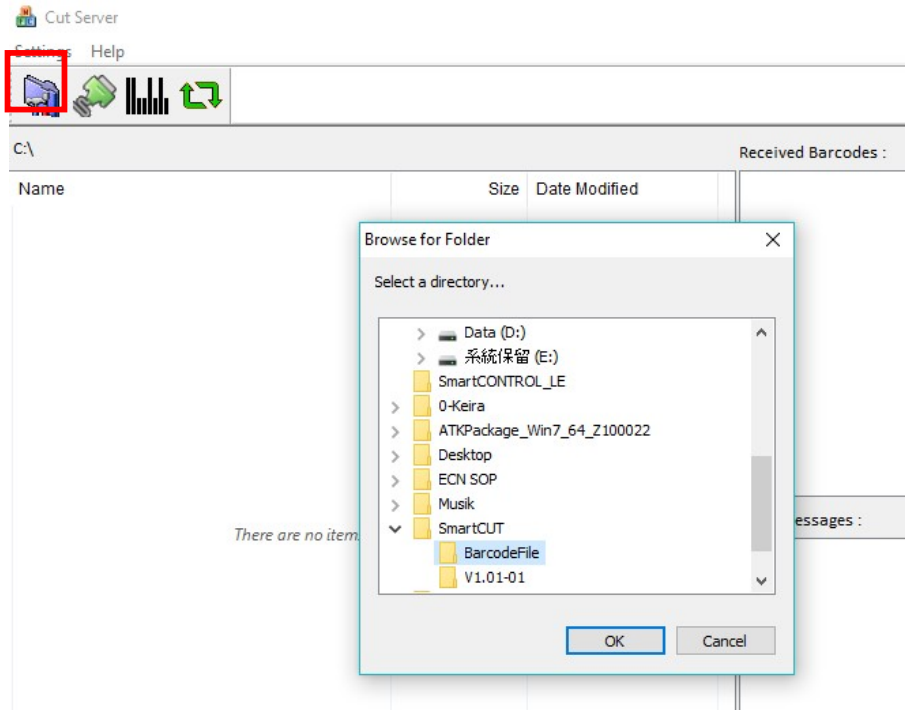

All files being saved for cut with barcode function in this hot folder will be displayed.

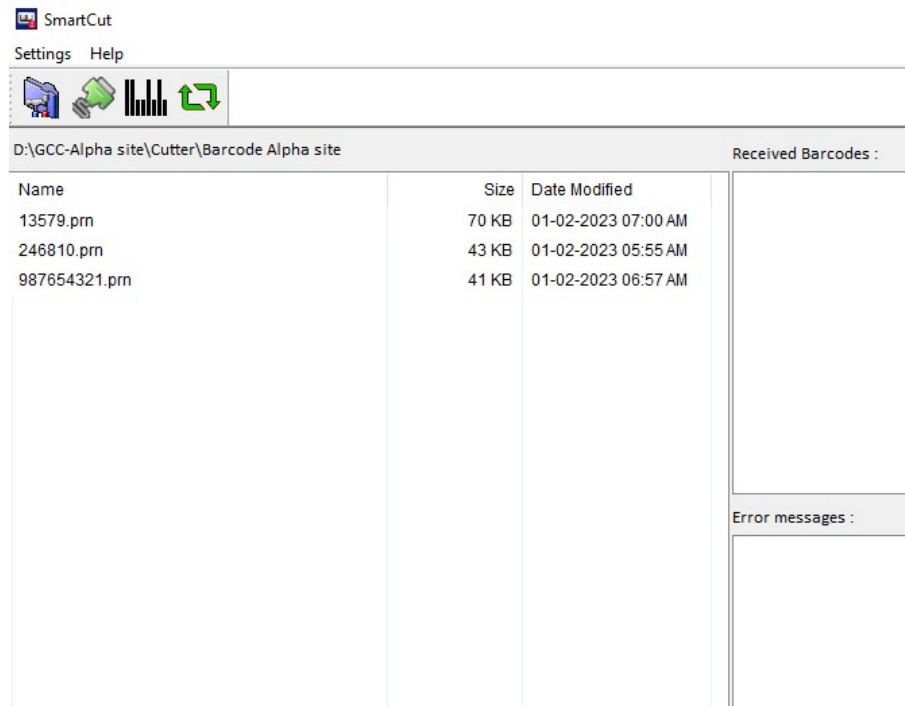

11. Set the communication port and click OK.

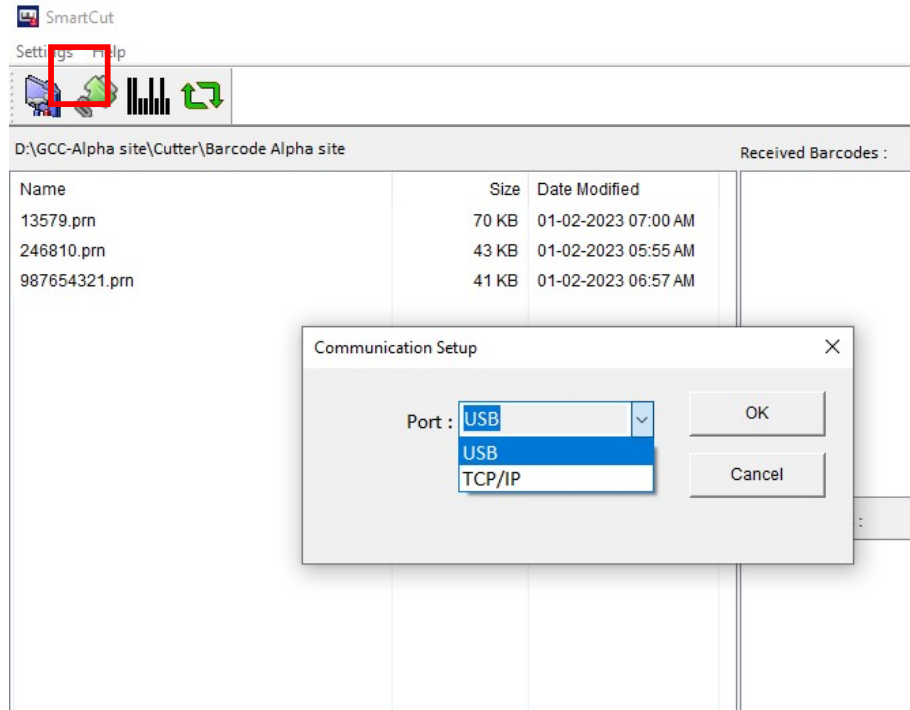

12. Load the printed media. Click on Scan icon to start barcode detecting and cutting.

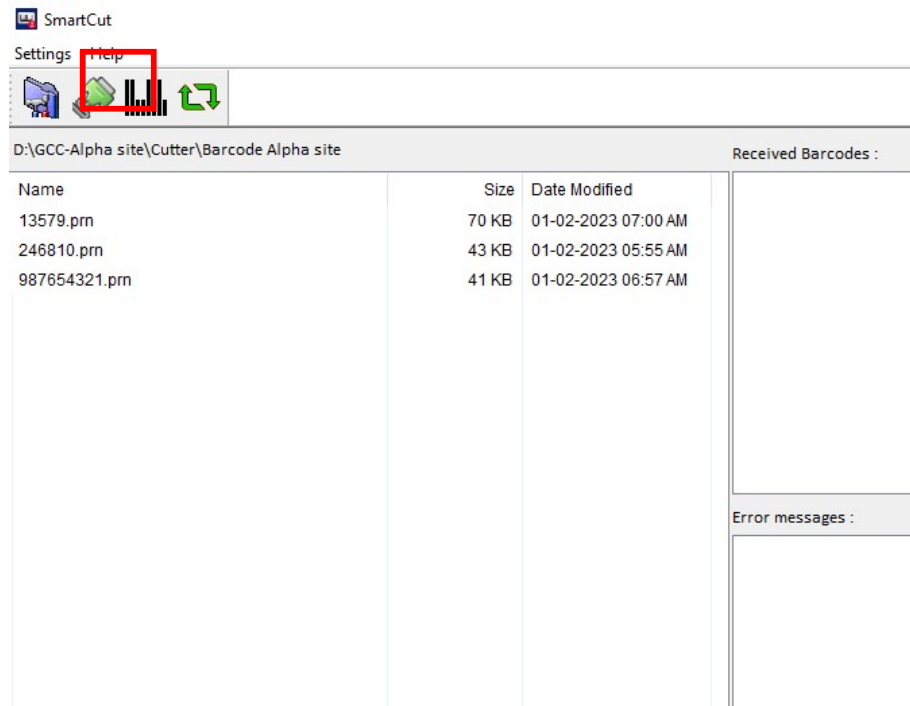

Note:

If you add a new file to the hot folder, click the 'Refresh' button, and the newly added file will be displayed."

If there are any errors, the details will be shown in the Error Messages box

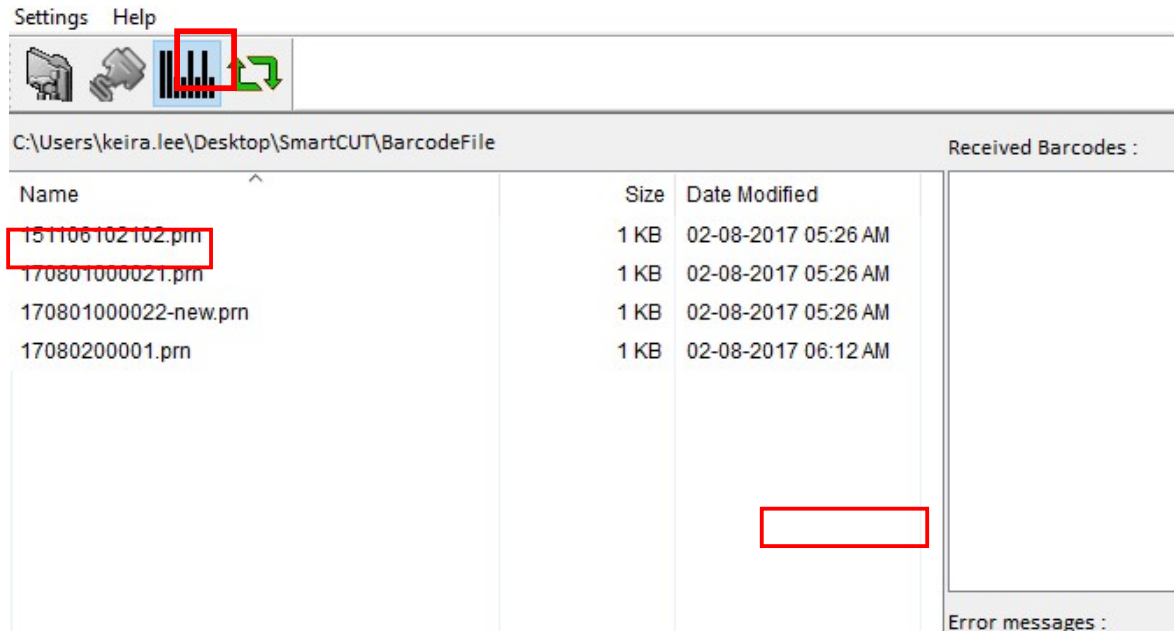

Note:

If the machine does not respond, reboot the machine to restore the operation.

4.10 Reference Parameter setting for different materials

The following reference parameter is used on GCC verified materials shown in the table.

Material	Personalized/ Wall stickers	Vehicle stickers	Window decoration	Window tint
Blade	red	red	red	red / yellow
Blade tip length (mm)	0.28	0.27	0.25	0.09
Force (g)	105	85	95	70
Speed (cm/sec)	72	60	65	72
Offset (mm)	0.25	0.25	0.25	0.25
Recommend model	RX, Jaguar, Puma, EX, AR	RX, Jaguar, Puma, EX, AR	RX, Jaguar, Puma, EX, AR	RX, Jaguar, Puma, EX, AR
Material	Stencil	Reflective film	Flock	Cardboard
Blade	red / green	green	green	green
Blade tip length (mm)	0.3	0.5	0.3	0.3
Force (g)	180	380	135	165
Speed (cm/sec)	15	3	30	30
Offset (mm)	0.25 / 0.5	0.5	0.5	0.5
Recommend model	RX, Jaguar, Puma, EX, AR	RX, Jaguar, Puma, EX	RX, Jaguar, Puma, EX, AR	RX, Jaguar, Puma, EX, AR
Material	Magnets	Protective tint	Rhinestone	Sandblast mask
Blade	green	green	green	blue
Blade tip length (mm)	0.8	0.3	0.8	0.27
Force (g)	580	320	190	85
Speed (cm/sec)	3	3	15	60
Offset (mm)	0.5	0.5	0.5	0.25
Recommend model	RX, Jaguar	RX, Jaguar, Puma, EX	RX, Jaguar, Puma	RX, Jaguar, Puma, EX, AR
Material	Small text (vinyl)			
Blade	black			
Blade tip length (mm)	0.27			
Force (g)	thick: 150 thin: 90			
Speed (cm/sec)	9			
Offset (mm)	0.175			
Recommend model	RX, Jaguar, Puma			

Chapter 5 Automatic-Aligning System

Please note that this chapter is only an instruction to AASII; for step-by-step instructions, please refer to the following chapters: 08_A-3 CorelDraw Plug-In, 08_A-4 Illustrator Plug-In, 08_A-5 GreatCut Plug-In.

5.1 Introduction

The RX II series cutting plotters feature a standard Automatic-Aligning System (AAS II) to guarantee precise contour cutting quality by detecting the registration marks printed around the graphic.

Notice

- Avoid any kind of light source horizontally illuminating the AAS module.

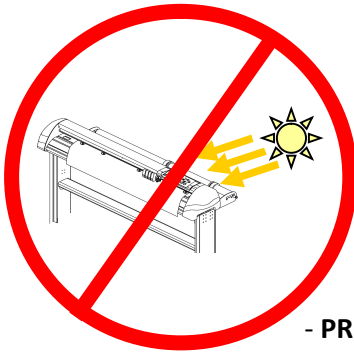

- PROHIBITED

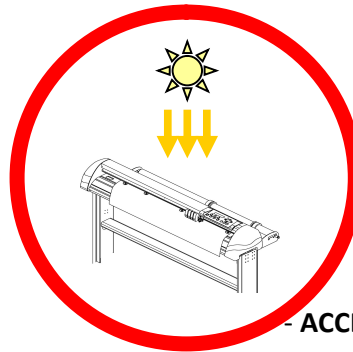

- ACCEPTABLE

- DO NOT take off the cover of AAS module while in operation.



- PROHIBITED

5.2 AAS Contour Cutting System

The AAS system has one calibration procedure to ensure maximum accuracy of AAS operation. To operate the AAS you need to learn about the method of media feeding firstly. (Refer to 4.1 Media Loading.)

5.2.1 Notice for Registration Marks

The first registration mark is designed to be different in order to identify the origin for AAS auto-detection. The following precaution must be aware for registration marks to be read automatically.

- Type of media
- Registration mark pattern
- Reading range required for detection the registration marks
- Position for registration marks and medium

The registration marks have to be:

- Created by cutting software like GreatCut or GCC CorelDRAW plug-in
- In black color (printing quality of registration marks is essential; incorrect, misaligned colors, blurry or smeared printout might leading to inaccurate cutting result)
- Length: The length of marks
 - Range: 5mm~50mm
 - Optimized Setting: 25mm
- Thickness: The line thickness of marks
 - Range: 1mm~2mm
 - Optimized Setting: 1mm
- Margin: The distance between marks and images
 - Range: 0mm~50mm
 - Optimized Setting: 5mm

The cutter can not detect the marks while:

- Cutter carriage is not located near the outside area of first mark before detecting (See the picture in page 5-7 for auto-detecting area of first mark.)
- Medium thickness is more than 0.8mm
- Transparent medium is used
- Non-monochrome drawing. The marks can't be read if is printed on colored medium
- Dirty or creased medium surface

5.2.2 AAS II on RX II series

There are three types of AAS II mark patterns: 4-Point Positioning, Segmental Positioning, and Multiple Copies. Note that before print out your designs by inkjet printers, the registration marks have to be created on your graphic designs by cutting software like GreatCut, SignPal or GCC CorelDraw plug-in. Hand-made marks or drawings won't be reorganized by GCC cutting plotters. For more details about registration mark setting in cutting software, please refer to appendices for detailed instruction.

1. 4-Point Positioning

This is the basic mark pattern that AAS II will auto detect four registration marks and contour cut images inside those marks.

- Command: Esc.D1;(XDist);(YDist):
- Layout: 4 registration marks at the 4 corners around the design

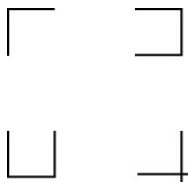

2. Segmental Positioning

In addition to 4 original points, the intermediate registration marks are added on both X axis and Y axis to help contour cut accurately, especially for cutting large images.

- **Command:** Esc.D2;(XDist);(YDist);(XStep);(YStep):
- **Layout:**
 In-between distance on X: 200~600mm, default 300mm
 In-between distance on Y: 200-600mm, default 300mm

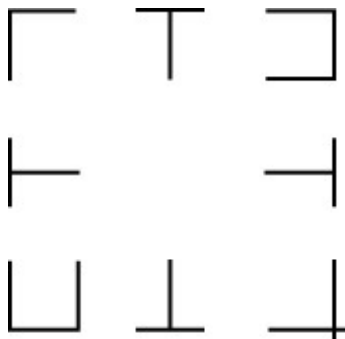

■ **High Precision Long Picture Cutting**

RX II series performs section cutting to enhance output qualities.

- The object will be output following the section pattern based on the Segmental Positioning parameters.
- Cutting sequence: Section1-> Section 2-> Section 3-> Section 4

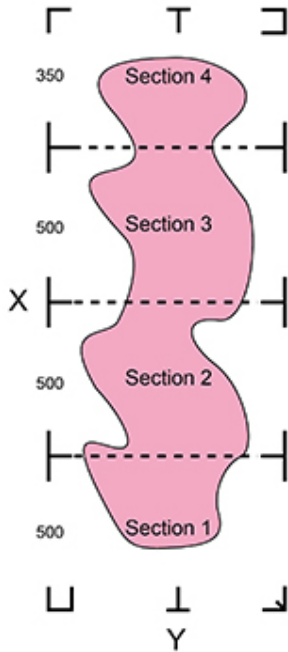

3. **Multiple Copies**

The function is used to duplicate images to let you cut quantities of images at a time. The AAS II sensor will automatically scan registration marks for each individual image to ensure the contour cutting precision.

- **Command:** Esc.D3;(XCopies);(YCopies);(Space):
- **Layout:**

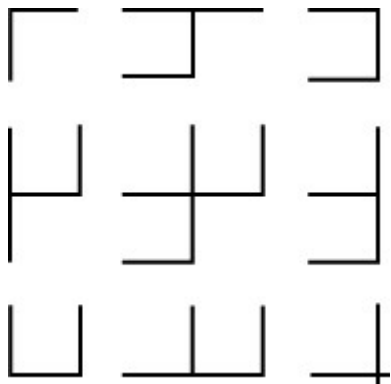

5.2.3 5.2.3 Automatic Distinction of the Plot Direction

For the convenience of users, RX II series automatically detects the feeding direction of the material when performing contour cutting. Figure 5-1 shows the Registration Mark detection sequence when the material is fed in the standard way (1->2->3->4) while Figure 5-2 is how RX II series detects registration marks (3->4->1->2) when the material is reversely fed. RX II series is able to detect registration marks and performs contour cutting however users feed the media.

Direction detection steps:

(Please see Figure 5-2)

- a. Detects the position of the 3rd Registration Mark
- b. Proceeds to the 4th Registration Mark to detect the direction
(The direction detection procedure will be performed by the detection of 4th Registration Mark)
- c. The information is reflected in the driver and recalculated before output
- d. The registration mark detection and object output process is implemented

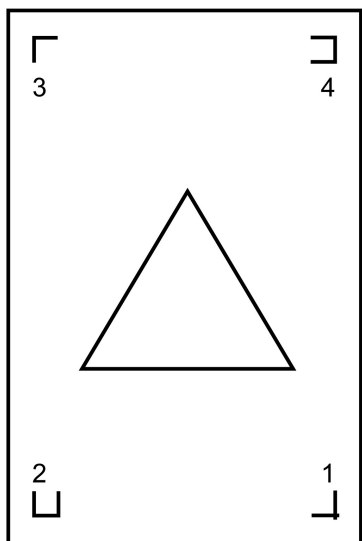

Standard Media Feeding Direction 1->2->3->4

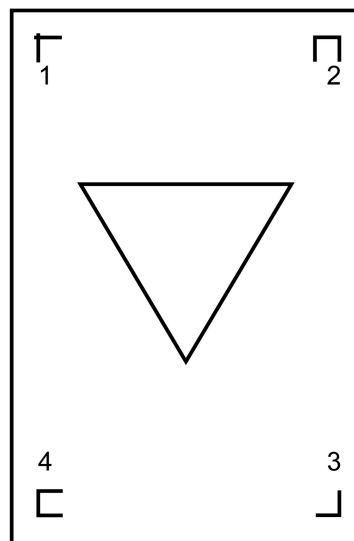

Reversed Media Feeding Direction 3->4->1->2

(Registration Mark detection sequence: 3->4->1->2)

Figure 5-1

Figure 5-2

5.3 Printer Test

Before performing AAS contour cutting, it's recommended to print out a test file to make sure the AAS II cutting accuracy. Please visit GCC website and go to Download Area to download the test files.

<https://www.gccworld.com/download.php?act=view&id=20>

Title	Size	Download
Cutter AAS Offset Test Files	3.0MB	Download
Cutter Clipart Library (AE file)	1107KB	Download

There are two testing files for AASII:

1. AAS II_X_Y_Offset_Caberation_A4 .eps (A4 size)
2. AAS II_X_Y_Offset_Caberation_600_600 .eps (Default setting, it is recommended for testing)

- Print out the testing graphic. (Please use high precision printer)
- Load the graphic to RX II series and sent the file to test the cutting job
- If there are any adjustments to be made, you can change the offset value by following the steps:
 - Measure the offset values from the printed line and the actual cutting line.
 - Enter the AAS Offset under MISC function for the values you just measured, then press Enter
 - Test the cutting again
 - AAS II offset X and Y value is defined as following:
Horizontal line is defined as X and vertical is defined as Y (when facing the cutting plotter)

- When the actual cutting line and the printed line need to be changed towards the direction of origin mark, then simply add the negative value of the offset. If the direction is from the opposite of the origin mark, then enter positive values for the offset (see the following figures). This method applies to both X and Y axes.

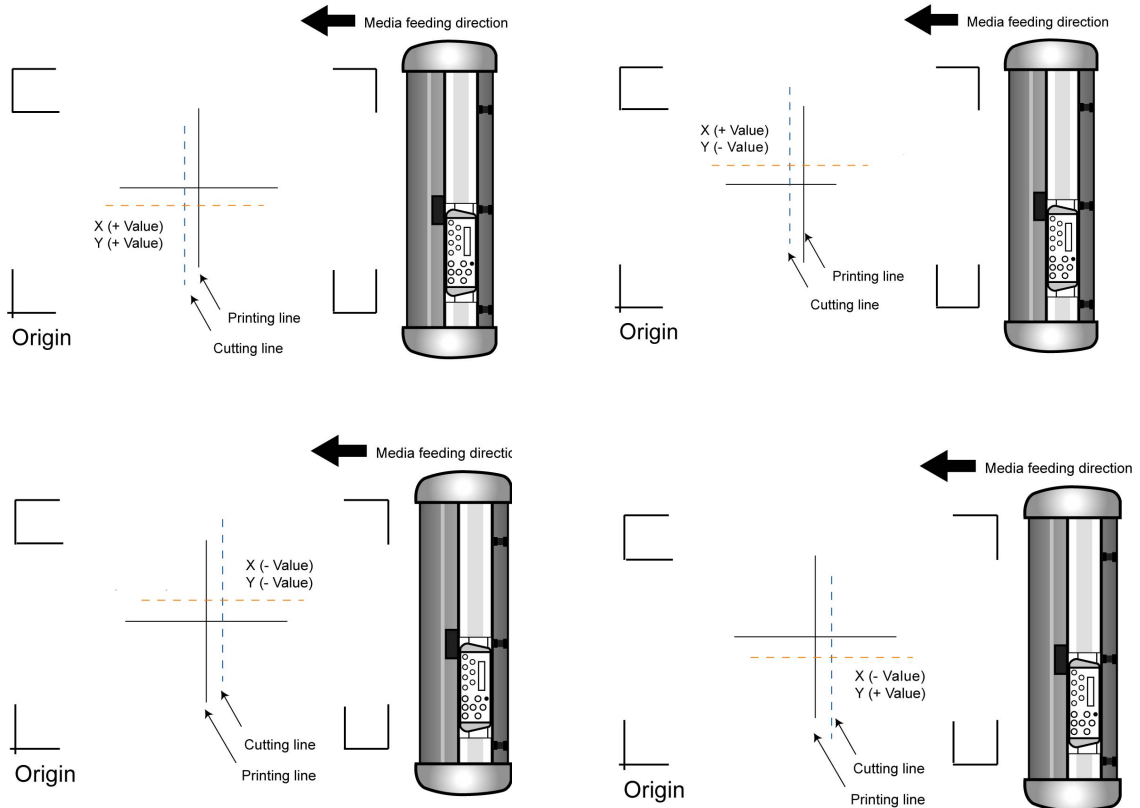

Note:

- Before adjusting the AAS II settings, please proceed scaling for width and length.
- The blade offset value isn't set for this test graphic, please set it according to the blade you use.
- If you have any question, please contact us or your local distributor for assistance.

5.4 Registration Mark Offset Range

Please correctly load your media (refer to the alignment ruler on the platen) to make sure the registration marks are successfully detected. Deviation exceeds the range below will lead to detection failure.

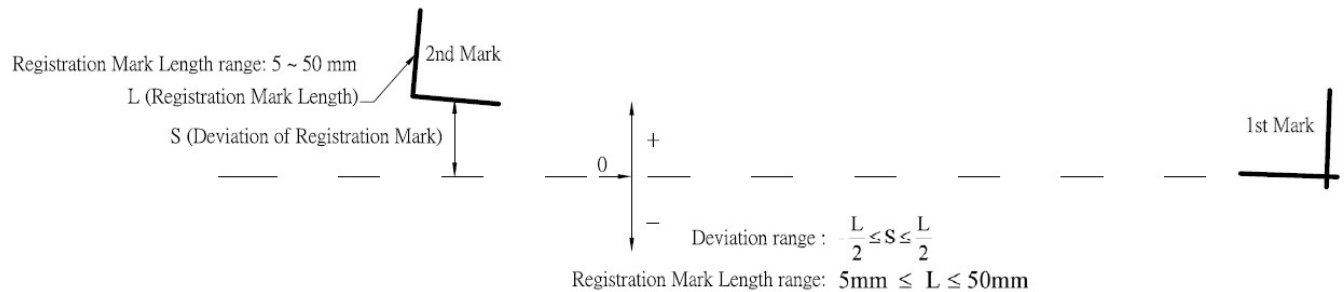

5.5 Contour Cutting

For accurate contour cutting with AAS function, please proceed the following steps:

Step 1 Creating Graphics

- Create the graphic that you want to print and cut in your software.



- Create a contour for cutting around the graphic.



TIPS1: Leave some space between the graphic and contour line.

TIPS2: Create the contour in a separate layer and assign a different color for it.

- Add registration marks around the graphic.

Note:

The Multiple Copies function is also available. It automatically copy the graphic and registration marks.

Step 2 Placing the Registration Marks

- The AAS Layout Instruction:

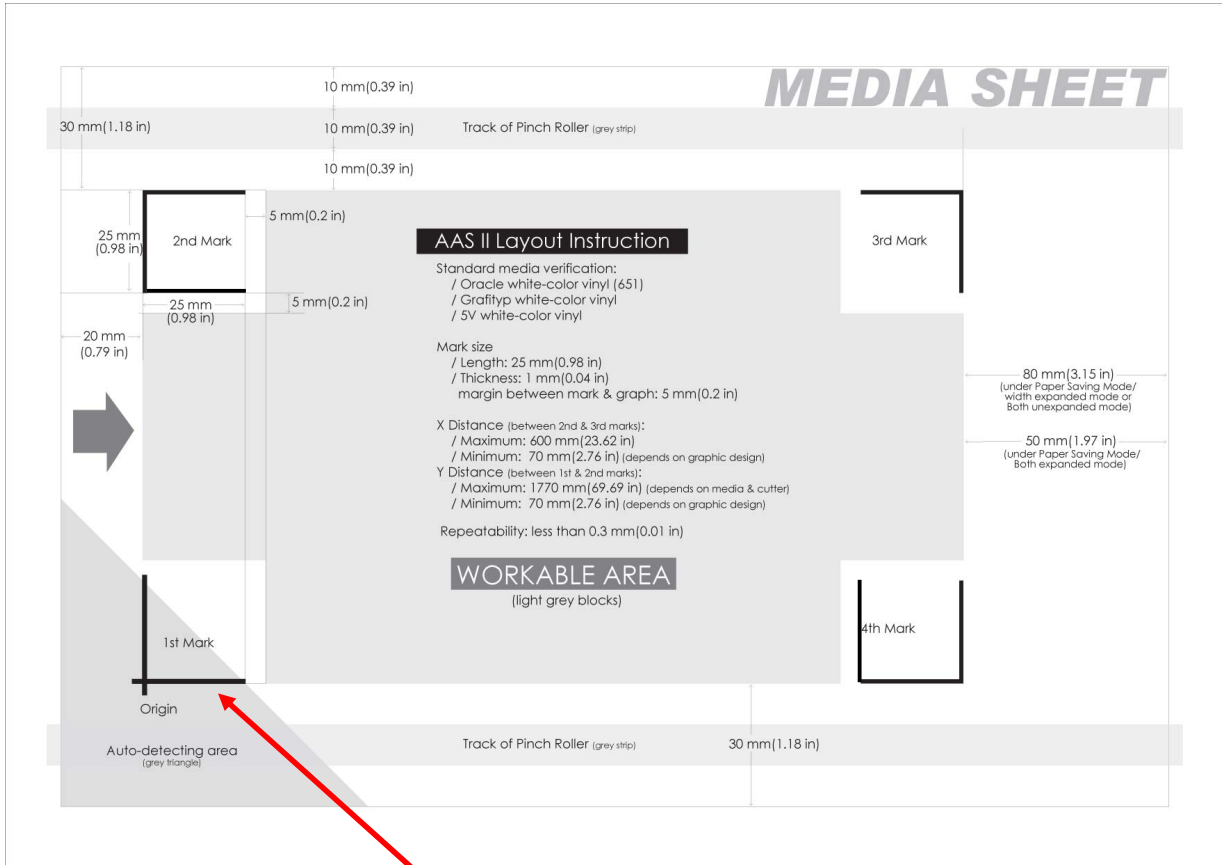

* Auto-detection function on the 1st mark covers the grey area

- Suggested 30mm margin on both left and right sides of media sheet.
- Suggested 20~30mm margin on top of media sheet, and at least 50mm margin on the bottom edge to prevent sheets dropping or any error occurred while media sizing.

Step 3 Print the Graphics

- Print the graphic and the marks with your printer

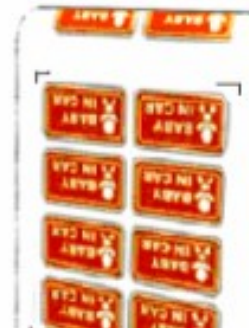

(Scaling = 100%).

- When printing on a roll media, make sure the orientation as following:

Step 4 Load the printout onto cutter

■ The Origin Mark is different from the rest registration marks. Please make sure the media is fed with correct direction.

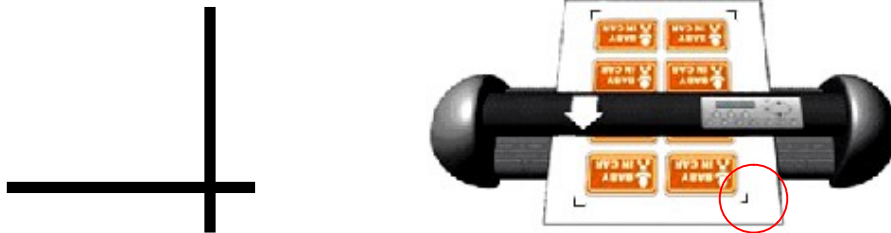
**Step 5** Cut the Contour

■ Send out the command from software to perform the contour cutting job.

5.6 Tips for AAS

For getting better results of contour cutting, there are some tips below for your reference.

- Keep light sources simple and avoid illuminating from the sides of cutter.
- Before operating AAS, change the maximum paper size in RX II series driver property.

Step 1 Find the **RX II model** in the “Printer & Fax” folder of your PC.

Step 2 Open the Properties window and select the “Paper” tab.

Step 3 Change the maximum Paper Size of X to **1200mm**.

- Adjust the cutting speed to between 300~600mm/sec.
- Avoid the registration marks locating on the tracks of pinch rollers.
- Make sure the edge of the media is not bent up when detecting registration marks.

Chapter 6 Maintenance

This chapter explains the basic maintenance (i.e. cleaning the cutting plotter) required for the cutting plotter. Except for the procedures mentioned below, all other maintenance must be performed by a qualified service technician.

6.1 Cleaning the Cutting Plotter

Cleaning the machine properly and regularly will ensure optimal performance out of your machine.

Cleaning Precaution!



- Unplug the cutting plotter before cleaning it in order to prevent electrical shock.
- Never use solvents, abrasive cleaners or strong detergents for cleaning. They may damage the surface of the cutting plotter and the moving parts.

Recommended Methods:

- Gently wipe the cutting plotter surface with a lint-free cloth. If necessary, with a damp cloth immersed in water or alcohol. Dry and wipe any remaining residue off a soft, lint-free cloth.
- Wipe all dust and dirt from the tool carriage rails.
- Use a vacuum cleaner to empty any accumulated dirt and media residue beneath the pinch roller housing.
- Clean the platen, paper sensors and pinch rollers with a damp cloth immersed in water or alcohol, and dry with a soft, lint-free cloth.
- Wipe dust and dirt from the stand.

6.2 Cleaning the Grid Drum

1. Turn off the cutting plotter, and move the tool carriage away from the area needed to be cleaned.
2. Raise the pinch rollers and move them away from the grid drum for cleaning.
3. Use a bristle brush (a toothbrush is acceptable) to remove dust from the drum surface. Rotate the drum manually while cleaning. Refer to Figure 6-1.

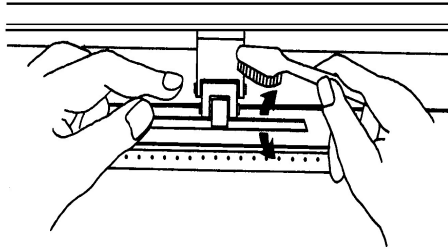

Figure 6-1

6.3 Cleaning the Pinch Rollers

1. If the pinch rollers require a thorough cleaning, use a lint-free cloth or cotton swab to wipe away the accumulated dust from the rubber portion of the pinch rollers. To prevent the pinch rollers from rotating while cleaning, use your finger to hold the pinch rollers to prevent them from rotation
2. To remove the deeply-embedded or persistent dust, use the lint-free cloth or cotton swab moistened with rubbing alcohol.

Note: The daily maintenance of your cutting plotter is very important. Be sure to clean up the grid drum and pinch rollers regularly for better cutting accuracy and output quality.

Chapter 7 Trouble Shooting

This chapter is to help you correct some common problems you may come across. Prior to getting into the details of this chapter, please be sure that your application environment is compatible with the cutting plotter.

Note:

Before having your cutting plotter serviced, please make certain that the malfunction is in your cutting plotter, not the result of an interface problem or a malfunction in your computer or a software problem.



Why is the cutting plotter not functioning?

Possible Causes:

7.1 Non-Operational Problems

Check the following first:

- Does the AC power cord plug in properly?
- Does the AC power cord connected to the power connector properly?
- Does the power LED still illuminate?

Solutions:

If the LCM is able to display the message, the cutting plotter should be in a normal condition. Switch off the cutting plotter and turn it on again to see if the problem still existing.

If the LCM is not able to display any message, contact the technician from your dealer.

7.2 Operational Problems

Some mechanical problems or failure during operation will cause some problems. The error messages shown on the LCM present the problem first, and followed by recommended actions. If the problem still exists after the recommended actions have been done, have your cutting plotter serviced.

**Error, Check Media
Or Drum or X Motor**

This message indicates that there might be a problem on the **X axis**. Check if the drum is working well and if the media is well loaded. Correct the problem and re-power on to reboot system.

**Error, Check Media
Or Y Motor**

This message indicates that there might be an obstruction to carriage relating to a problem on the **Y axis**. Correct the problem and re-power on to reboot system.

**Error, Check Carriage
Sensor or VC Motor**

This message indicates that the blade up/down sensor malfunction. Re-power on to re-boot system. If the problem still exists, find a serviceman.

**Graph Was Clipped.
Data In Buffer**

This message indicates that the cutting exceeds the cutting limit. Reload larger media or re-scale the plot to a smaller size; then press the key followed by the display of LCM to continue.

7.3 Cutting Plotter/Computer Communication Problems

The messages showed below present problems in relation to cutting plotter/computer communication.

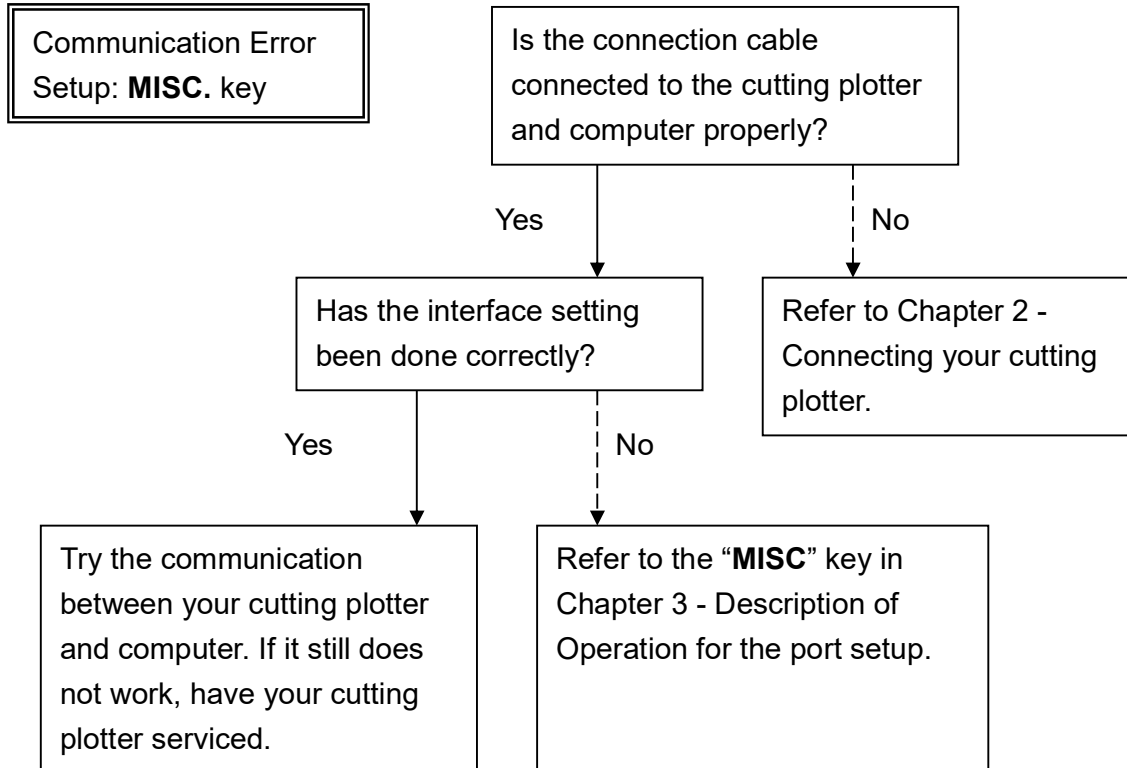

Note:

The computer also needs to set up compatible communication parameters to the cutting plotter set up.

HP-GL/2 Cmd. Error

If your cutting plotter can not recognize the HP-GL/2 or HP-GL commands, please check the HP-GL/2 or HP-GL commands applied to your cutting plotter are used properly.

7.4 Software Problems

Check the following first:

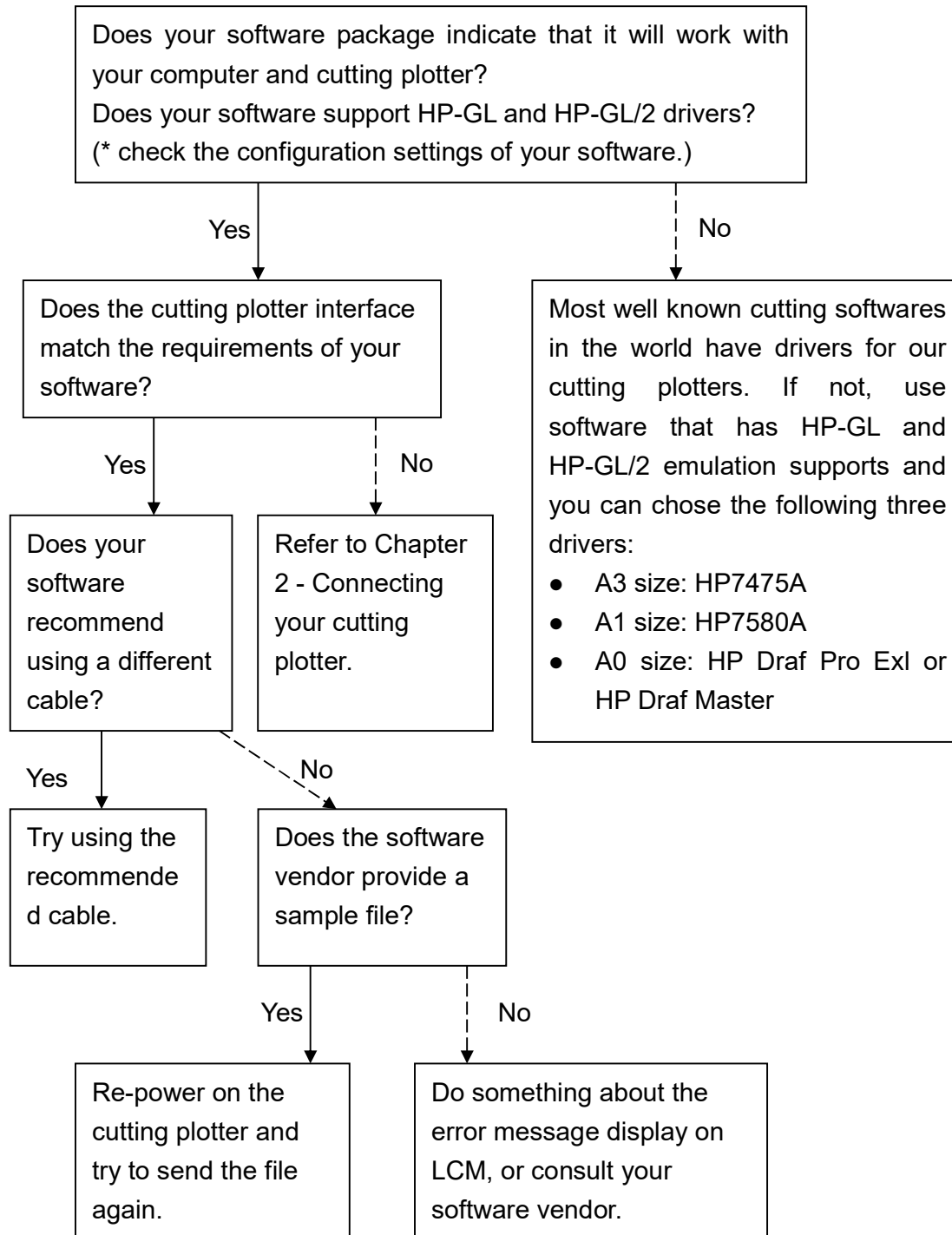

7.5 Cutting Quality Problems

Note: The daily maintenance of your cutting plotter is very important. Be sure to clean up the grid drum and pinch rollers regularly for better cutting accuracy and output quality.

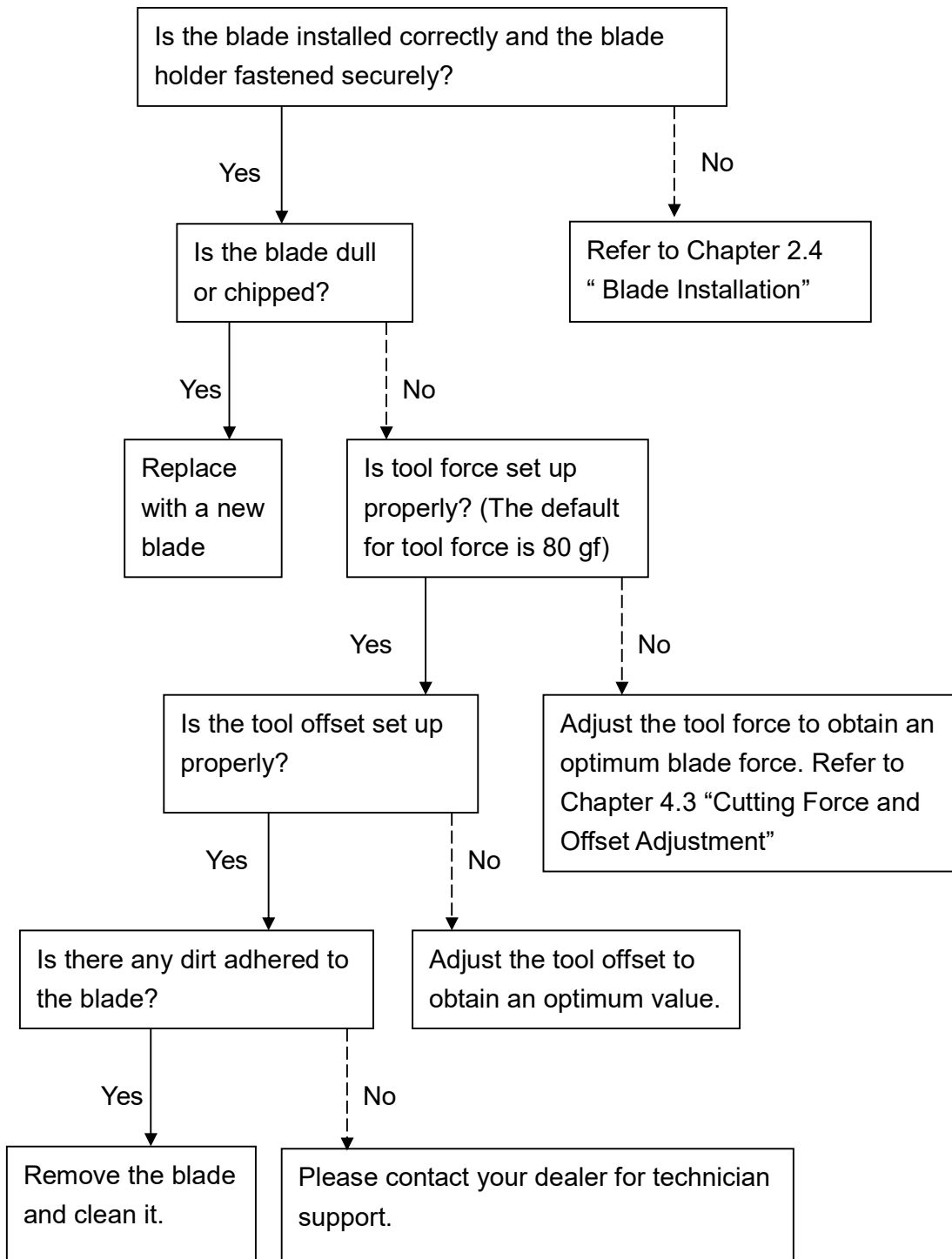





RX II series Specification

Model Number	RX II-61	RX II-101S	RX II-132S	RX II-183S
Operational Method	Roller-Type			
Max. Cutting Width	610mm (24in)	1010mm (40in)	1320mm (52in)	1830mm(72in)
Max. Cutting Length	50m (164ft)			
Max. Media Loading Width	810mm(31.88in)	1326mm(52.2")	1635mm(64.37")	2145mm(84.44")
Min. Media Loading Width	50mm (1.97in)			
Number of Pinch Rollers	2	3	4	6
Acceptable Material Thickness	0.8mm (0.03in)			
Drive Motor	DC Servo Control			
Cutting Force	5~600 g			
Max. Cutting Speed	1530 mm/sec (60 ips) (at 45° direction)			
Acceleration	4.2 G (gravity)			
Offset	0~1.0 mm (with an increase of 0.025mm)			
Memory Buffer	16 MB			
Interfaces	USB 2.0 (Full Speed), Serial (RS-232) and Ethernet			
Type of Command	HP-GL, HP-GL/2			
Mechanical Resolution	0.006 mm			
Software Resolution	0.025 mm			
Distance Accuracy	±0.254 mm or ±0.1% of move, whichever is greater			
Repeatability	±0.1mm			
Automatic-Aligning System	Completely Automatic Contour Cutting System for print to cut solution			
Curve & Arc Smoothing	Yes			
Configurable Origin	Yes			
Test Cut capability	Yes			
Tangential mode	Yes			
Over Cut	Yes			
Repeat	Yes			
Copy	Yes			
Pouncing	Yes			
Control Panel	LCD (20 digits x 2 lines), 15 Keys, 1 Power LED, 1 Green 51			
Diameter of Blade	2.5 mm			
Power Supply	100 ~ 240VAC 50/60Hz (auto switching)			
Power Consumption	251.8 watts			
Dimension (HxWxD) mm	437 * 1098 * 479	1147 * 1614 * 651	1147 * 1923 * 651	1147 * 2433 * 756
(HxWxD) in	17.2 * 43.2 * 18.8	45.2* 63.5 * 23.8	45.2 * 75.7 * 23.8	45.2 * 95.8 * 29.8
Net Weight	25kg	61.8kg	71.5kg	72kg
Auto Cut Off	Standard			
Max. Cut Off Width	696mm	1107mm	1417mm	1927mm
Stand	Optional	Standard		
Media Basket	Optional			
Operation	Temperature	15°C~30°C / 60°F~86°F		
Environment	Humidity	25% ~ 75%		

- Compatible with Windows 7 and above & MAC OS X 10.6 and above.
- The specification and data sheet may vary with different materials used. In order to obtain the best output quality, please maintain the machine regularly and properly.
- GCC reserves the right to change the specifications at any time without notice.
- GCC certified material in tracking is Avery MPI 3000.
- The above listed specification values are effective only when operated with media certified by GCC.

Blade Specification

265019700G	For cutting thick fluorescent and window tint film. Also for cutting detailed work in standard vinyl.
	The blade is 45° with Red Cap , 0.25 mm blade offset, and 2.5 mm blade diameter.
	
265017540G	For cutting reflective vinyl, cardboard, sandblast, flock, and stencil sharp edge.
	The blade is 60° with Green Cap , 0.50 mm blade offset, and 2.5 mm blade diameter.
	
265017550G	For cutting thin sandblast mask and stencil. The blade with sharp angle and special design, allowing it to maneuver around sharp corners.
	The blade is 60° with Blue Cap , 0.25 mm blade offset, and 2.5 mm blade diameter.
	
265017560G	For cutting small text and fine detail. Sharp blade with smallest offset.
	The blade is 50° with Black Cap , 0.175 mm blade offset, and 2.5 mm blade diameter.
	
265017530G	For thin and delicate media such as window tint.
	The blade is 25° with Yellow Cap , 0.25 mm blade offset, and 2.5 mm blade diameter.
	

About the Tool

A generic term referring to the blade that cuts the sheet, the pen that does plotting, and the LED bombsight (option) used for pointing to the reference point.

OFFSET is the distance that the blade tip is displaced from the centerline of the blade.

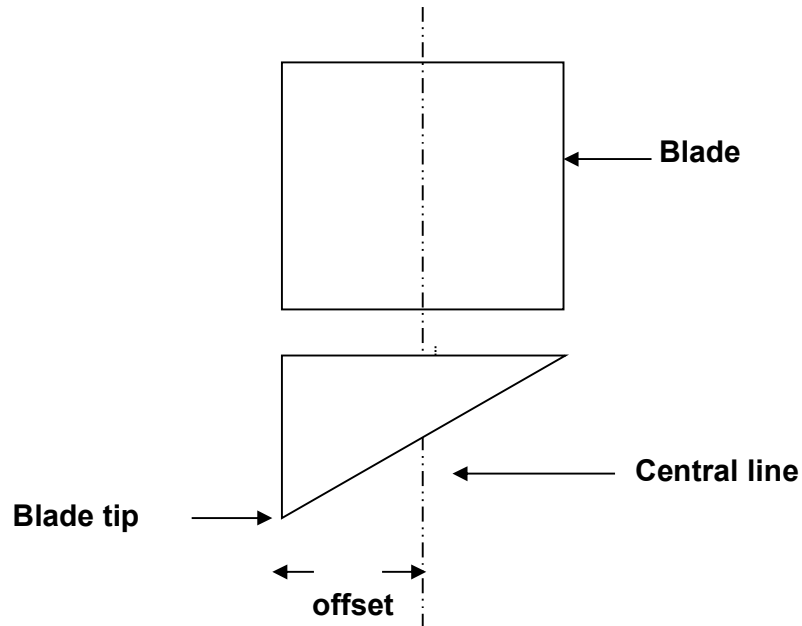

Protrusion Length of the Blade

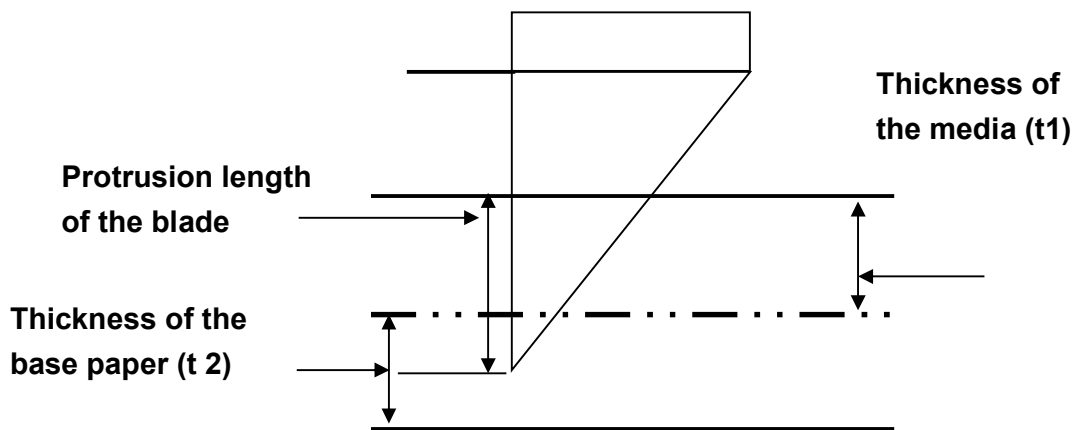

Length of protrusion = $t_1 + t_2 / 2$, but for your convenience you may just make it about 0.3mm ~ 0.5mm beyond the blade holder tip.

CorelDRAW Output Instruction

The following is an example of how to output the file with CorelDRAW.

User Instructions

1. Open CorelDRAW, finish editing all the files you wish to plot and select all the images at once.
2. Select “Outline Pen” to adjust the outline for cutting.

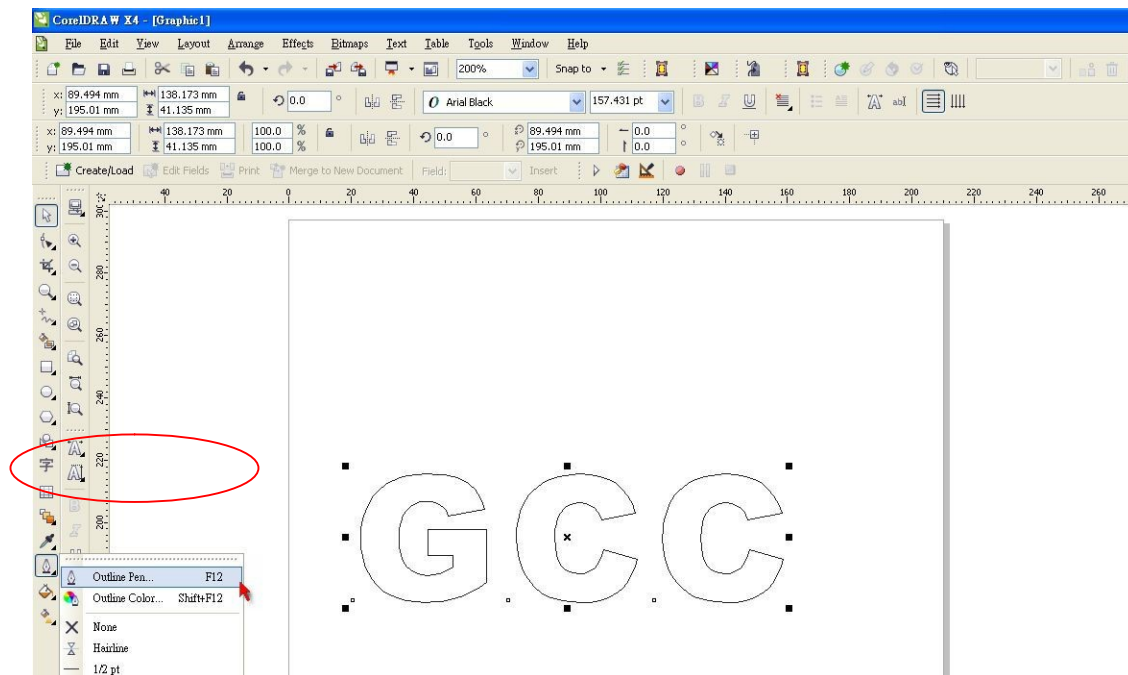

3. Adjust the value of pen width to 0.001 mm and click “OK” to save your input.

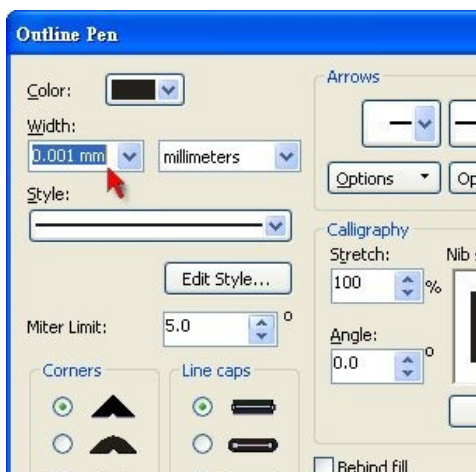

4. Select “ File → Print” to output the file to your cutters.

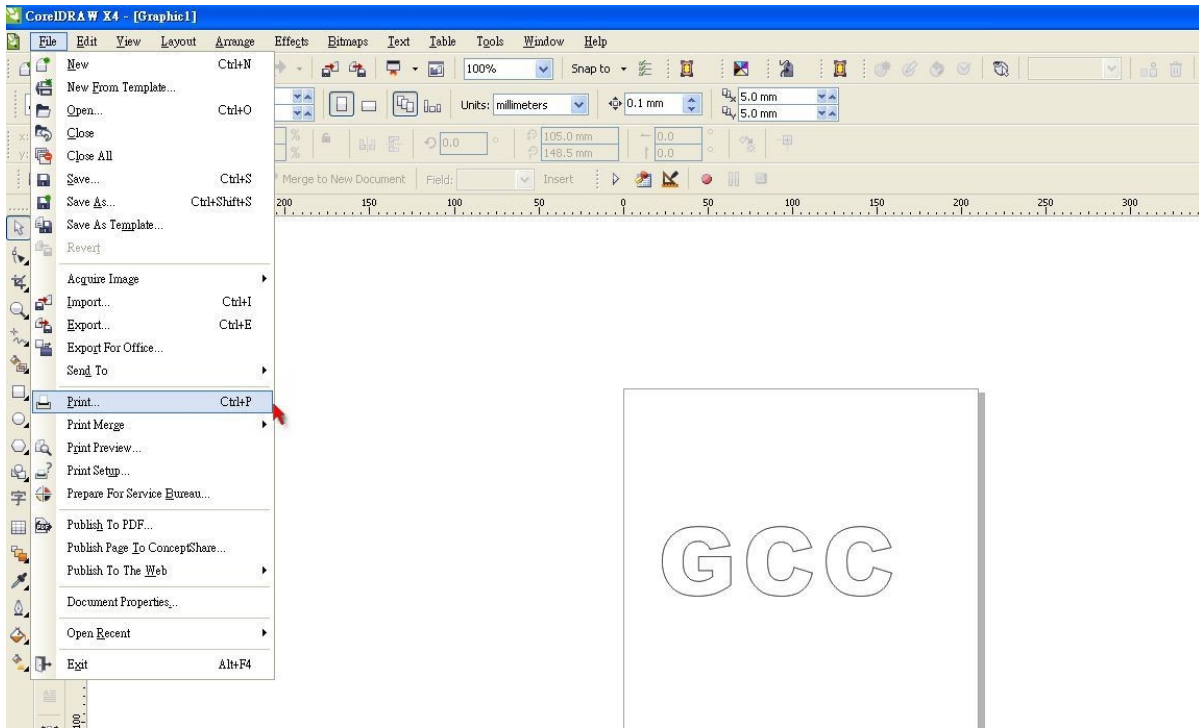

5. Choose the correct model you have installed.

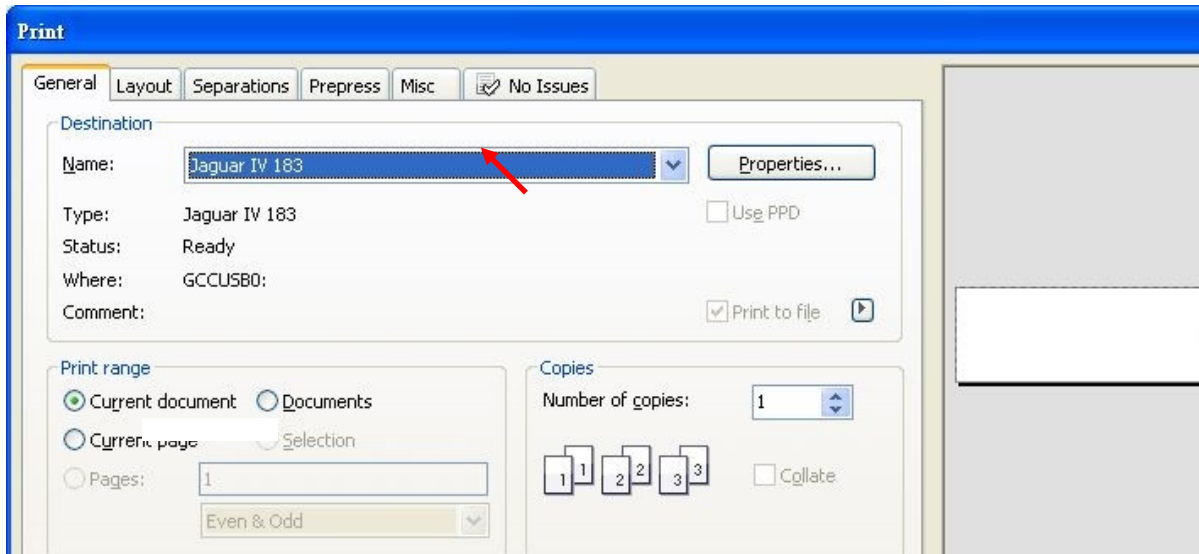

6. Choose the “Layout page” and click the “Reposition images to: → Bottom left corner”. **Please note that you must put your image at the bottom left corner.**

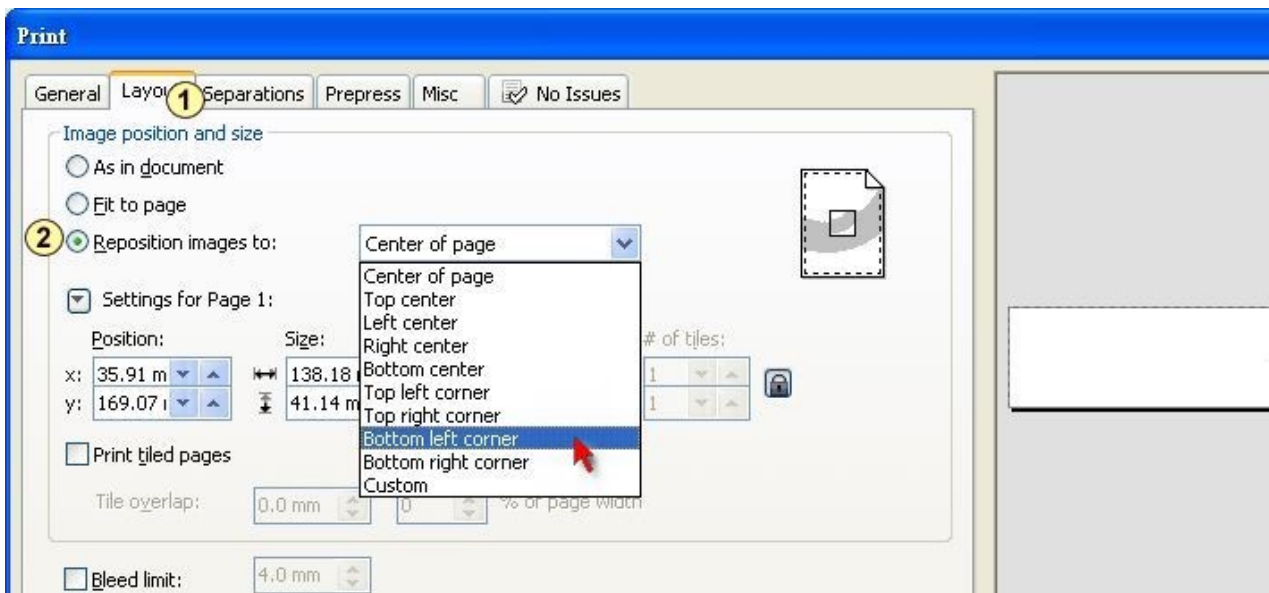

7. Go back to the General page and check that your image is at the bottom left corner. Click “Print” and get a wonderful cutting image.

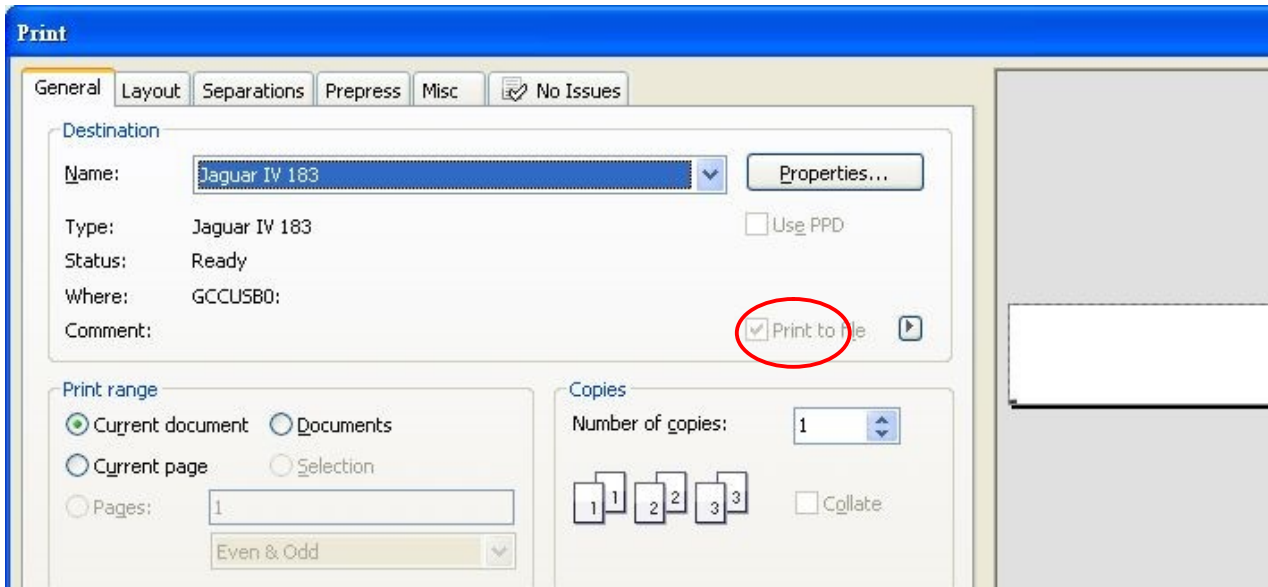

CorelDRAW Plug-In Instruction

AASII VBA Installer is applicable for CorelDRAW Version 13, 14, 15, 16, 17, 18

Installation

Please refer to Step 8 in Chapter 2.7.1.2 Driver Installation to install AAS plug-in for CorelDRAW.

Run CorelDRAW AAS Plug-in

Step 1 Run CorelDRAW to edit your graphics and select all images at once when you wish to plot.

Step 2 Select “Tools→Macros→Run Macro.” Then select **Global Macros (GCCAASII_Draw13.gms)** under the “Macros in” manual, and press “Run”.

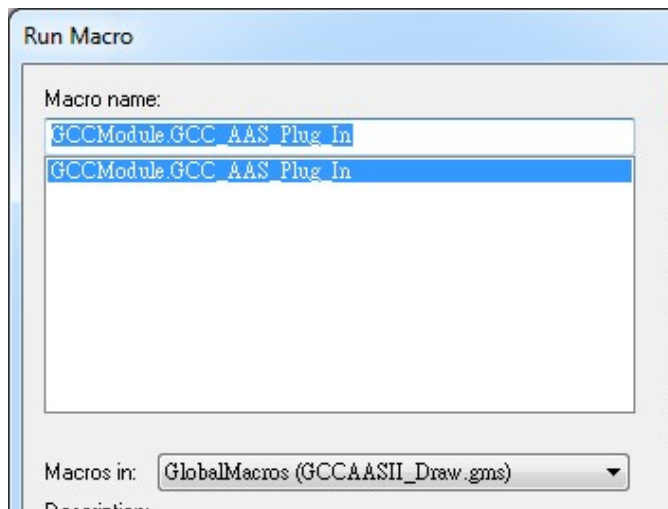

Step 3 Click on “Apply” and select whether you would like to add the registration marks by page size or by object.

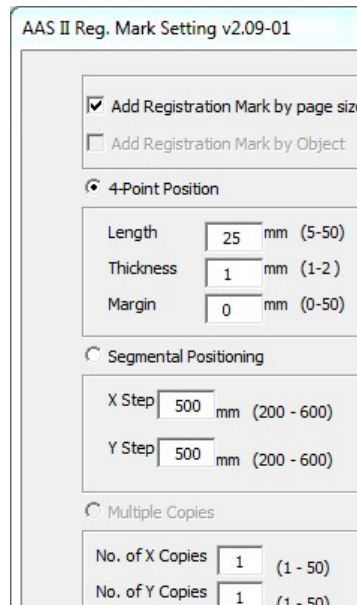

Step 4 Now you can print out the image file with registration marks.

Note: “Add Registration Mark by Object” will be the default selection if you click on the image whereas “Add Registration Mark by page size” will be the default one when the blank area on the page is clicked.

You can also add a Hot Icon for the AAS Plug-in

Select “Tools→ Options→ Workspace→ Customization→ Commands→ Macros→ GCCMadual.GCC_AAS_Plug_In” and Click OK.

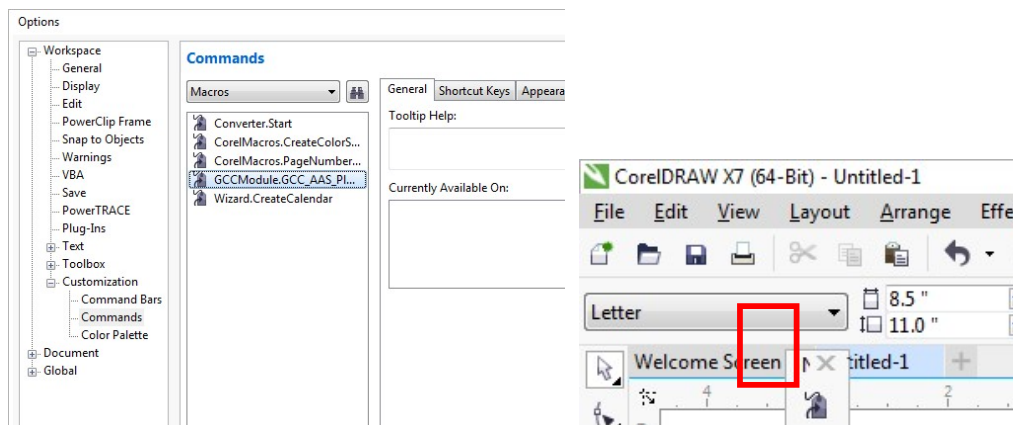

Add Registration Mark by page size

If you tick “Add Registration Mark by page size” as shown in the figure below and click “Apply”, your registration marks will be created automatically (please see Figure A3-1).

Note:

1. The length setting will be in the range of 5-25mm according to your page size.
2. Please **DO NOT** make any changes to the “Origin” section when you choose to add registration marks by page size as indicated below otherwise the position of the marks will be changed (please see Figure A3-2).

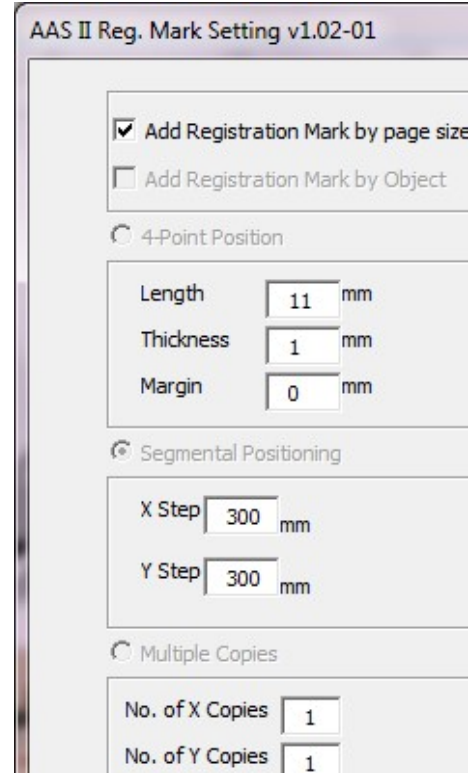

Figure A3-1

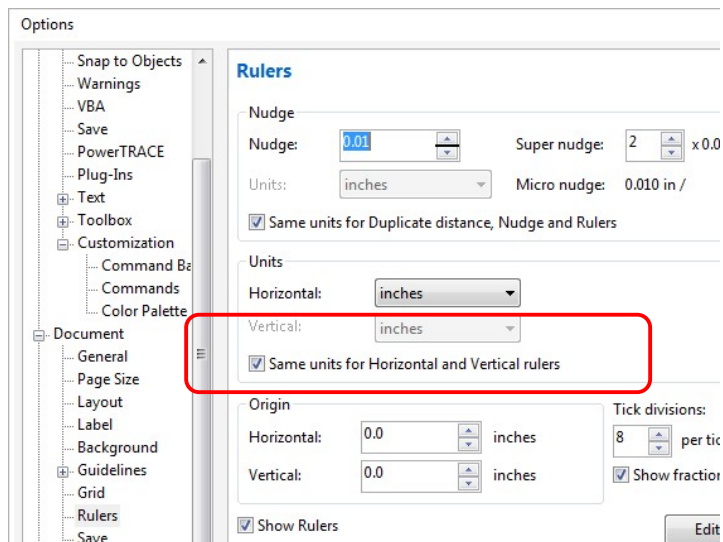

Figure A3-2

The system will create the 4 marks on the 4 corners of the page as shown in the picture below wherever you move your image.

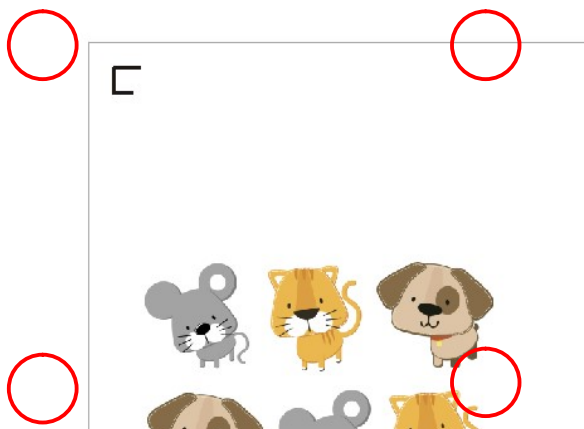

Figure A3-3

Workable area

It allows users to edit and cut graphics in the area outside the registration marks when adding registration marks by page.

For A4 size media sheet, the workable area is 2.5mm extended from the registration mark on left and right sides and 4.5mm extended from the registration mark on top side. On the bottom side, it is suggested to leave at least 25mm margin from the edge of media sheet to prevent sheets dropping or any error occurred while media sizing.

For A3 size media sheet, the workable area is 10mm extended from the registration mark on the left side, 9mm extended from the registration mark on the right side and 11mm extended from the registration mark on top side. On the bottom side, it is suggested to leave at least 25mm margin from the edge of media sheet to prevent sheets dropping or any error occurred while media sizing.

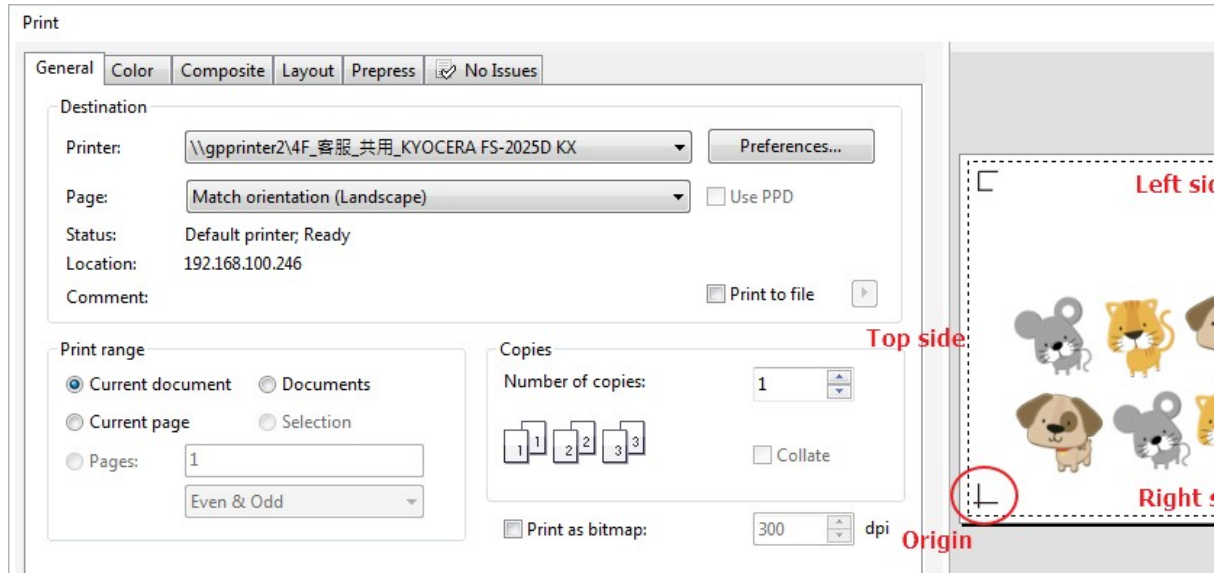

Note: Select “**Edge**” mode when media sizing to allow the media sheet to be unrolled. If you select “**Single**” mode, the media sheet will not be able to be moved back and hence fail to be detected by front paper sensor.

Add Registration Mark by Object

If you tick “Add Registration Mark by Object”, you will be offered three options of registration marks as shown below.

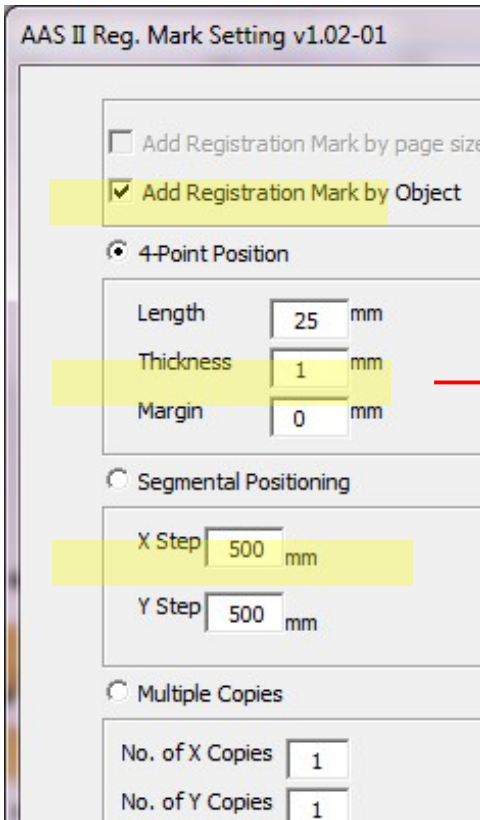

Figure A3-4

4-Point Positioning

- Length: The length of marks
→ Range: 5mm~50mm
→ Optimized Setting: 25mm
- Thickness: The line thickness of marks
→ Range: 1mm~2mm
→ Optimized Setting: 1mm
- Margin: The distance between marks and images
→ Range: 0mm~50mm
→ Optimized Setting: 5mm

Segmental Positioning

- X Step: The distance of intermediate position on the X axis
- Y Step: The distance of intermediate position on the Y axis
→ Range: 200mm~600mm
→ Optimized Setting: Less than 500mm

Multiple Copies

- No. of X Copies: The numbers of copies on X axis
- No. of Y Copies: The numbers of copies on Y axis
→ Range: 1~50. (The more copies you make, the more time is needed for data transmission.)
→ Numbers of X Copies * Numbers of Y Copies = The total amount of image copies
- Copies with outline: To show outlines of image graphics

Note: The values entered in the “4-Point Positioning” section (length, thickness and margin) will still be applied when you tick “Segmental Positioning” or “Multiple Copies”.

4-Point Positioning

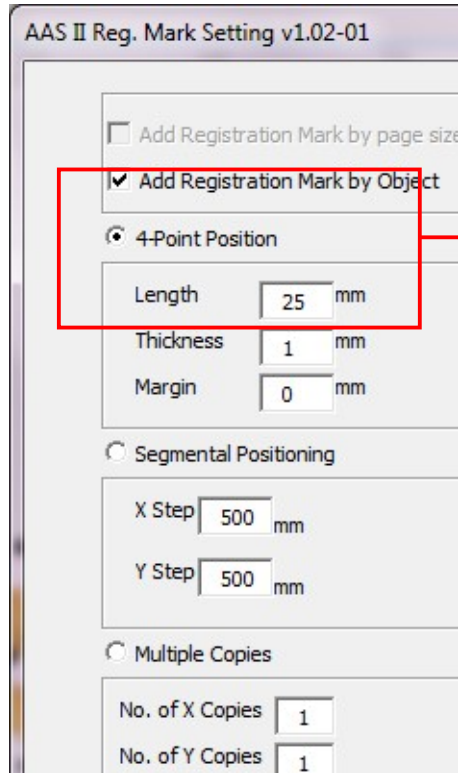

4-Point Positioning

- Length: The length of marks
→ Range: 5mm~50mm
→ Optimized Setting: 25mm
- Thickness: The line thickness of marks
→ Range: 1mm~2mm
→ Optimized Setting: 1mm
- Margin: The distance between marks and images
→ Range: 0mm~50mm
→ Optimized Setting: 5mm

Figure A3-5

The system will create the 4 marks as shown in the picture below.

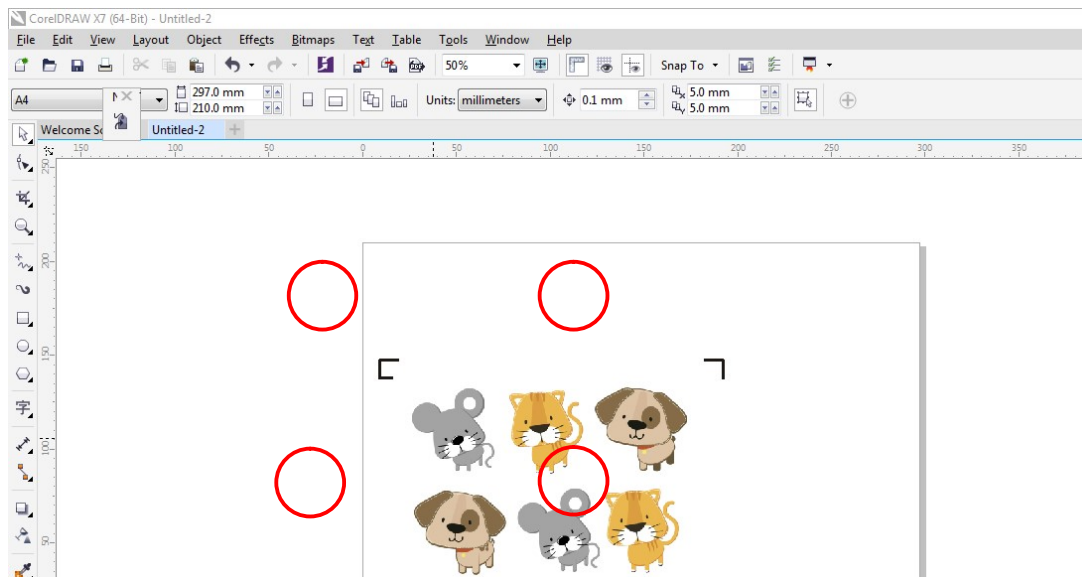
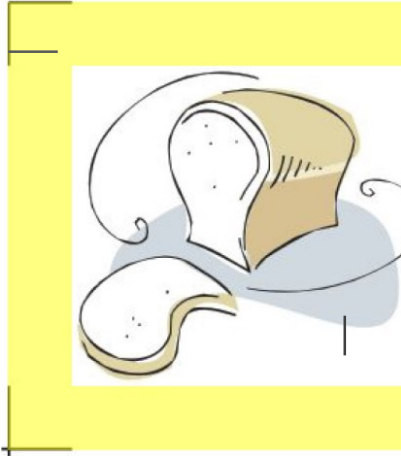
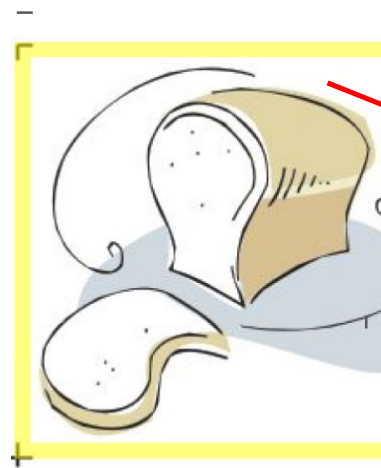

Figure A3-6

Note:

1. To save your materials, in addition to amending object margins, you can also adjust the length of the registration marks (5mm minimum) when you apply 4-Point Positioning (see table 1 for suggestions based on different material sizes). The smaller the size is, the smaller the distance between the object and the registration marks is (see the figures below).

**Figure A3-7****Figure A3-8**

Page size (unit: mm)	Suggested mark length (unit: mm)
A6 (105 x 148)	5
A5 (148 x 210)	8
A4 (210 x 297)	11
A3 (297 x 420)	16
A2 (420 x 594)	23
A1 (594 x 841) and above	25*

Table 1

*25mm is the suggested value for the registration mark length

2. The size of the registration marks would affect the accuracy of registration mark detection so please make sure the amount you enter is reasonable.
3. If you change the paper size, you will have to reset the registration marks otherwise the previous setting will be applied.

Segmental Positioning

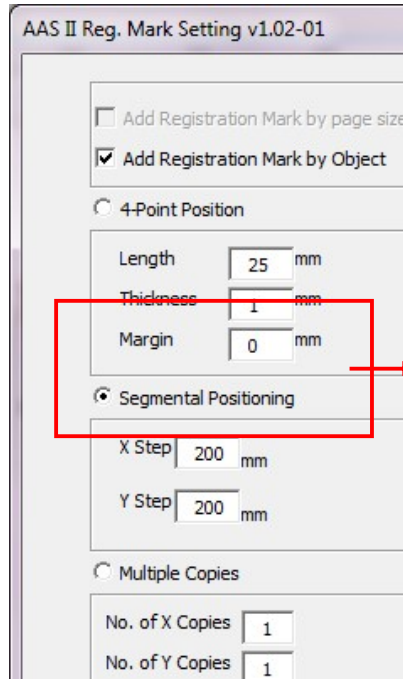

For precise cutting quality, it is suggested to select “Segmental Positioning” when you are working on an extra long or large-sized image to increase cutting accuracy.

Segmental Positioning

- X Step: The distance of intermediate position on the X axis
- Y Step: The distance of intermediate position on the Y axis
- Range: 200mm~600mm
- Optimized Setting: Less than 500mm

Figure A3-9

The system will create the as shown in the picture below

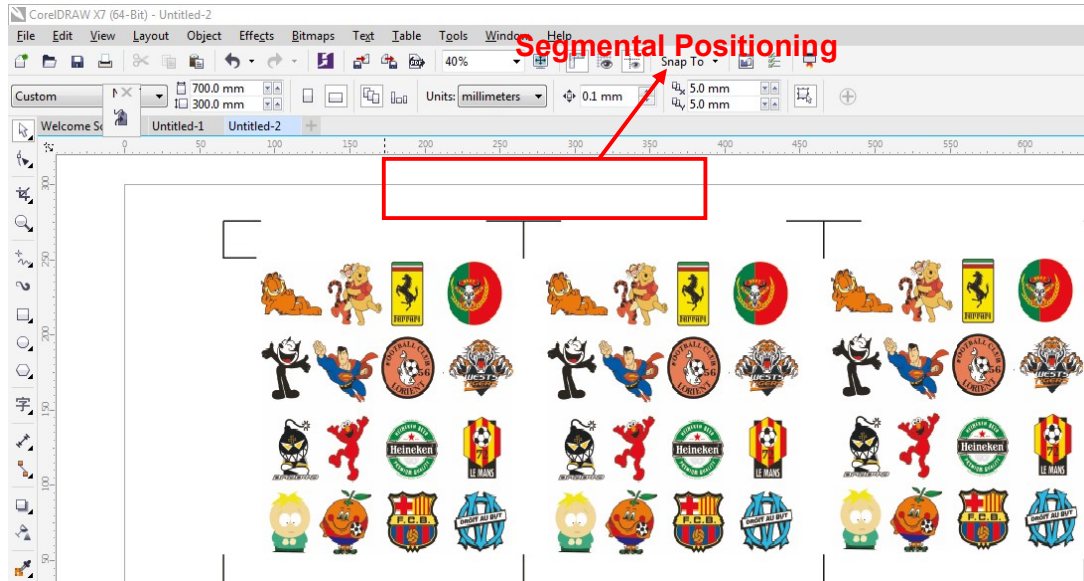
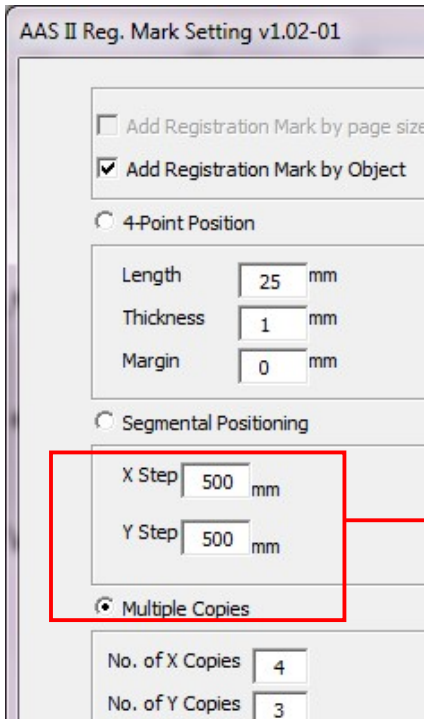

Figure A3-10

Segmental Positioning will be applied to Multiple Copies when the object to be copied is of large size (with the length or width over 200mm) to increase the accuracy of registration mark detection.

Multiple Copies

It is suggested to select “Multiple Copies” when you would like to make several copies of one image on your material to increase cutting accuracy.



Multiple Copies

- No. of X Copies: The numbers of copies on X axis
- No. of Y Copies: The numbers of copies on Y axis
 - Range: 1~50. (The more copies you make, the more time is needed for data transmission.)
 - Numbers of X Copies * Numbers of Y Copies = The total amount of image copies
- Copies with outline : To show outlines of image graphics

Figure A3-11

The system will create the as shown in the picture below.

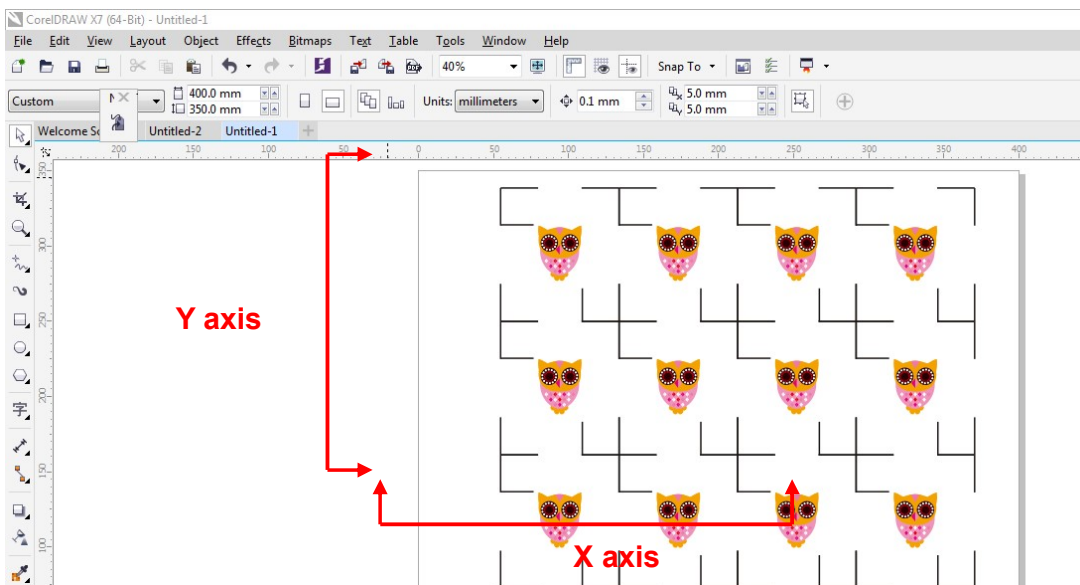

Figure A3-12

Contour cutting through CorelDraw

Step 1 Position the paper with registration marks printed by your printer on the GCC cutter.

Step 2 Select “Files→Print”.

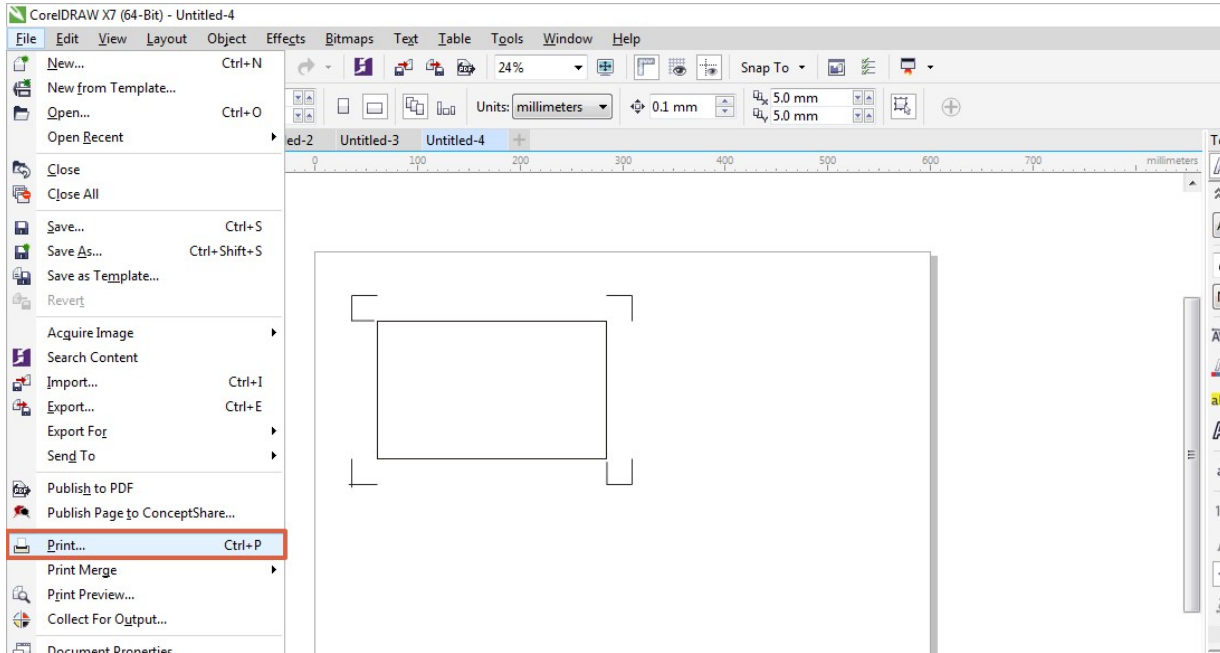

Figure A3-13

Note: if you use CorelDraw X5 and later, you must follow the steps below.

Step 1 Click the “color” page and go to the “Color conversions performed by:” and then select the model name of you cutter (please refer to Figure A3-14).

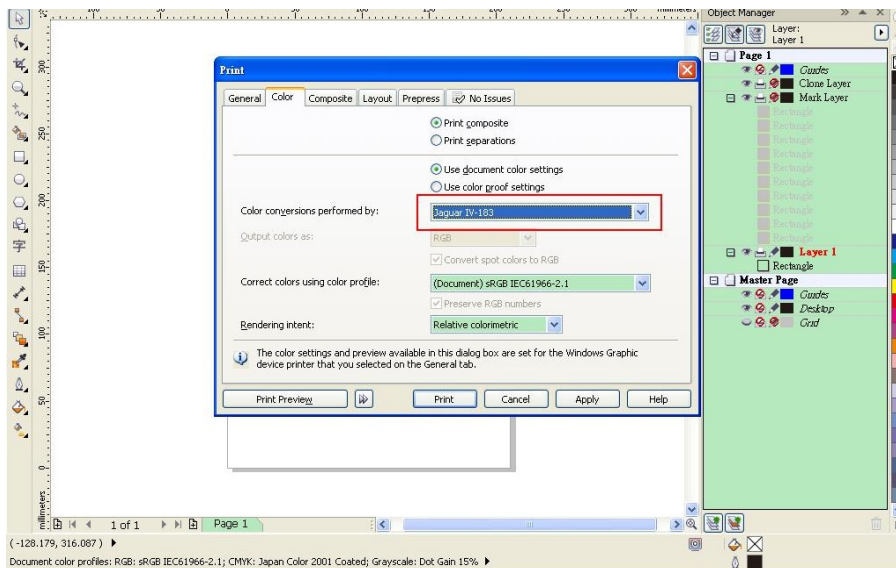

Figure A3-14

Step 2 Go to the “Layout” page and select Bottom left corner at “Reposition images to”.

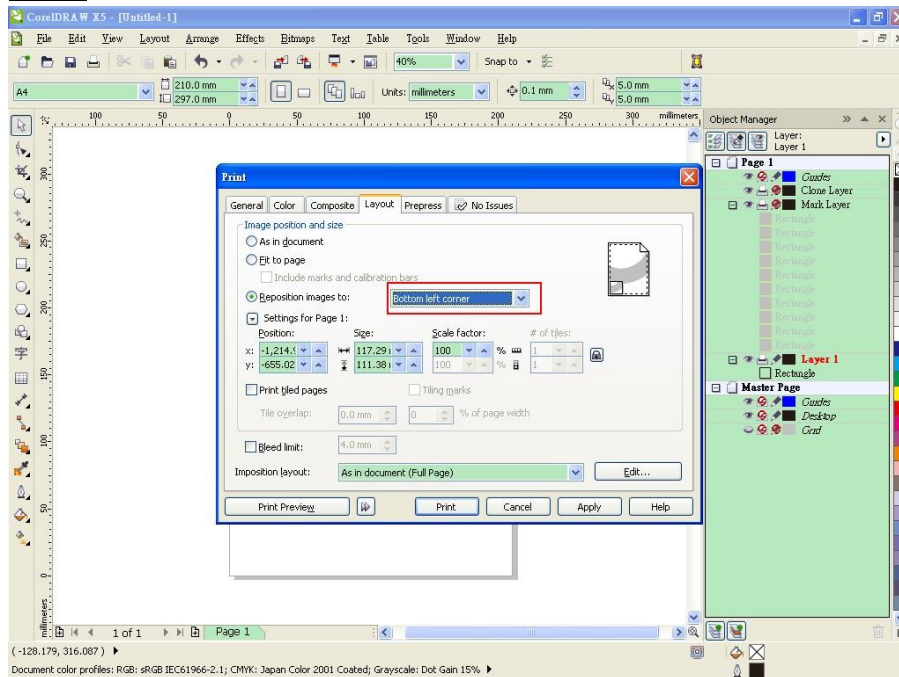

Figure A3-15

Step 3 Click “Print”.

Illustrator Plug-In Instruction

AASII VBA Installer is applicable for Adobe Illustrator Version CS4, CS5, CS6, CC.

Installation

Please refer to Step 8 in Chapter 2.7.1.2 Driver Installation to install AAS plug-in for Adobe Illustrator.

Printer Setting

Step 1 Go to Control Panel, right click on the printer and select Printer Properties to open the Printer Properties page

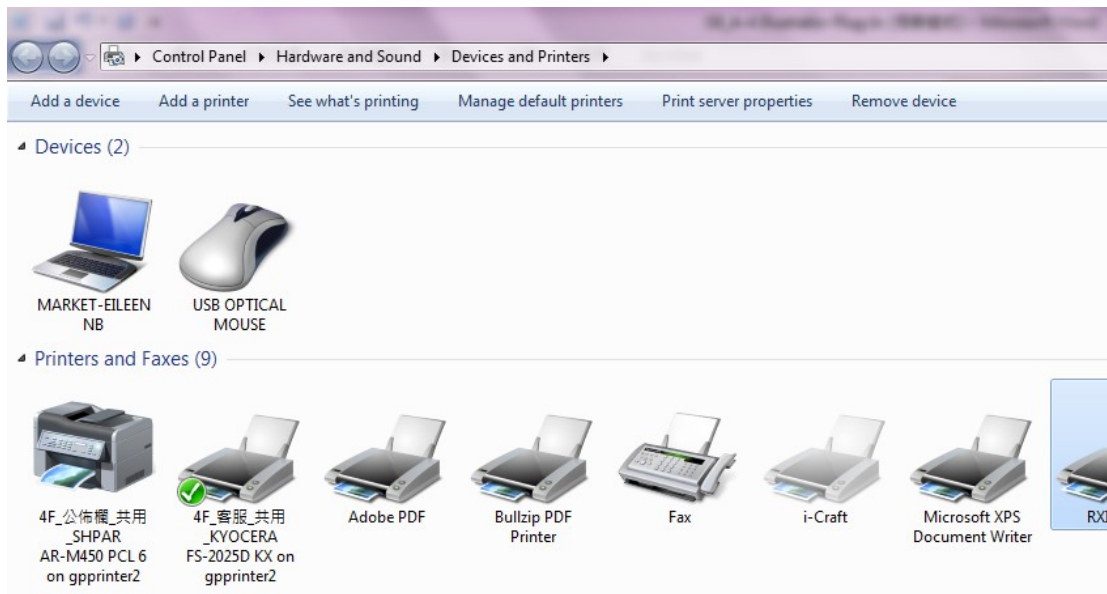

Step 2 Go to the Advanced page and make sure the “Enable advanced printing features” box is unchecked.

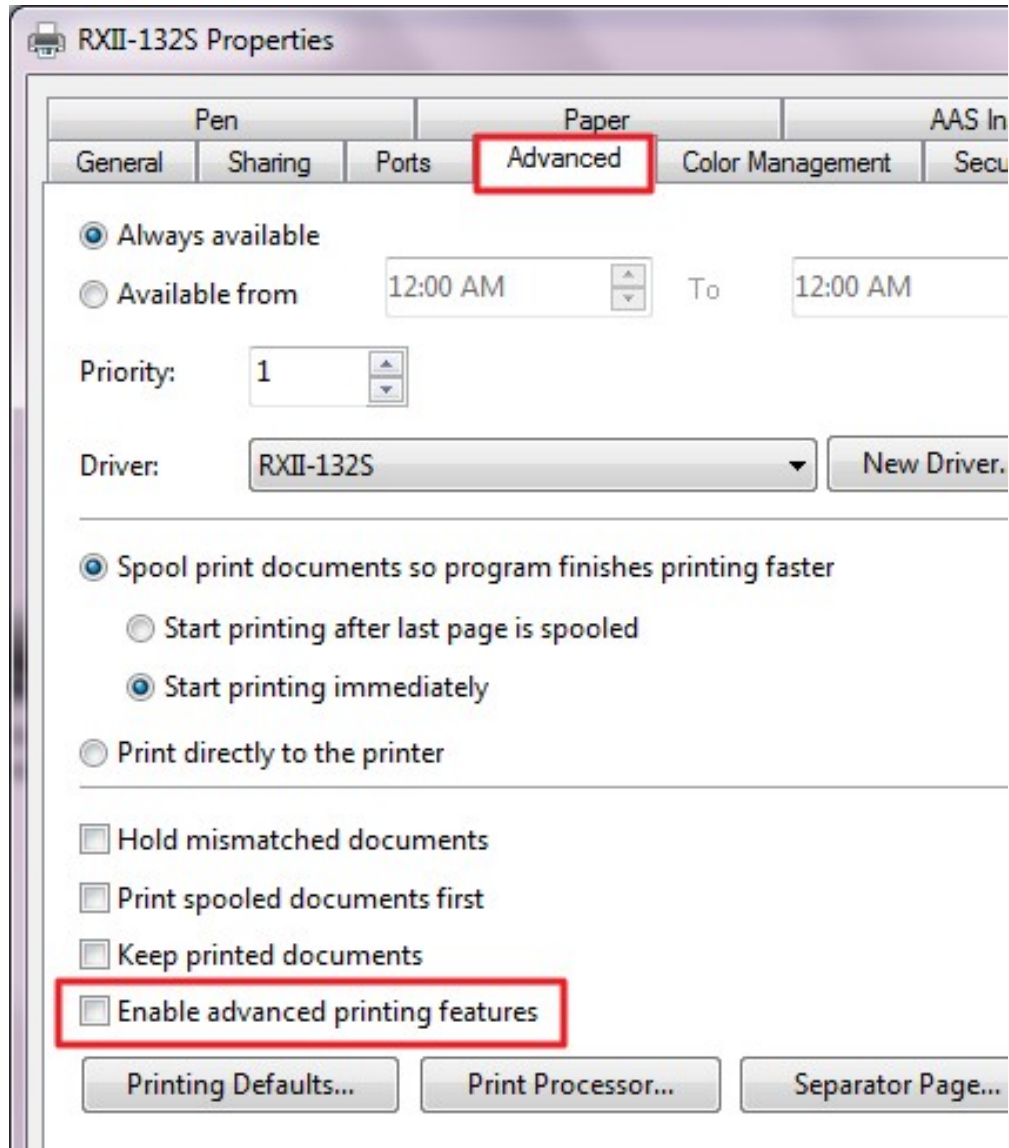

User Instructions

Step 1 Open Illustrator.

Step 2 Edit your image and create a contour line (**Note:** you must have the line width set as 0.001mm).

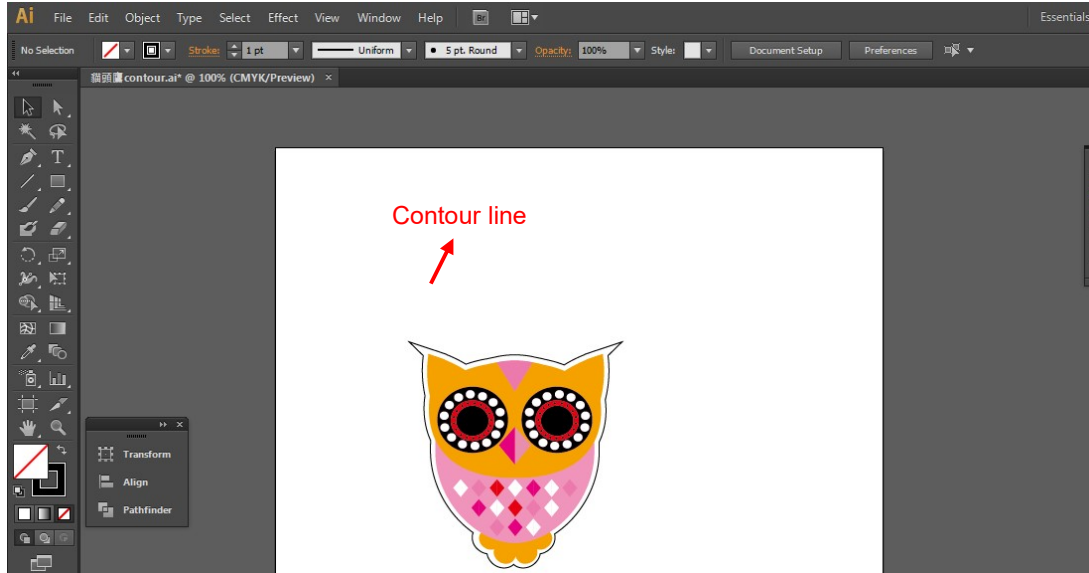

Step 3 Click on the image and apply the AAS function (File→Scripts→_AASII_Plug_In).

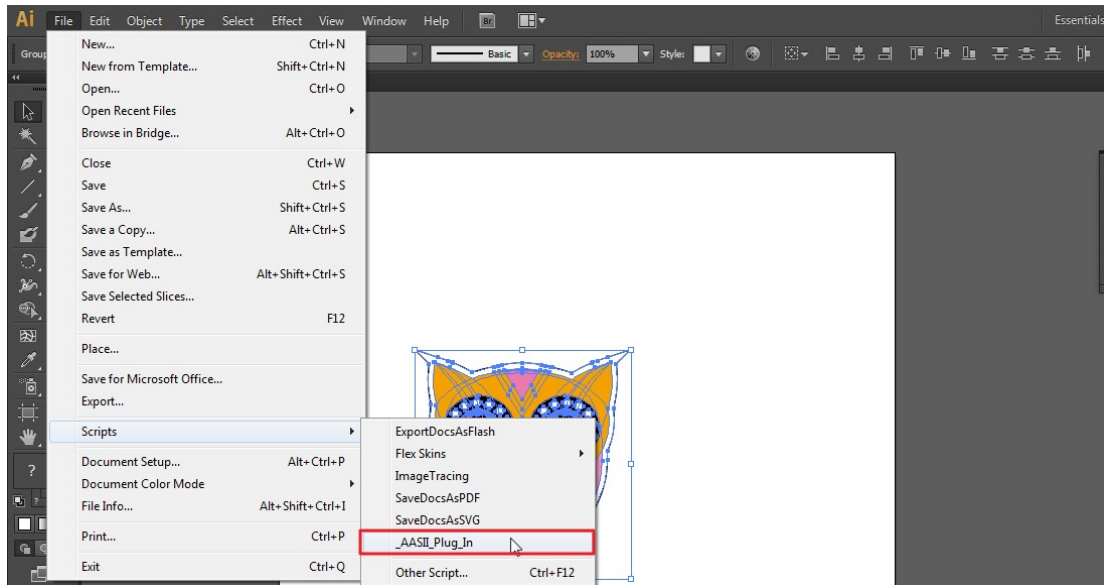

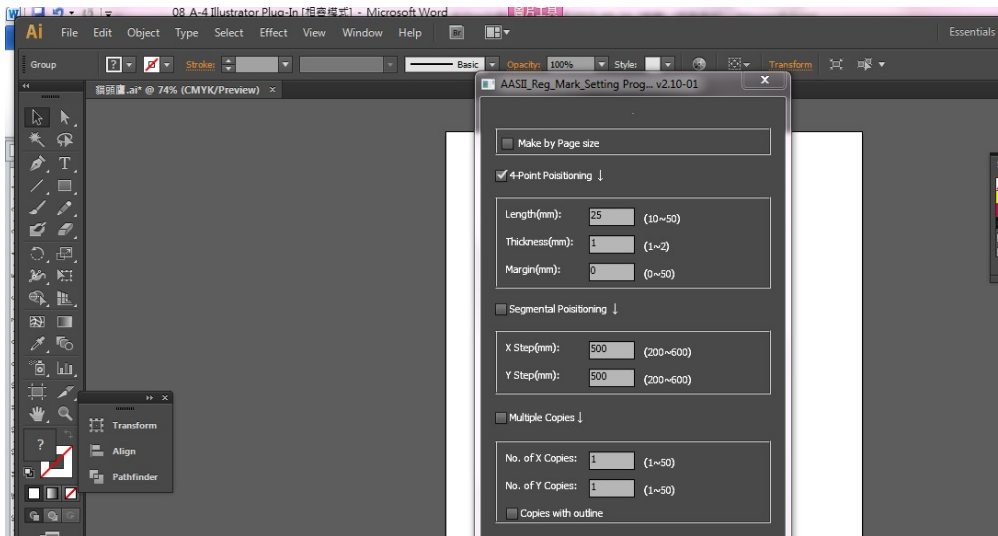
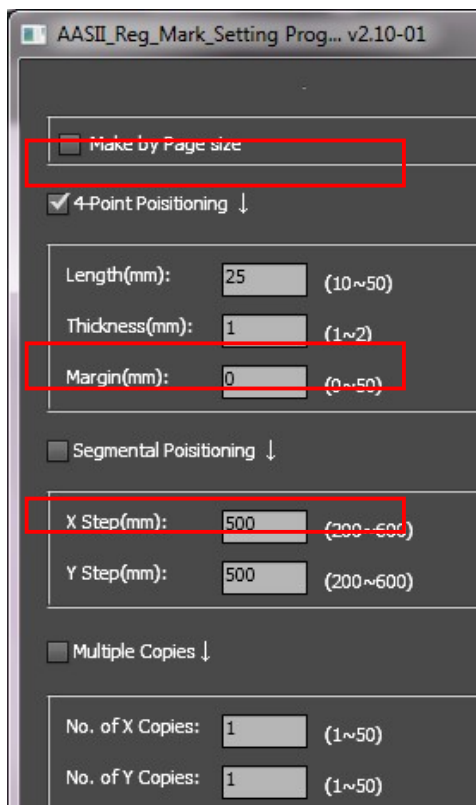
Step 4 Select the registration marks needed**Step 5** Three types of registration marks are introduced here: 4-Point Positioning, Segmental Positioning and Multiple Copies.**Note:**

The values entered in the “4-Point Positioning” section (length, thickness and margin) will still be applied when you tick “Segmental Positioning” or “Multiple Copies.”

Step 6 Confirm the registration marks (the 4-Point Position mark is used as an illustration in the following steps).

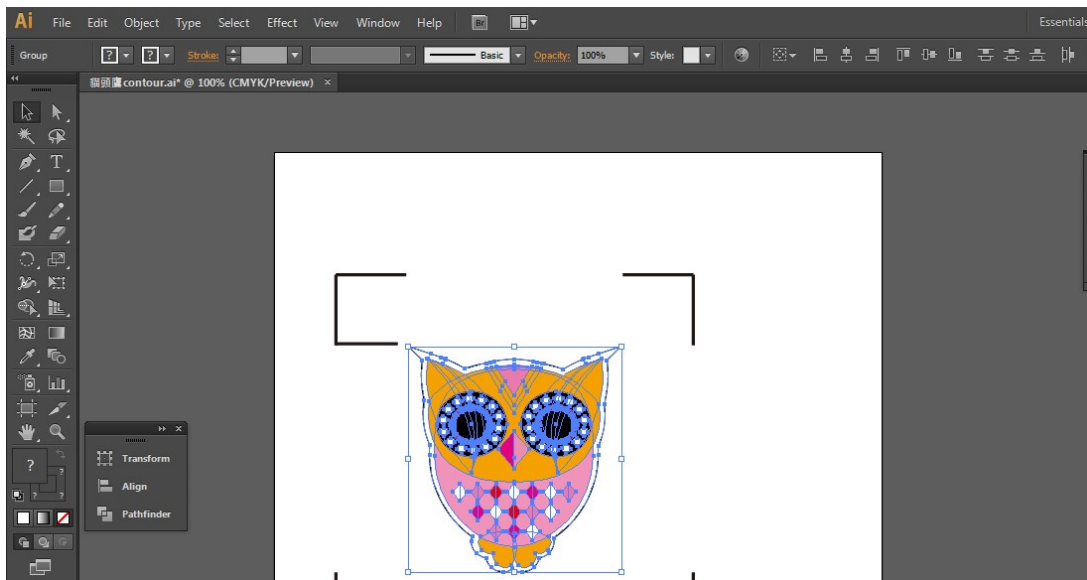

Step 7 Click on the blank area on the page and then click “Document Setup”.

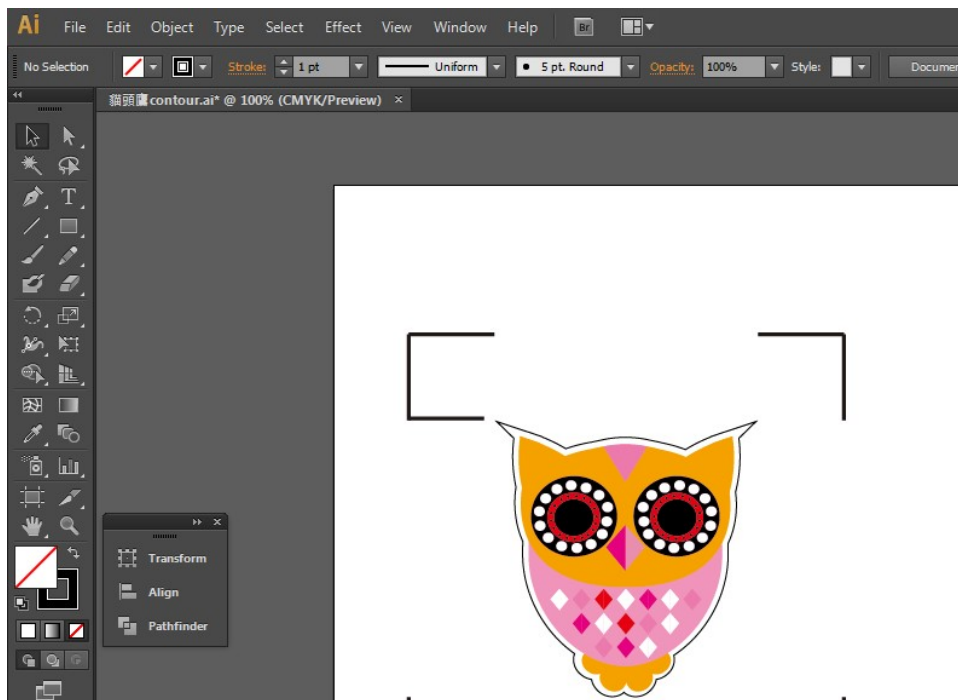

Step 8 Hit “Edit Artboards”.

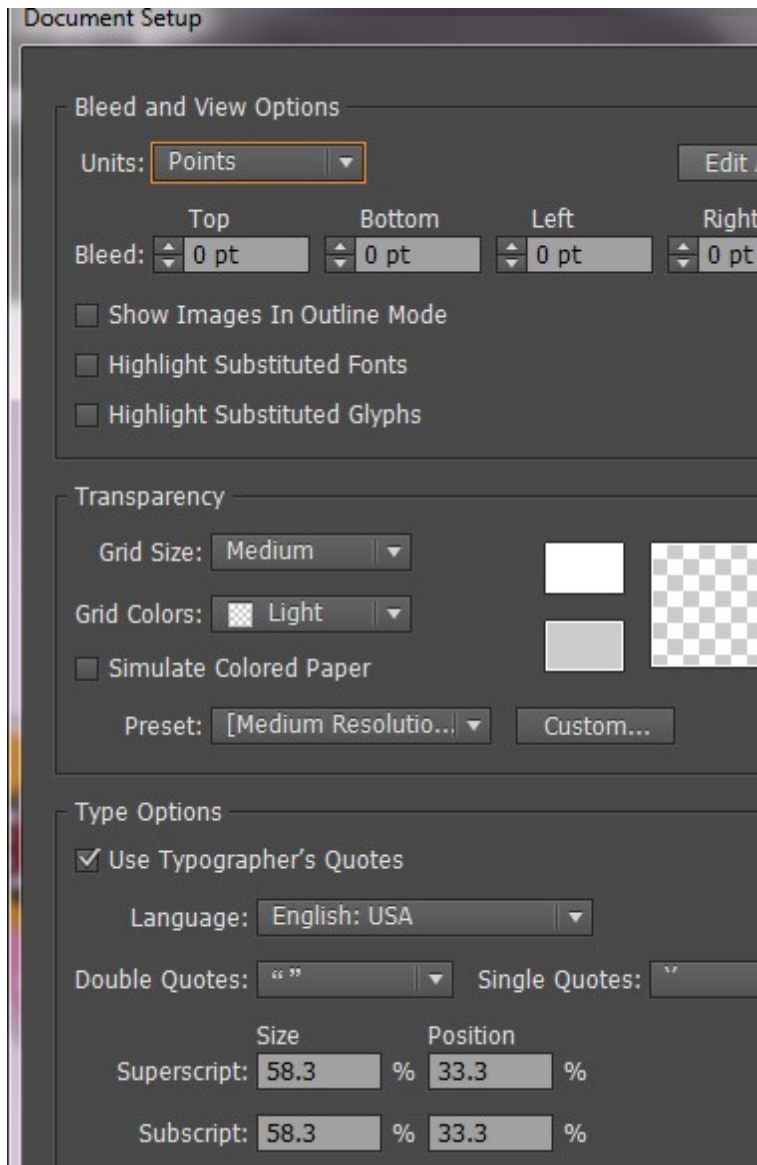

Step 9 Click on “Presets → Fit Artboard to Artwork bounds”.

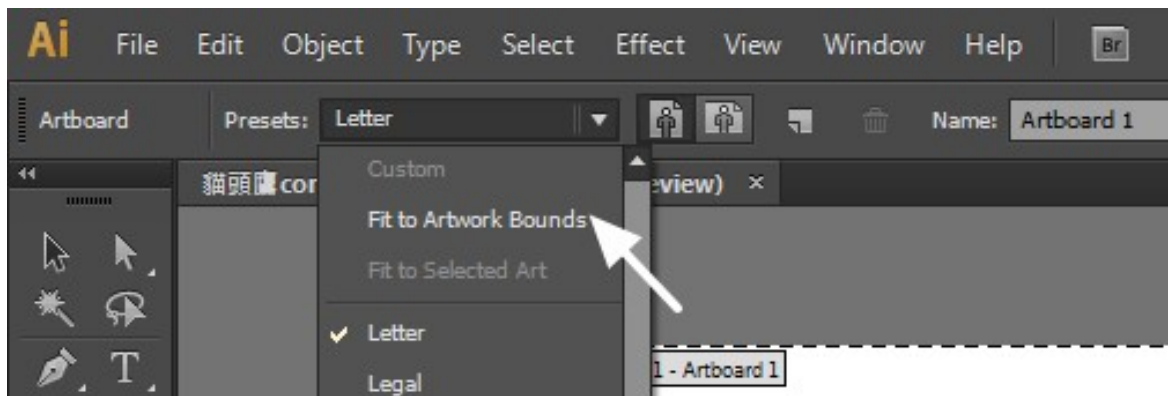

Step 10 Please move your mouse to the tool bar on the left when step 9 is finished and then click “Selection Tool”.

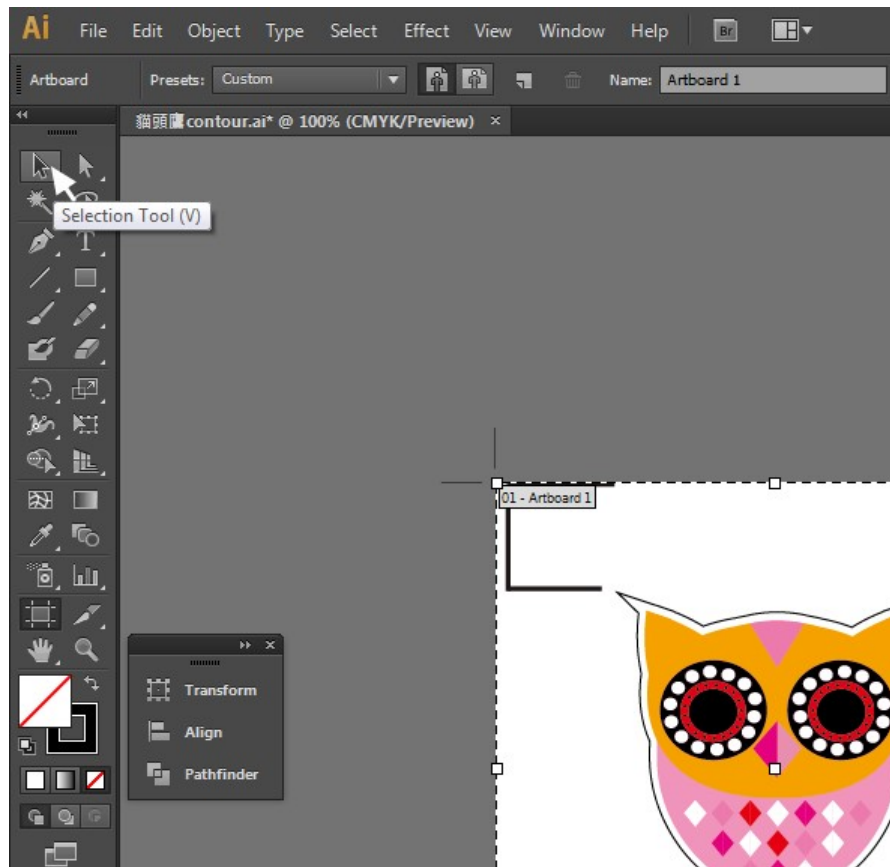

Step 11 This will take you back to the edit mode.

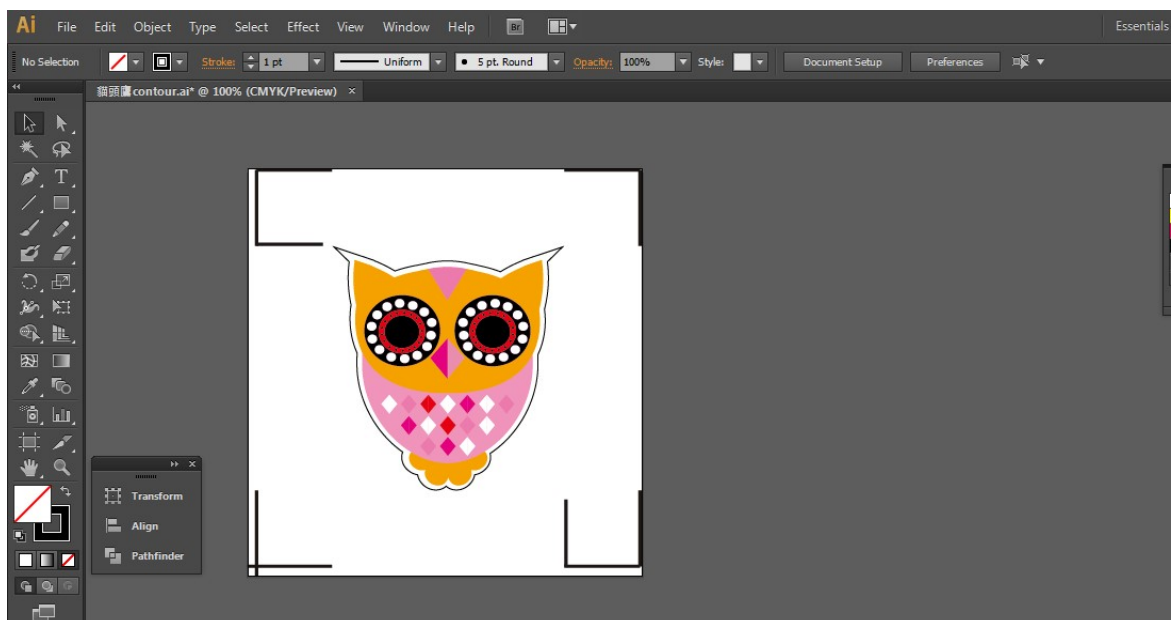

Step 12 Print out the file with the contour line and the registration marks.

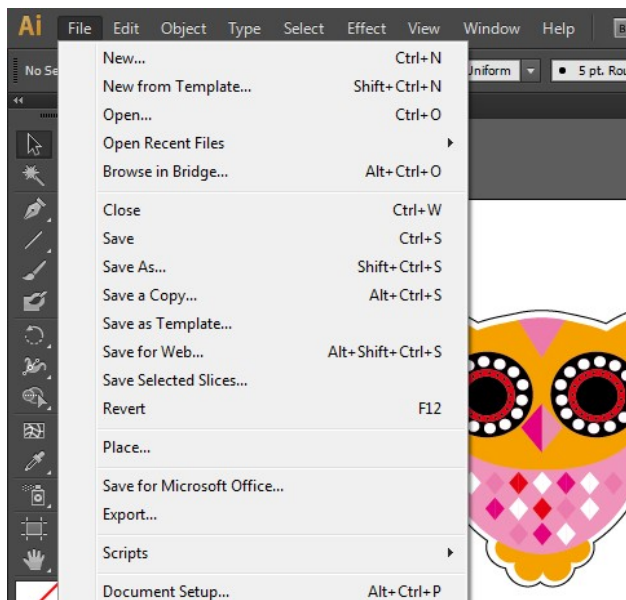

Step 13 Place the printed file on the cutter, lower the pinch rollers and then position the carriage at the origin of the registration marks.

Step 14 Send the file to the cutter.

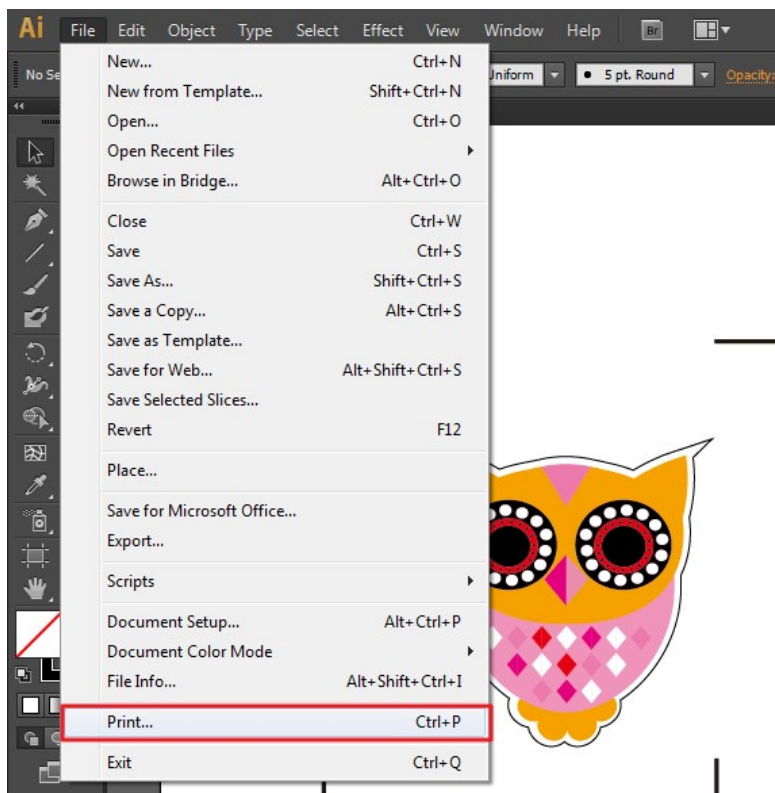

Step 15 Select the cutter model, position the object in the bottom left corner.

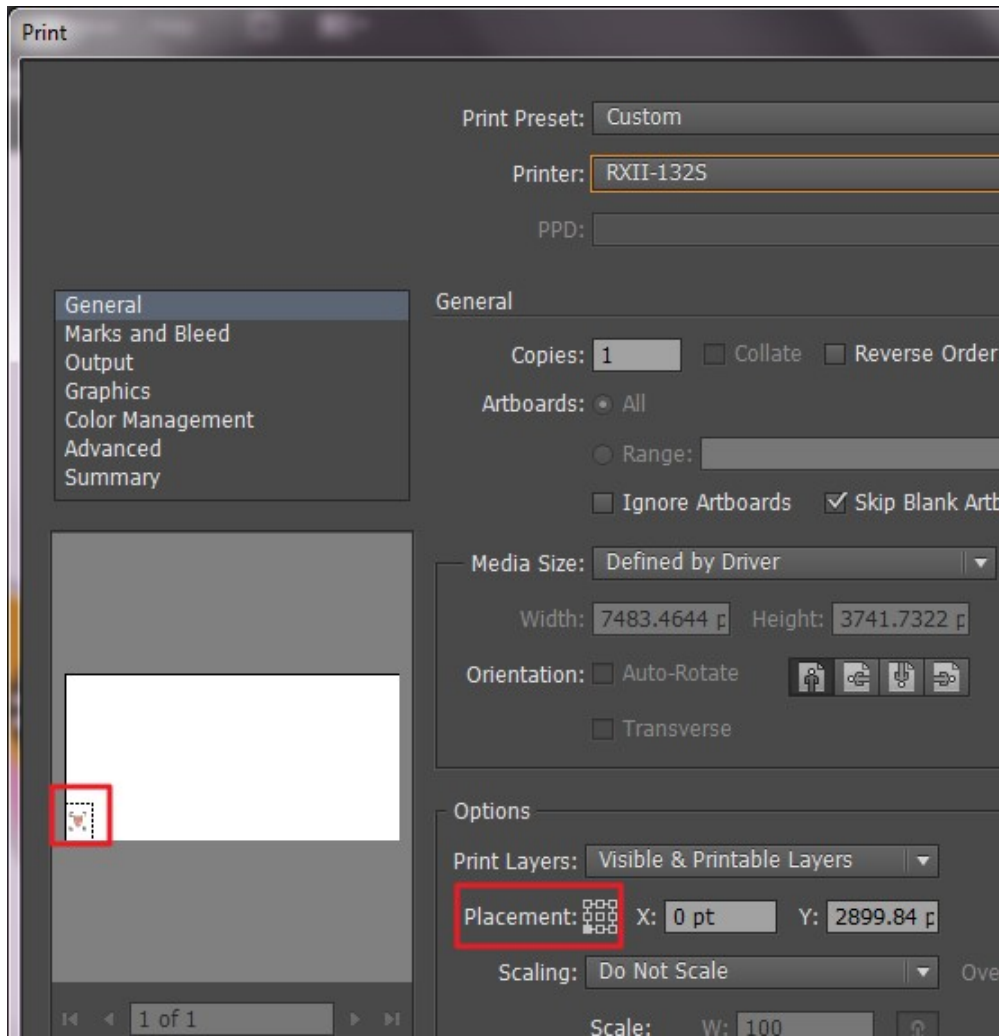

Step 16 Your job is now completed.

Add Registration Mark by page size

If you want to create registration mark by page size, select the object, go to “Scripts” under “File” and select “_AASII_Plug_In”

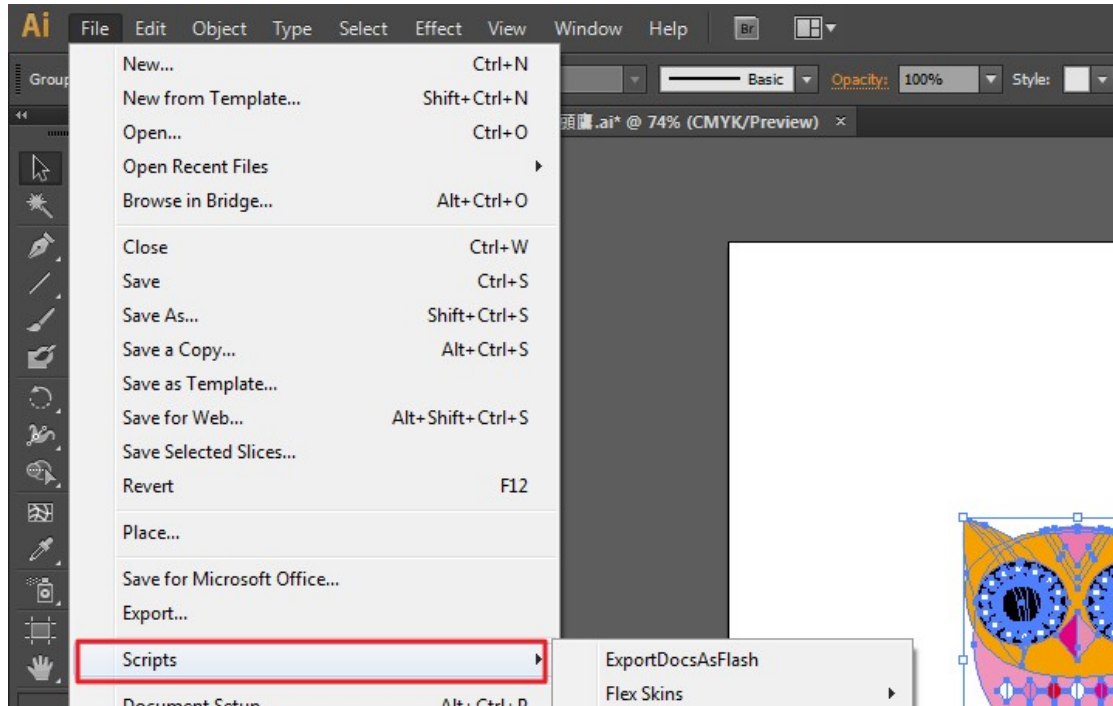

Tick “Make by page size” and click “Apply” and the registration mark will be created on the 4 corners of the page automatically, shown as below.

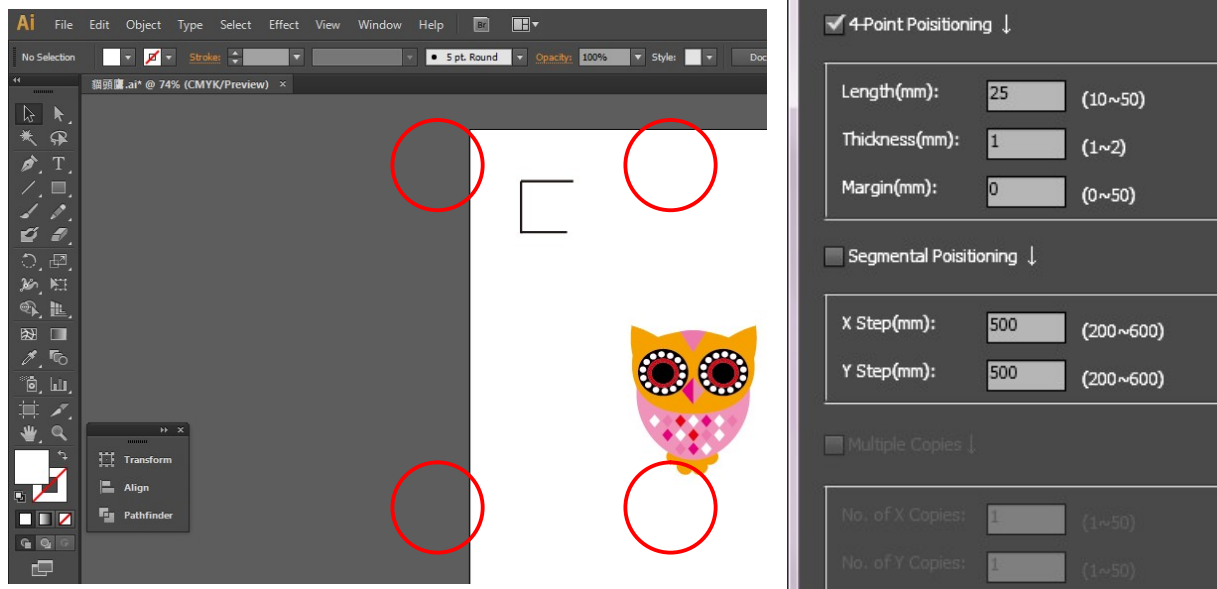

Note:

The length setting will be in the range of 10-50mm according to your page size.

Workable area

It allows users to edit and cut graphics in the area outside the registration marks when adding registration marks by page.

For A4 size media sheet, the workable area is 2.5mm extended from the registration mark on left and right sides and 4.5mm extended from the registration mark on top side. On the bottom side, it is suggested to leave at least 25mm margin from the edge of media sheet to prevent sheets dropping or any error occurred while media sizing.

For A3 size media sheet, the workable area is 10mm extended from the registration mark on the left side, 9mm extended from the registration mark on the right side and 11mm extended from the registration mark on top side. On the bottom side, it is suggested to leave at least 25mm margin from the edge of media sheet to prevent sheets dropping or any error occurred while media sizing.

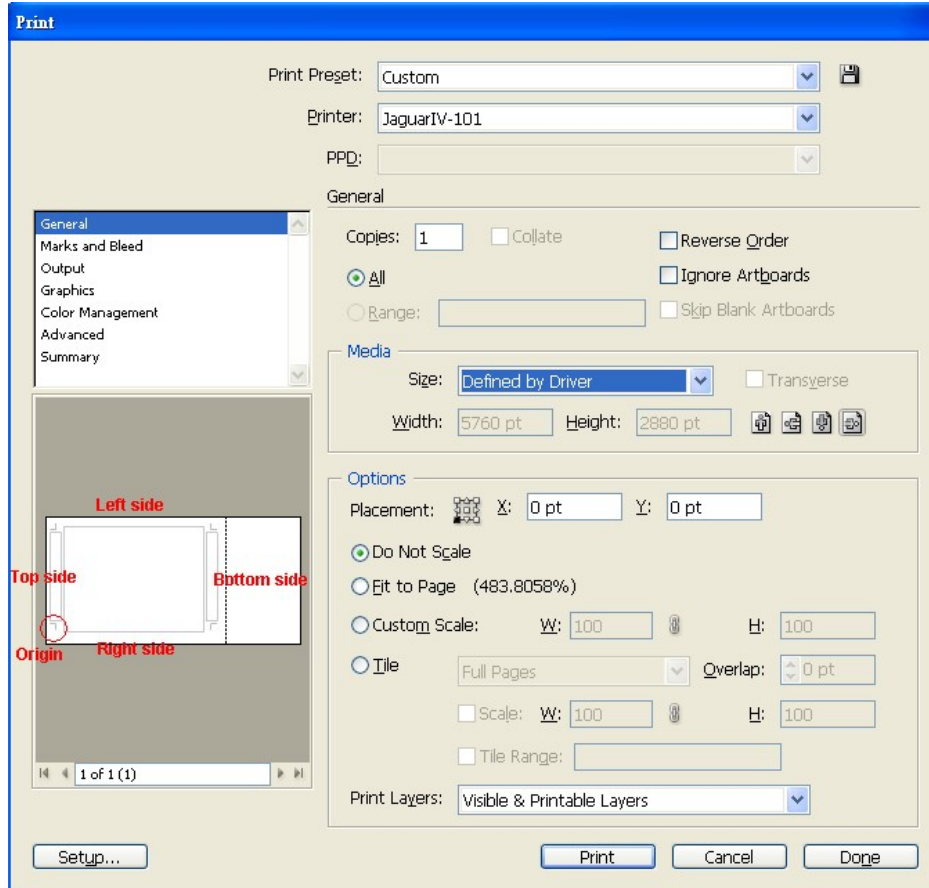

Note: Select “Edge” mode when media sizing to allow the media sheet to be unrolled. If you select “Single” mode, the media sheet will not be able to be moved back and hence fail to be detected by front paper sensor.

Add Registration Mark by Object

If you add registration mark by Object, you will be offered three options of registration marks.

Firstly, select the graphic which you want to add registration mark on and go to “Scripts” under “File” and select “_AASII_Plug_In”.

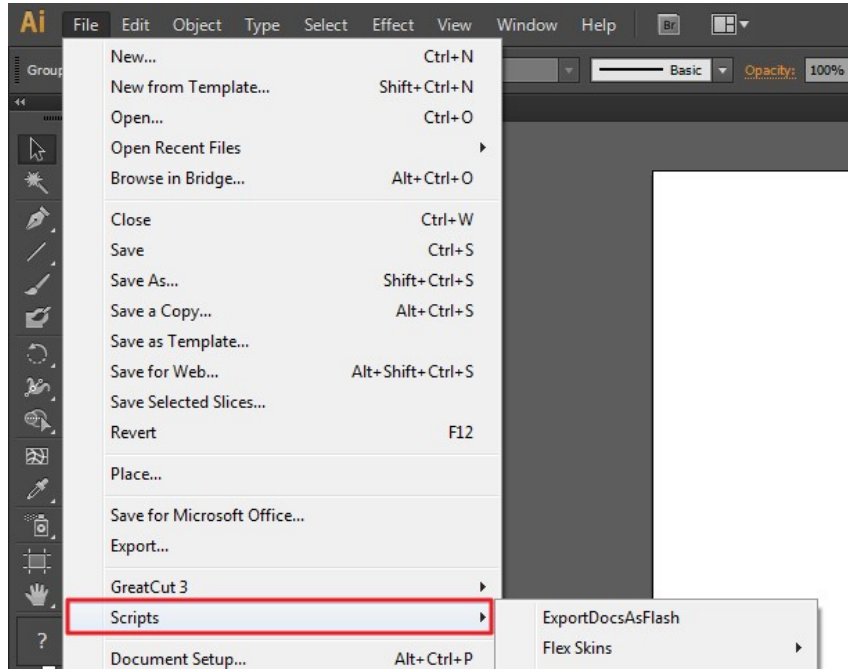

Make sure to untick “Make by page size” and choose one of the registration mark types whichever is suitable.

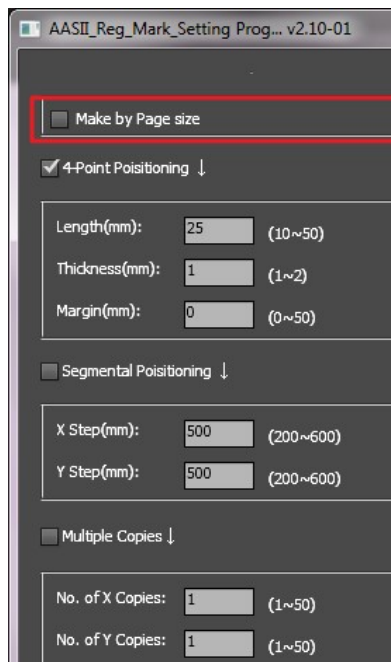

Three types of registration marks

4-Point Positioning

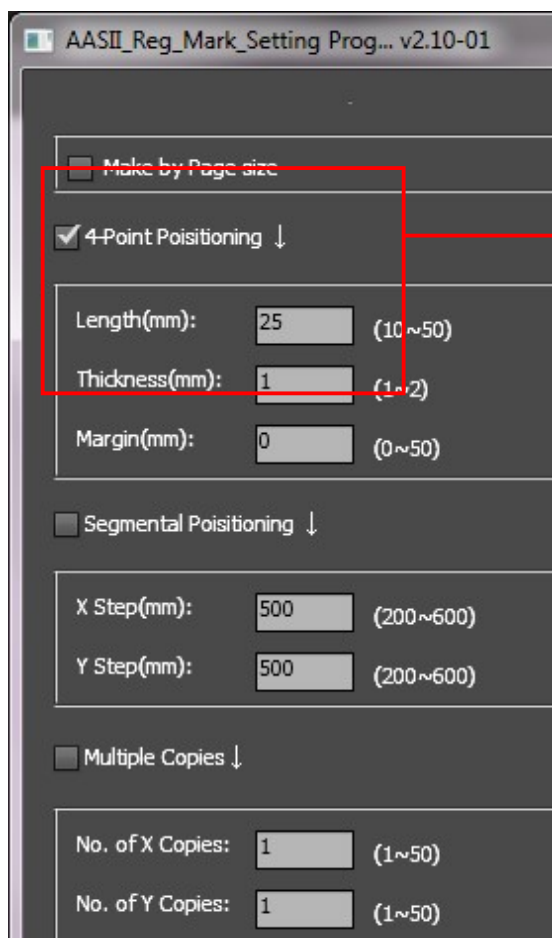

4-Point Positioning

- Length: The length of marks
→ Range: 5mm~50mm
→ Optimized Setting: 25mm
- Thickness: The line thickness of marks
→ Range: 1mm~2mm
→ Optimized Setting: 1mm
- Margin: The distance between marks and images
→ Range: 0mm~50mm
→ Optimized Setting: 5mm

The system will create the 4 marks as shown in the picture below.

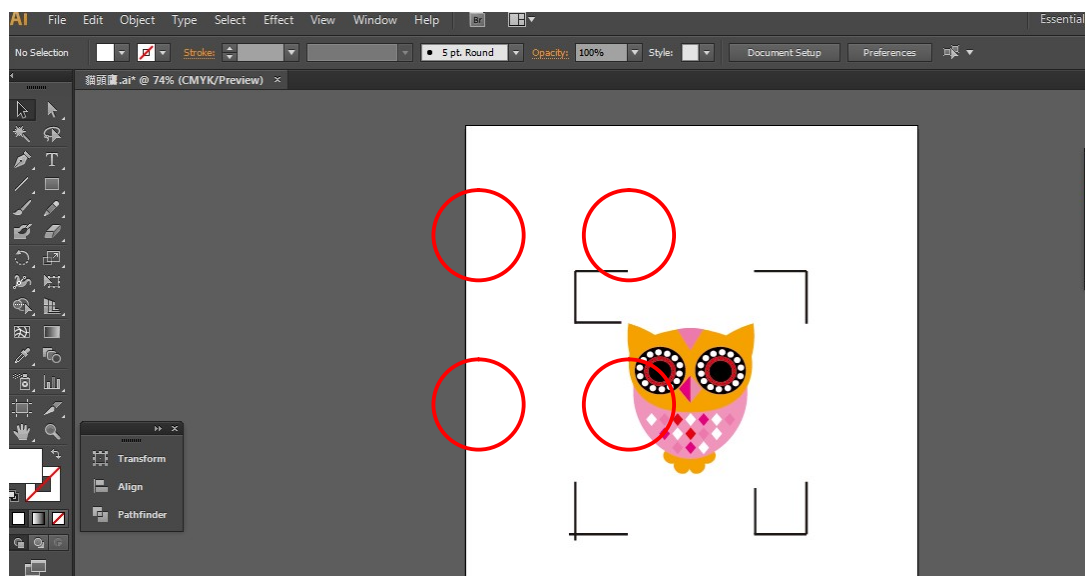

Note:

1. To save your materials, in addition to amending object margins, you can also adjust the length of the registration marks (5mm minimum) when you apply 4-Point Positioning (see table 1 for suggestions based on different material sizes). The smaller the size is, the smaller the distance between the object and the registration marks is (see the figures below).

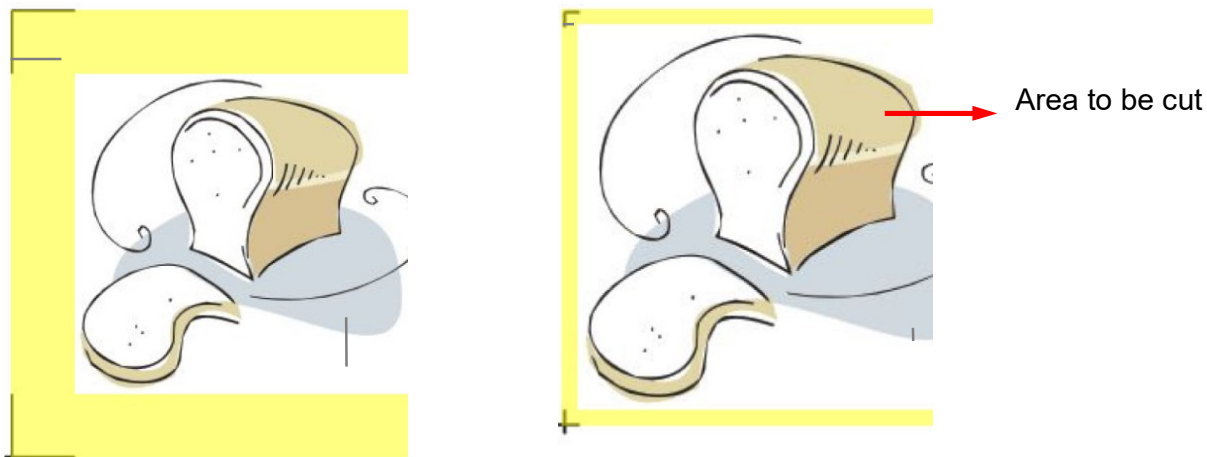

Page size (unit: mm)	Suggested mark length (unit: mm)
A6 (105 x 148)	5
A5 (148 x 210)	8
A4 (210 x 297)	11
A3 (297 x 420)	16
A2 (420 x 594)	23
A1 (594 x 841) and above	25*

Table 1

*25mm is the suggested value for the registration mark length

2. The size of the registration marks would affect the accuracy of registration mark detection so please make sure the amount you enter is reasonable.
3. If you change the paper size, you will have to reset the registration marks otherwise the previous setting will be applied.

Segmental Positioning

For precise cutting quality, it is suggested to select “Segmental Positioning” when you are working on an extra long or large-sized image to increase cutting accuracy.

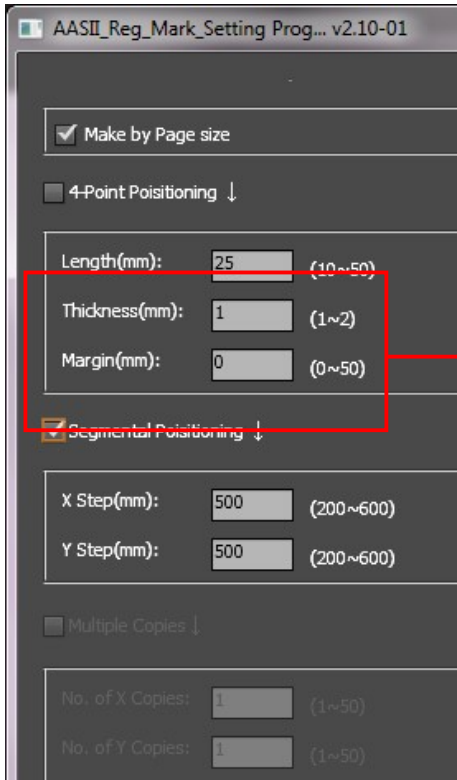

Segmental Positioning

- X Step: The distance of intermediate position on the X axis
- Y Step: The distance of intermediate position on the Y axis
 - Range: 200mm~600mm
 - Optimized Setting: Less than 500mm

The system will create the marks as shown in the picture below.

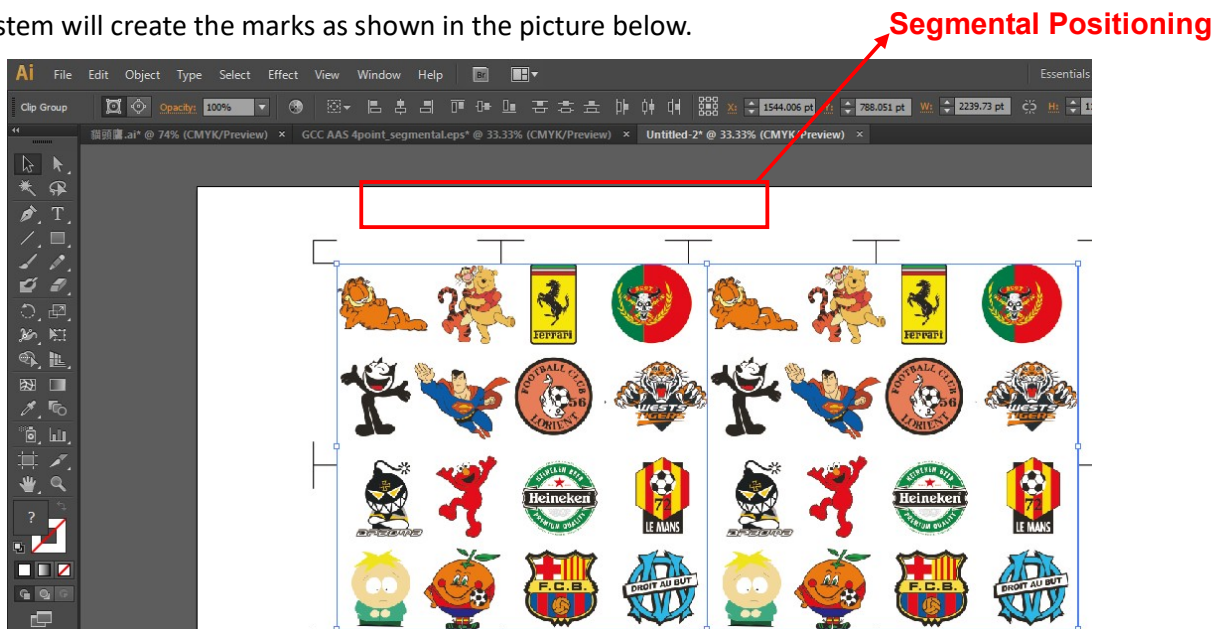

Multiple Copies

It is suggested to select “Multiple Copies” when you would like to make several copies of one image on your material to increase cutting accuracy.

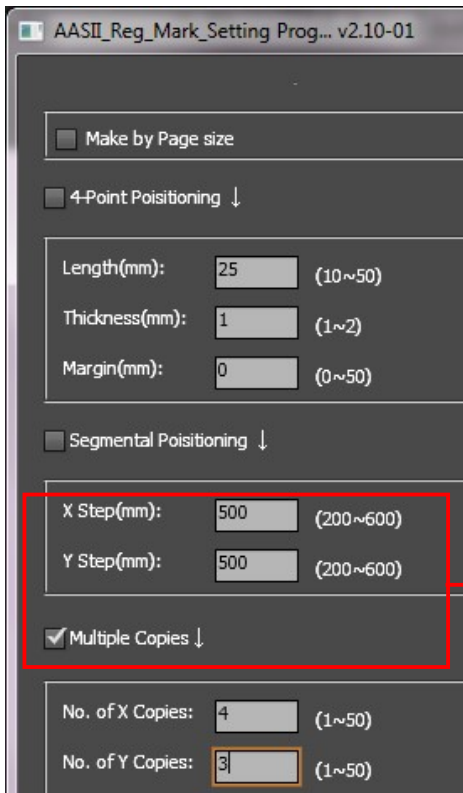

Multiple Copies

- No. of X Copies: The numbers of copies on X axis
- No. of Y Copies: The numbers of copies on Y axis
→ Range: 1~50. (The more copies you make, the more time is needed for data transmission.)
→ Numbers of X Copies * Numbers of Y Copies = The total amount of image copies
- Copies with outline : To show outlines of image graphics
- Margin: Space between marks; must be 0 or ≥ 20 , no negative numbers allowed

The system will create the as shown in the picture below.

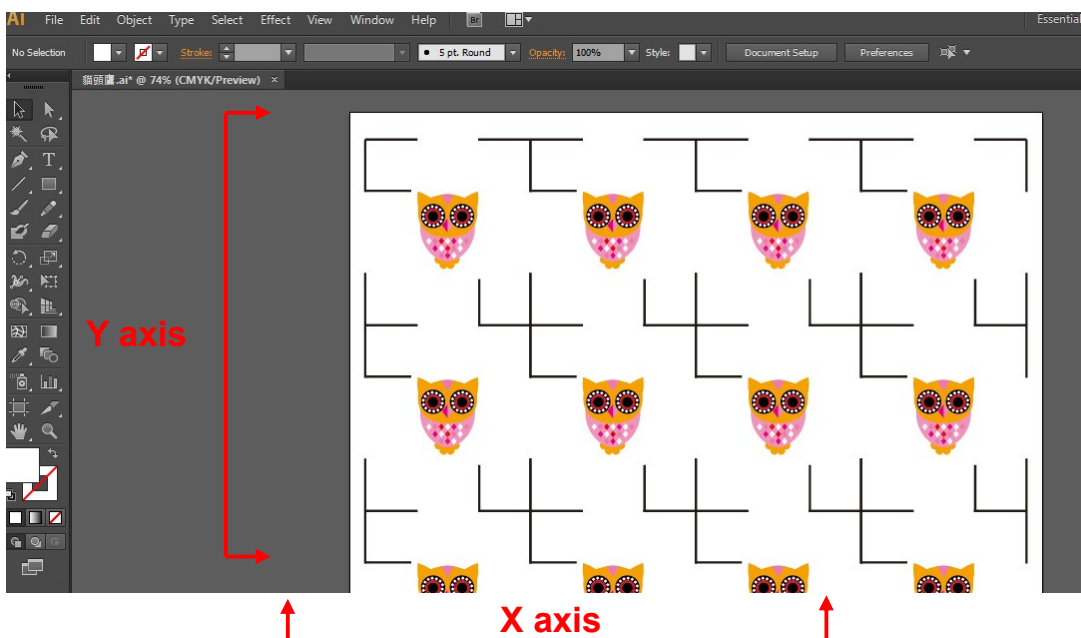

GreatCut-S

There are basic instructions of GreatCut-S below. If you need detailed instruction, please refer to GreatCut-S Help.

A. Select the cutter you want to output and change the work area.

1. Run GreatCut-S software.

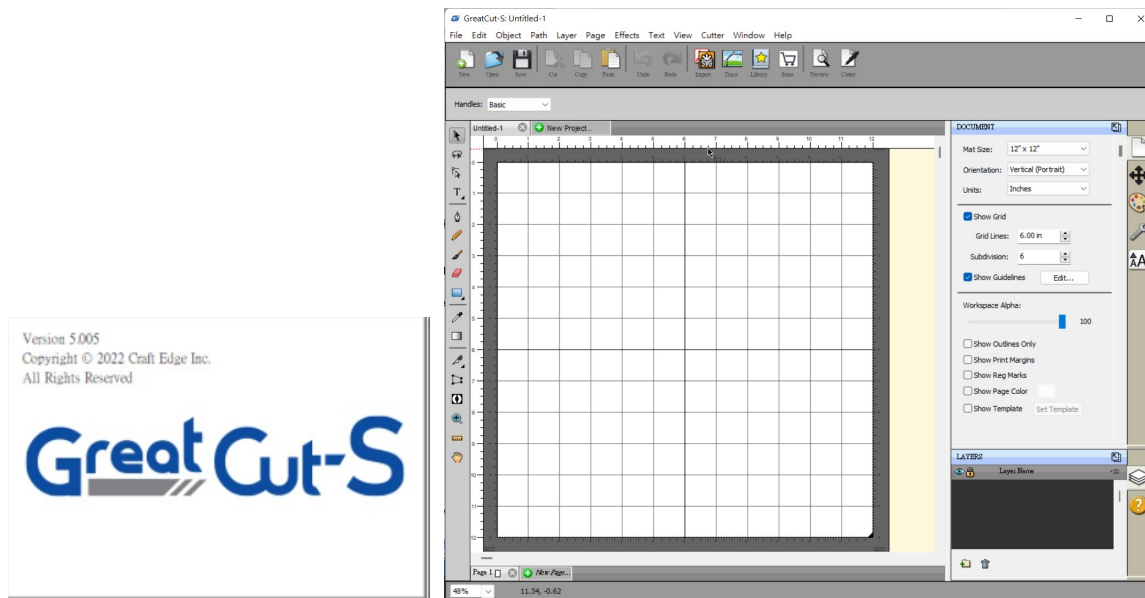

2. Select "Cutter" and select "Manage Cutters" under My Cutter to change the work area.

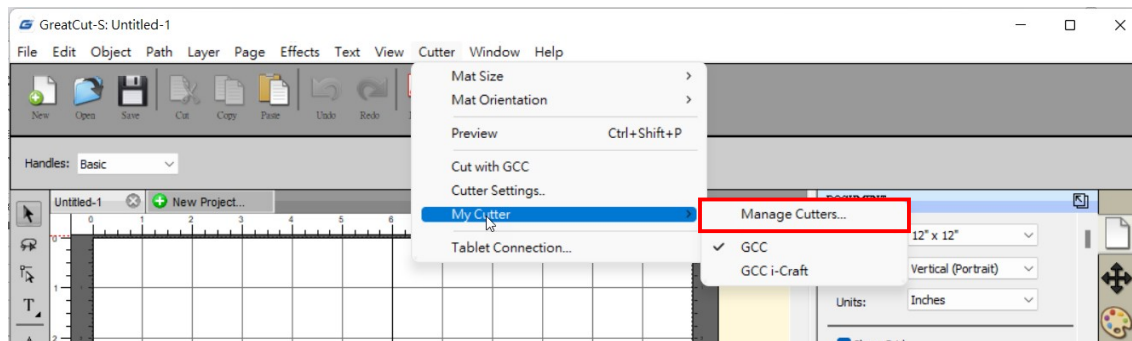

3. Select company / brand as GCC and select model you want to output and then click the “<--Add to list” button.

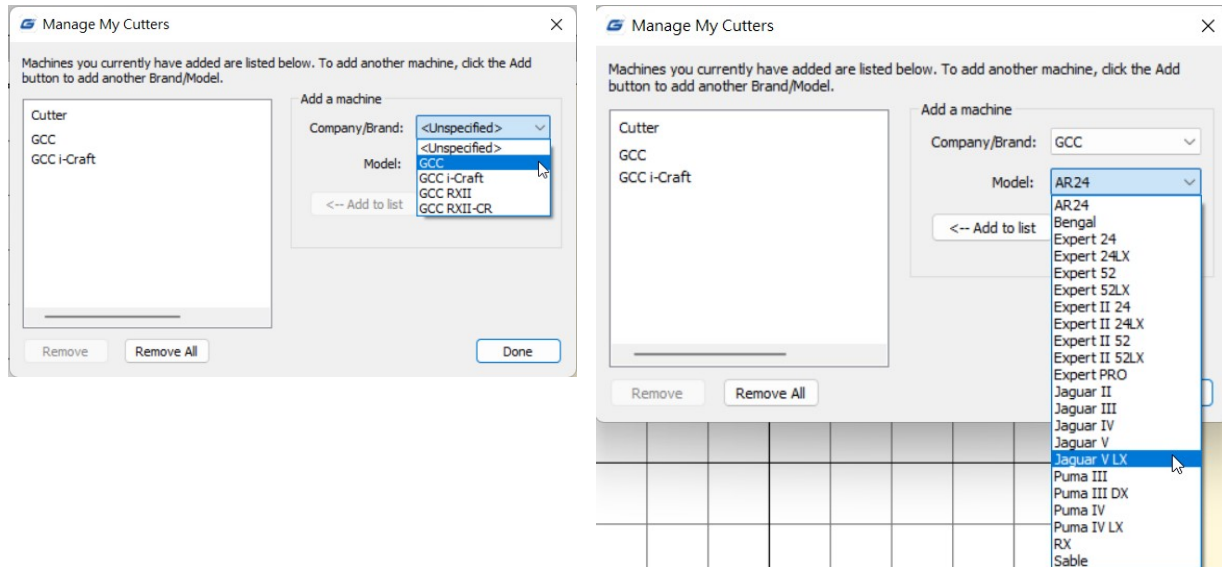

4. Select GCC on the left and click “Done.”

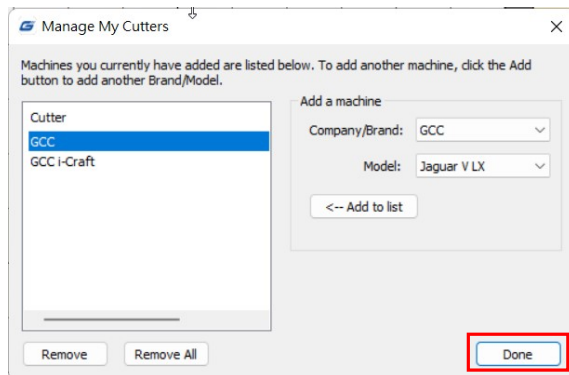

5. If you want to change the material size and orientation, you can fill a proper value in the Document window.

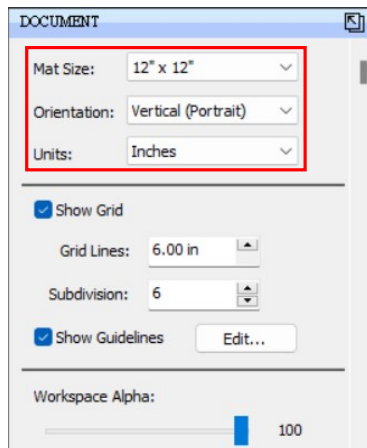

B. Insert Graphics from Library

Select graphics from library to insert a selected design.

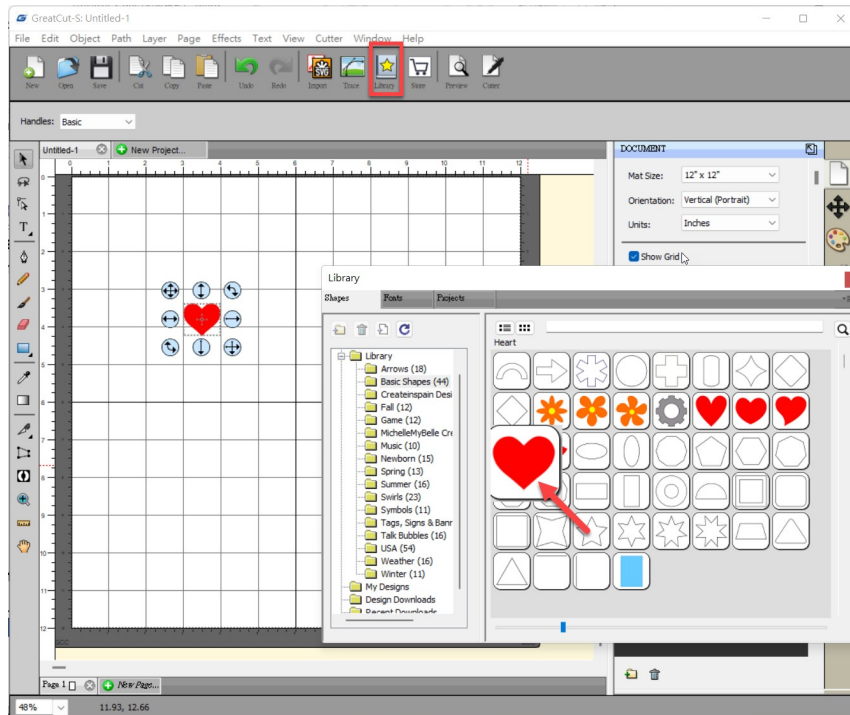

C. Draw Text

Click on the T icon at left side to create the text and select the font you like at text window.

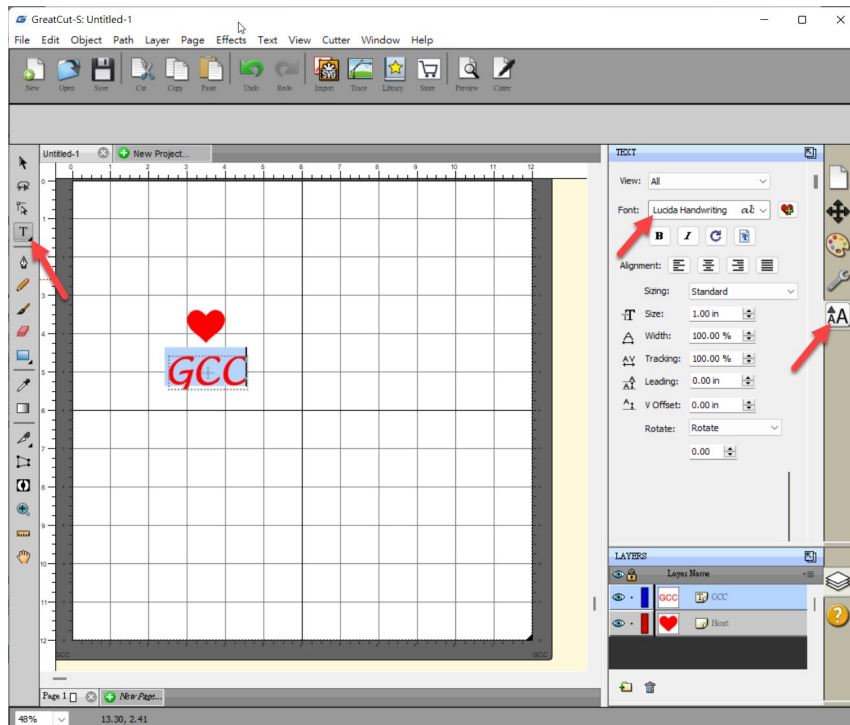

D. Import Design

If you have created your design in other design software, go to “import” or “place image” under file to import it, GreatCut-S supports svg, scut, scal, pdf, ai, wpc eps, bmp, gif, jpg and png files.

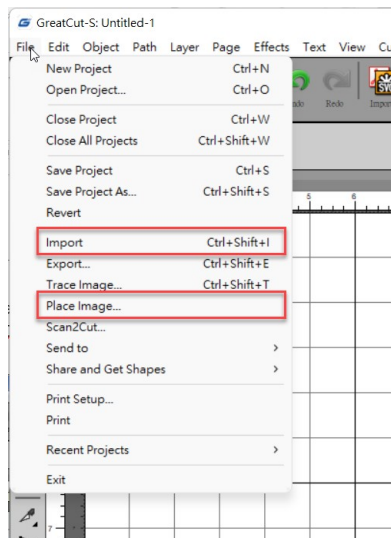

Tips Thousands of SVG files available on SVGcuts!

- ✓ <http://SVGcuts.com> is the top of source for designer SVG files. Thousands of high quality elements including: shapes for card-making, scrapbooking, as well as gift bags, boxes and 3D flowers.

E. Convert Image to Cutting File

1. Go to Trace Image under File, or select Trace Image icon on the toolbar to open the setting window.

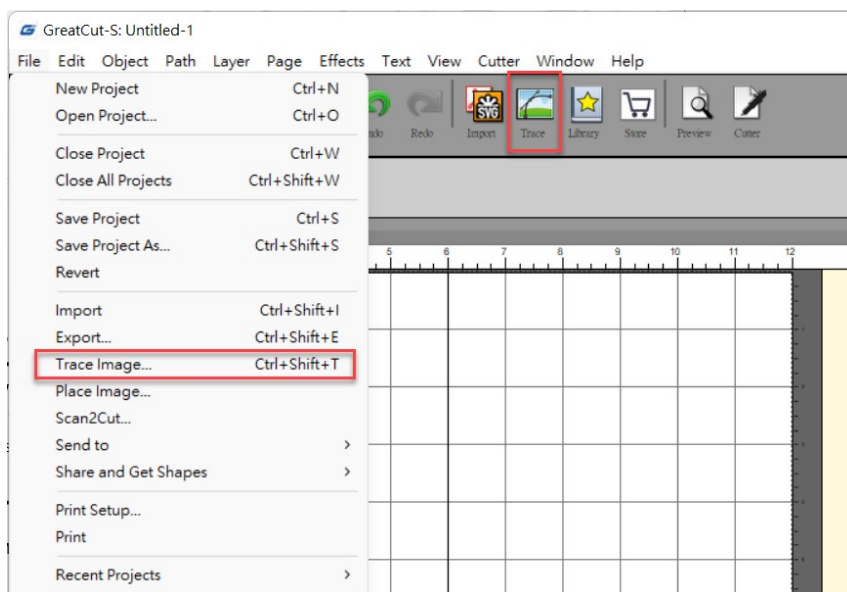

2. Click on “Choose an image” to input the image, adjust Image Settings and Output Settings, and click OK. Then the outline of the image will be outputted automatically.

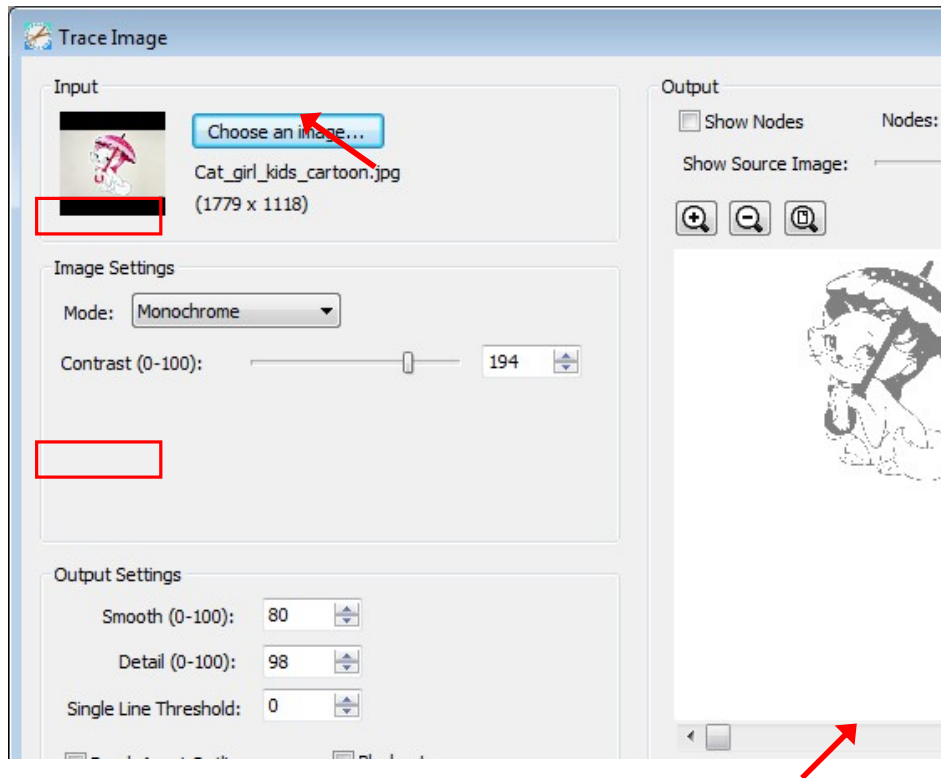
**Note**

- ✓ The **contrast** and **pixels** of import images will affect the trace image result. High contract graphics are recommended.

F. Cut the Design

1. Click on the “Cutter” button on the toolbar and Cut Settings window will pop up.

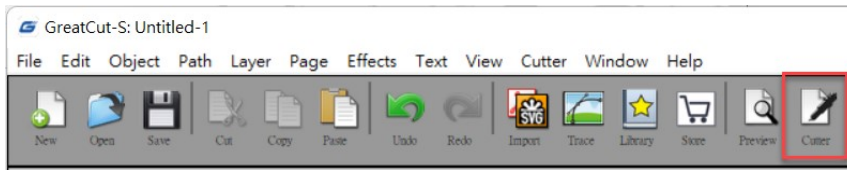

2. Click on “Settings...” to open GCC Cutter Settings window.

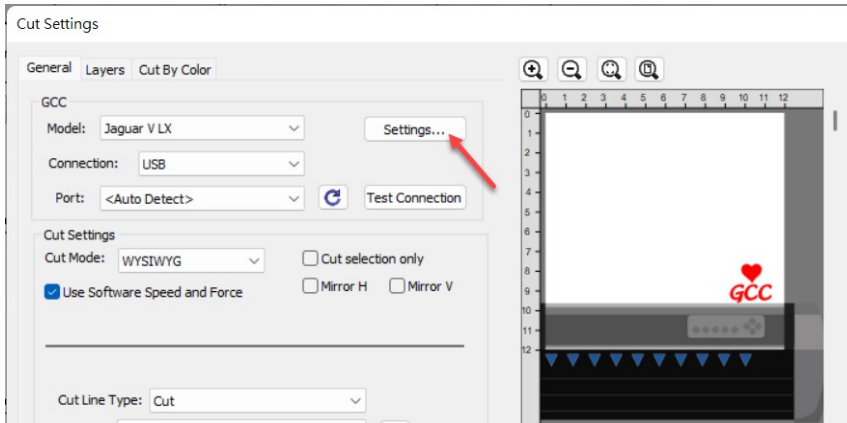

Note

- ✓ The origin point is on the bottom right.

3. Adjust Registration Marks setting under GCC Cutter Settings window if needed.

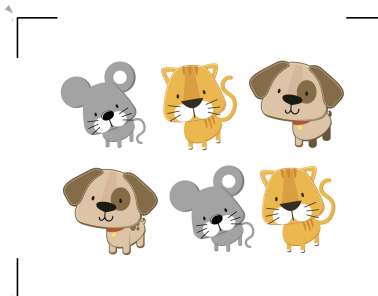
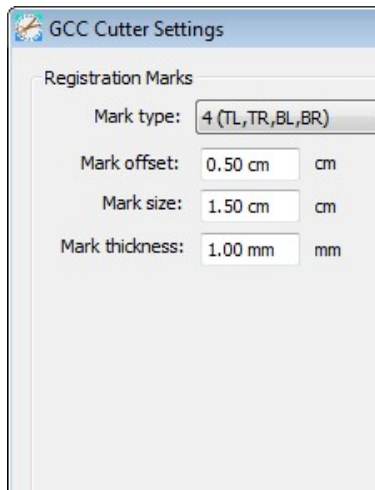

***Registration Marks:** set the distance between the edge of the material and the registration marks in Mark Offset; set the size of marks in Mark Size; set the line thickness of marks in Mark Thickness.

4. Adjust Blade Offset, Overcut Value, Multi-Cut and Quality under Cut Settings window if needed.

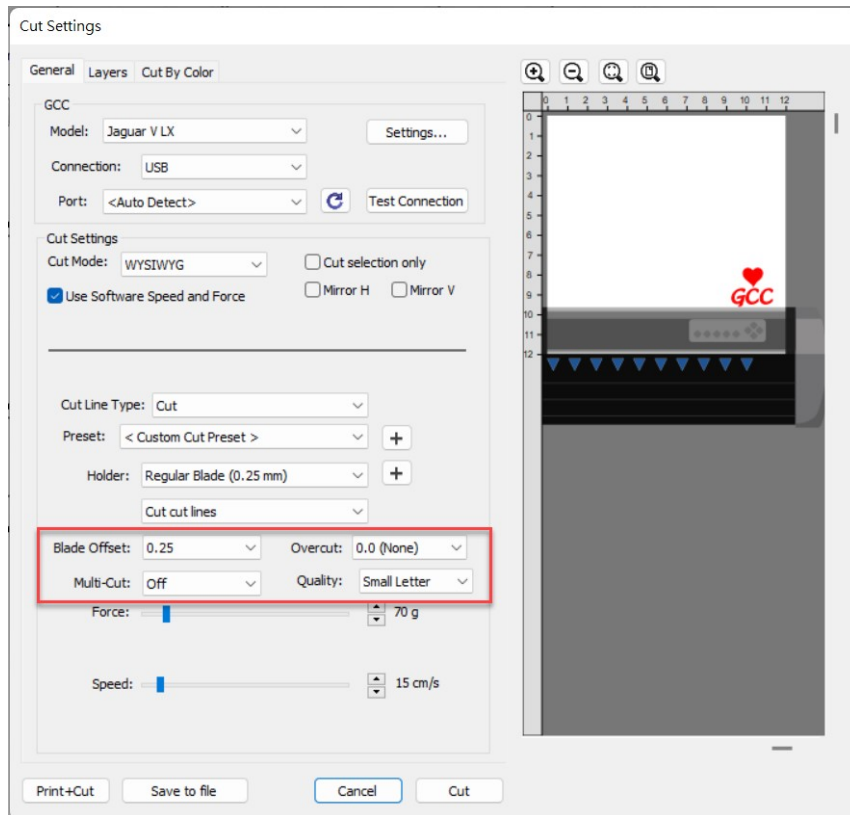

***Blade Offset**: set the offset value according to different blade, for a standard blade, set the offset value at 0.25mm, 0.5mm for an optional advanced blade and 0mm for an optional plotting pen.

***Quality**: associated with the cutting result; please note the better cutting quality, the slower cutting speed.

***Multi-Cut**: to repeat the cutting job at same position which is suitable for cutting thick material.

***Overcut**: allows for easier weeding and makes up for incomplete cut lines.

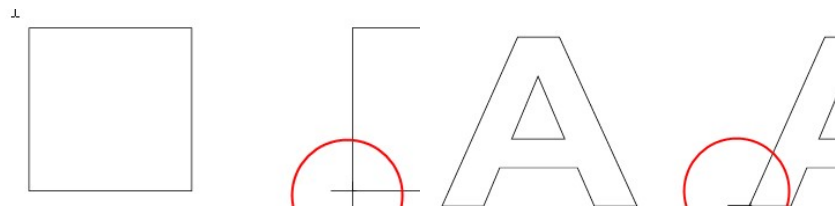

5. Under “Cut Settings” section, there are some useful functions. After setting the parameters, click on “Cut” to send the data to the GCC cutter and the GCC cutter will start the cutting job.

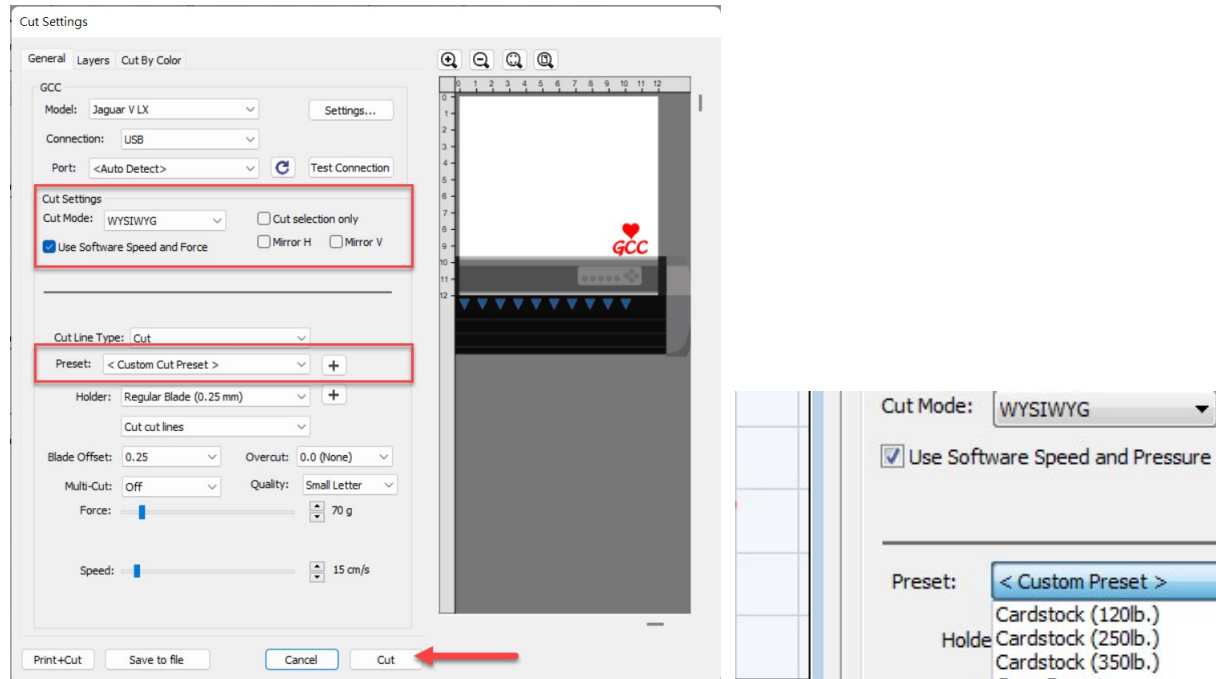

***Cut Mode:** there are “WYSIWYG” and “Origin Point” options, WYSIWYG means what you see is what you get, the cutter will output the graphic at same position in preview window. While with Origin Point mode, the cutter will cut the graphic from bottom right origin point of the material.

***Use Software Speed and Pressure:** tick this section, and you can set the values of speed and pressure manually.

***Preset:** select a proper material to apply the preset speed and pressure parameter automatically.

***Speed & Pressure:** you may adjust values of speed and pressure manually to get quality results.

G. Print and Cut Your Design

The Print and Cut function allows you to print the graphics from GreatCut-S to printer, and then put the printed materials on the GCC cutter to cut out the contour of printed jobs from GreatCut-S.

1. Open an image file in GreatCut-S.

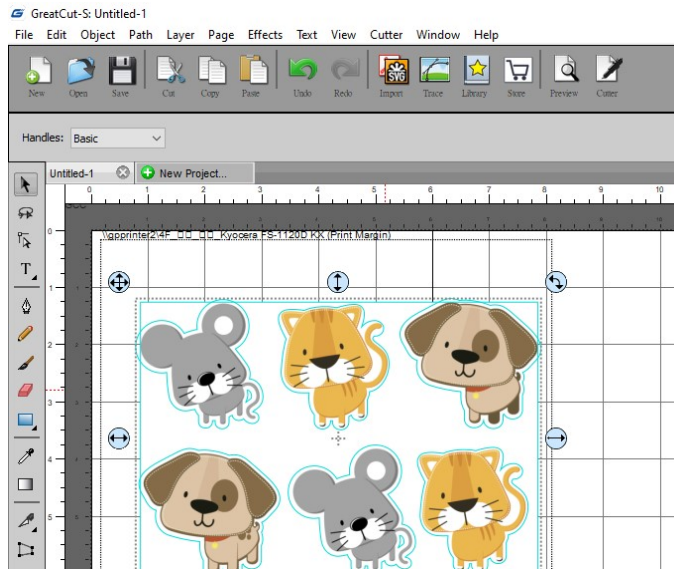

2. Click on the Cutter icon on the toolbar, set the parameters and click on “Print+Cut” to add the registration marks and print out the image.

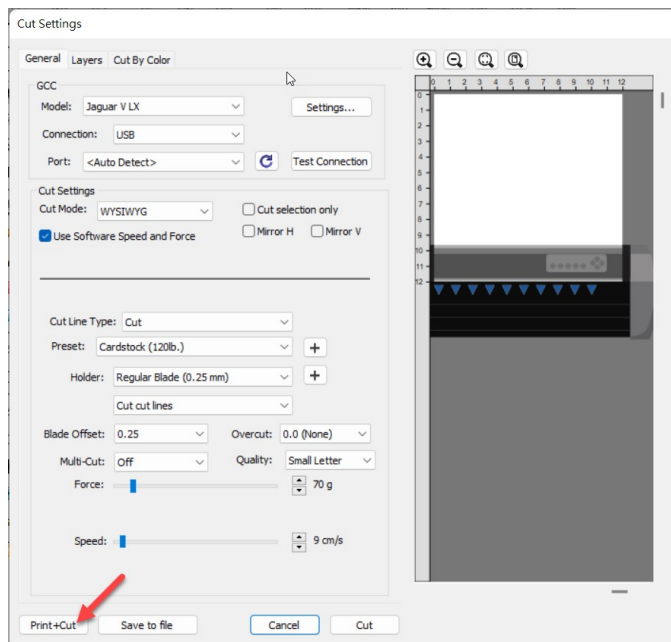

3. Click on “Print...” to open printer setting window and click OK.

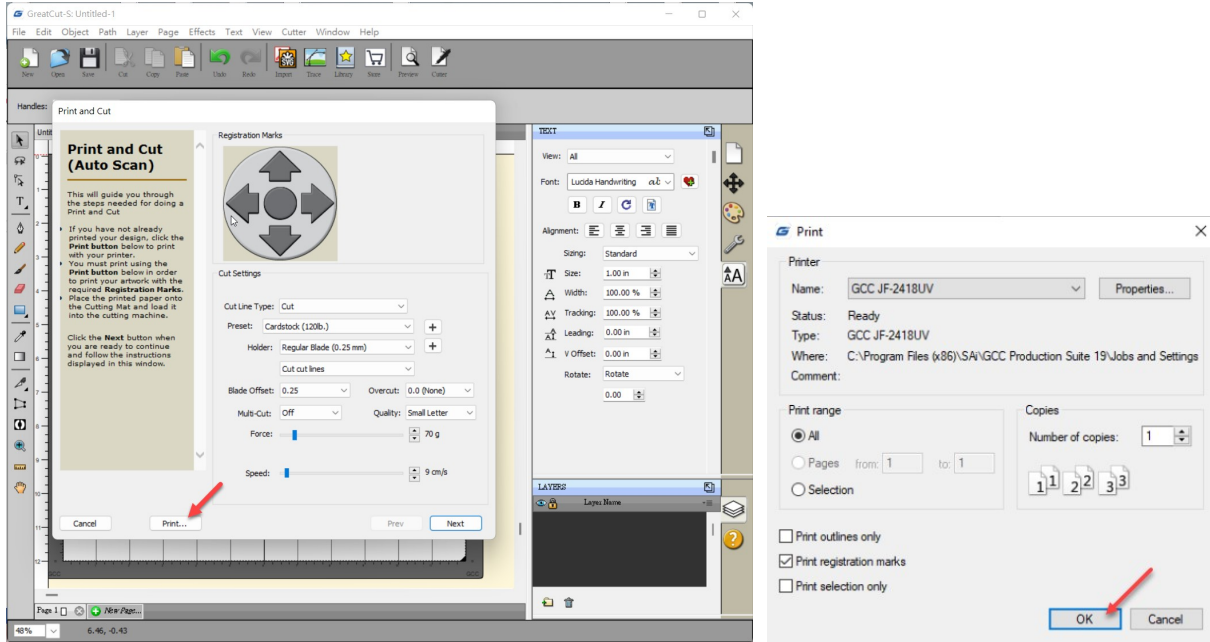

4. Print your design with registration marks out.

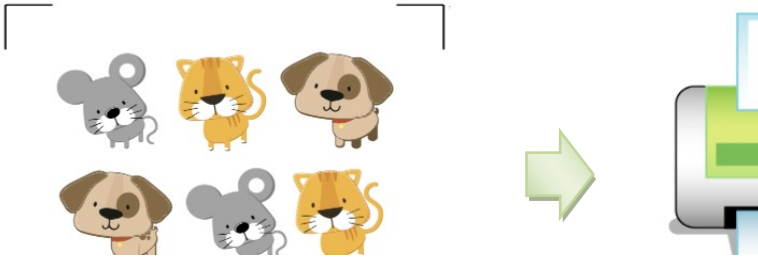

5. Load the printed media to the GCC cutter.

6. Press “Next” and then press “Scan+Cut”, and then the GCC cutter will detect the registration marks and cut the contour lines automatically.

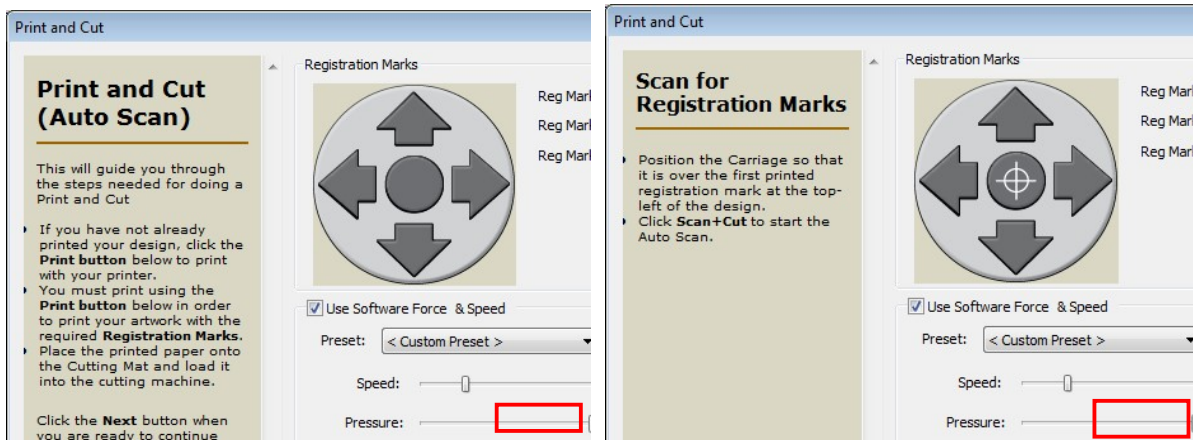

Tips Test Connection function can save your materials.

✓ Click on “Test Connection” to exam if set the connection properly.

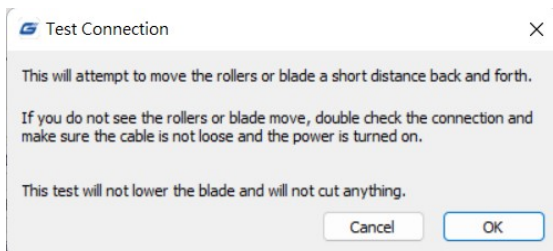
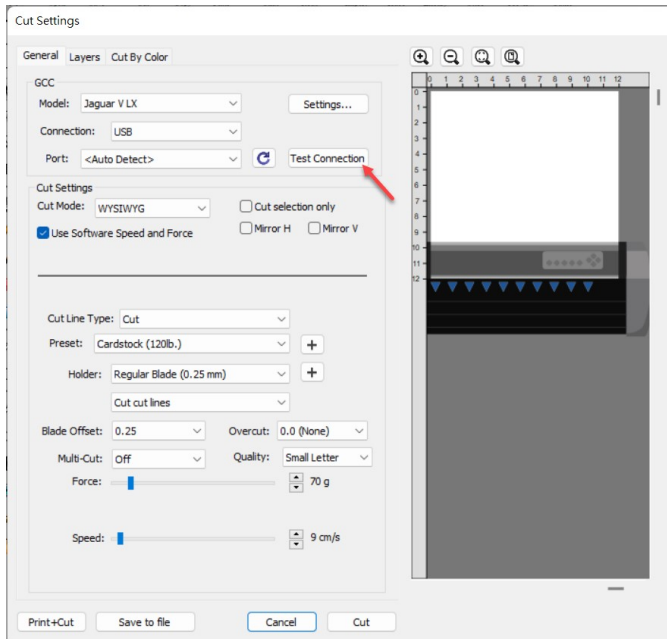

H. Cut by Color

The Cut by Color function allows you to choose which colors in your design you want to cut, and designate different parameters to each color. You can cut your designs in a single job or separate jobs for each color.

1. Select a design and specify a color for it.

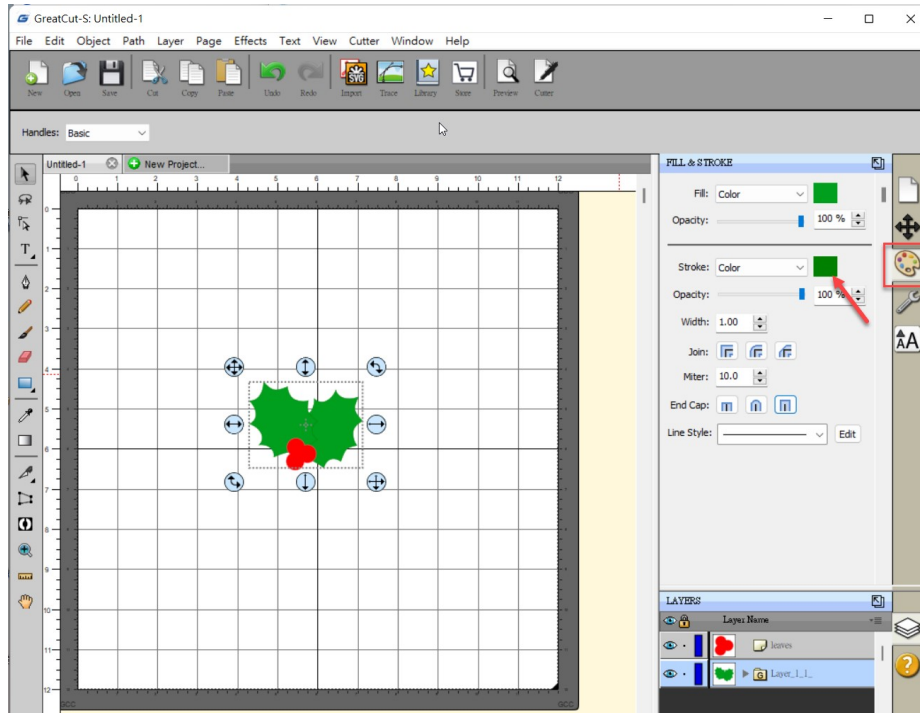

Then define cut type and parameter.

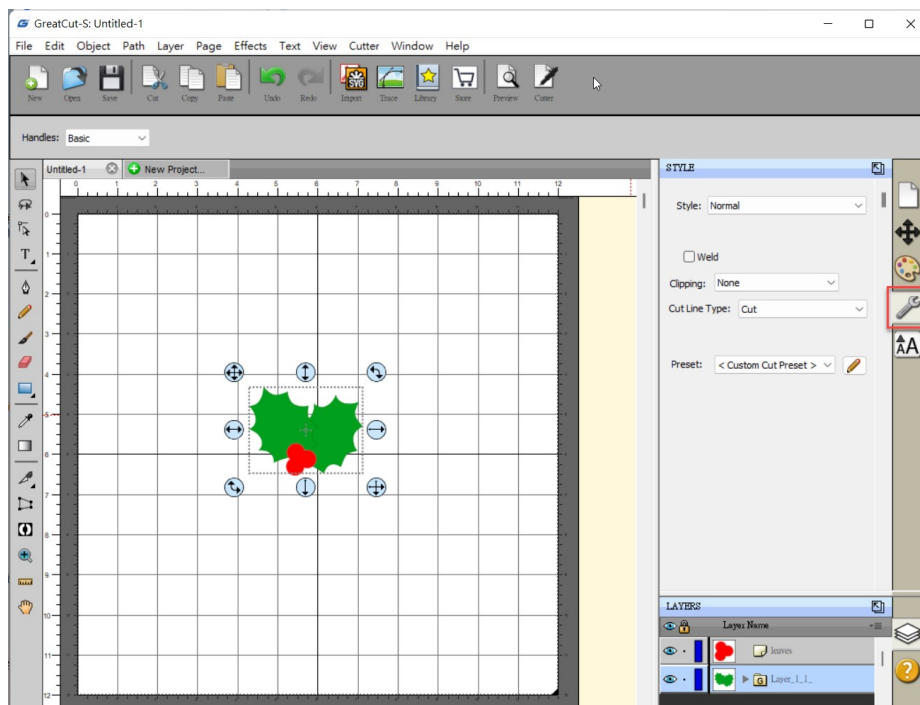

2. Click on “Cut” to open Cut Settings window.

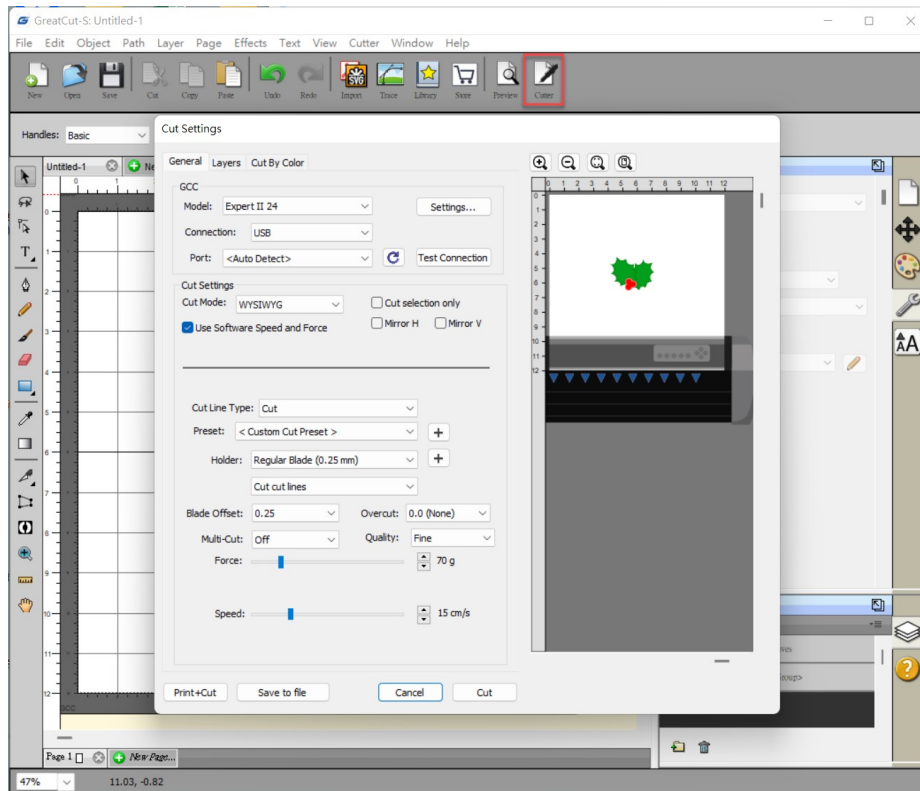

3. Click on the Cut by Color tab and choose to either Cut all Colors in a single job or Cut each color separately as an individual job.

When Cut each color separately is selected, GreatCut-S will prompt you between each color before starting to cut so you can load the appropriate color or corresponding tool into your cutting machine.

Note: If the same tool is being used for all colors in a cutting job, it is suggested to use “Cut all colors (Single job)” .

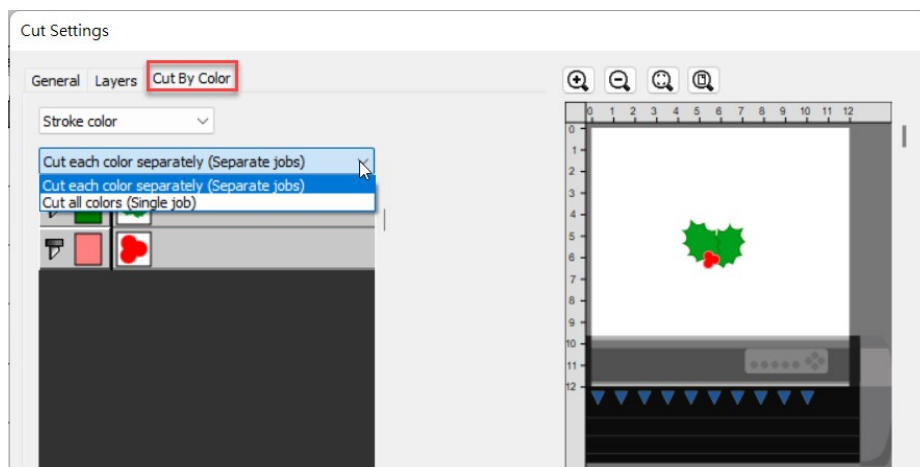

- Click on the blade icon to choose the colors you want to cut. The preview will display which colors are currently enabled for cutting.

Note: You can adjust the order of the layer arrangement by clicking and dragging the layer.

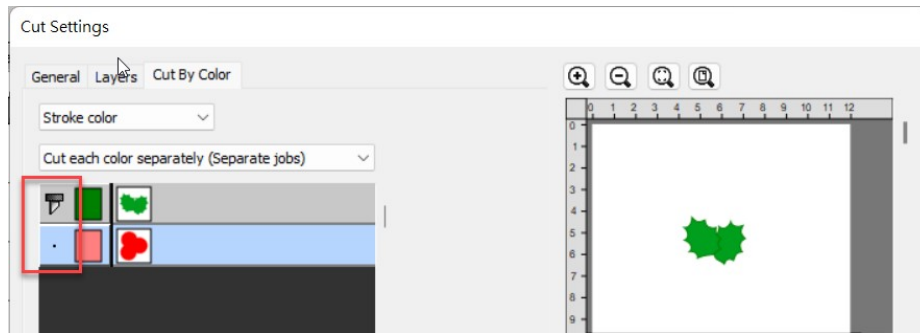
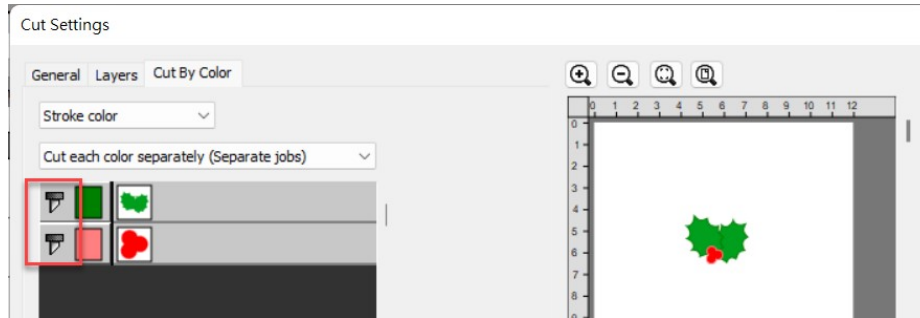

- Click on "Cut" to start cutting.

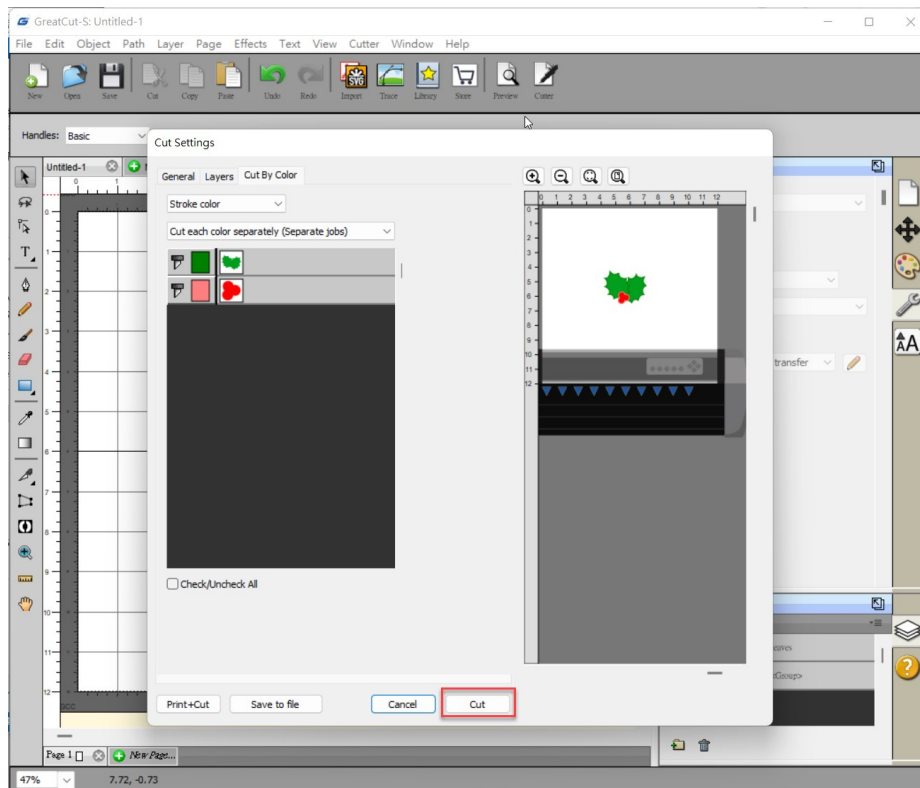

I. How to create Registration mark in Greatcut-S for contour cutting

Step1 Create a file

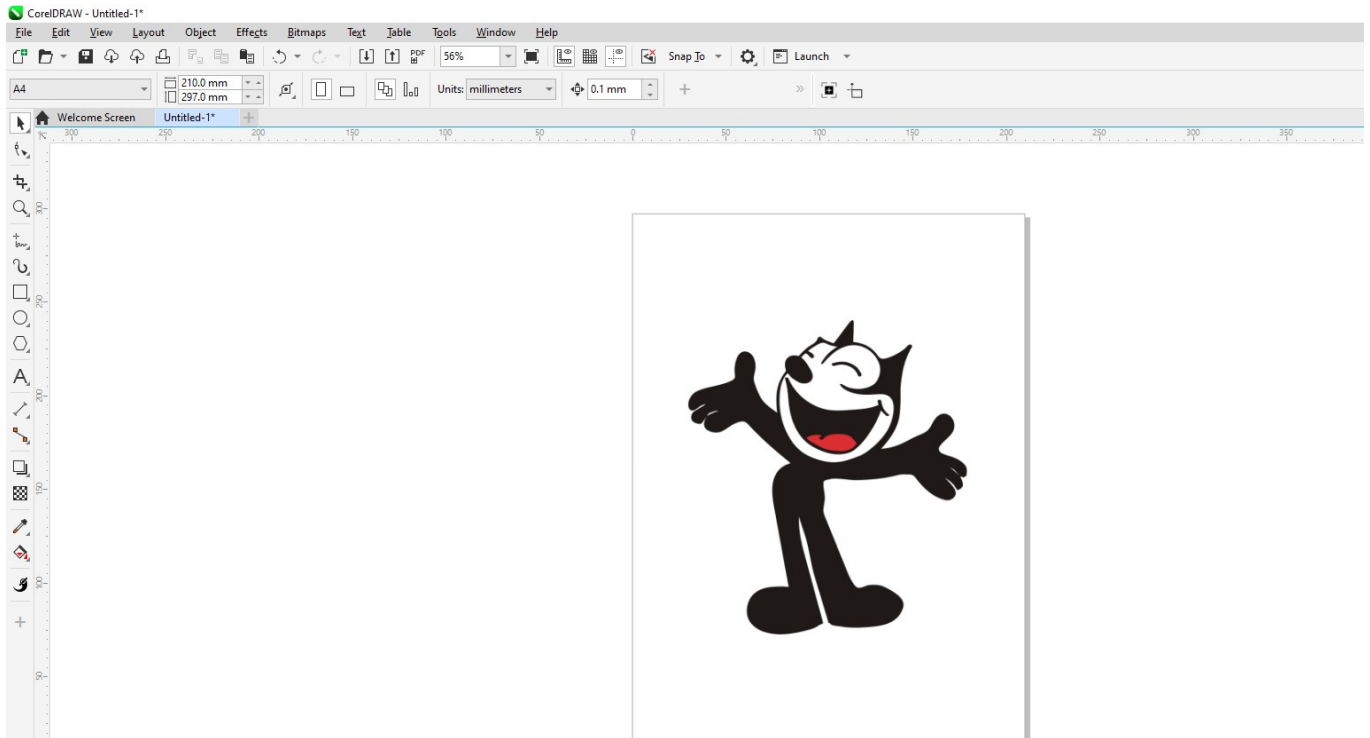

Step2 Go to Windows → Dockers → GteatCut-S Bridge

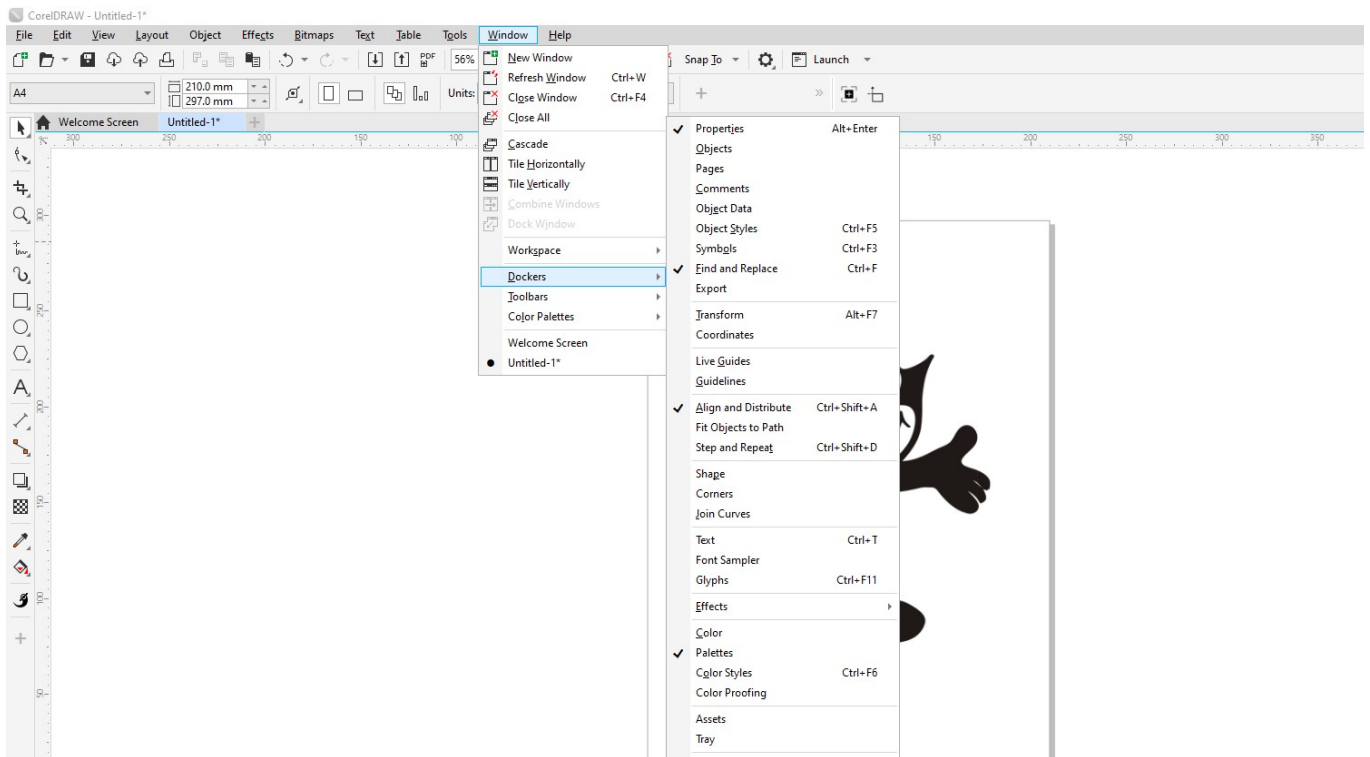

Step3 Select the model with AAS function from the model menu in GreatCut-S Bridge.

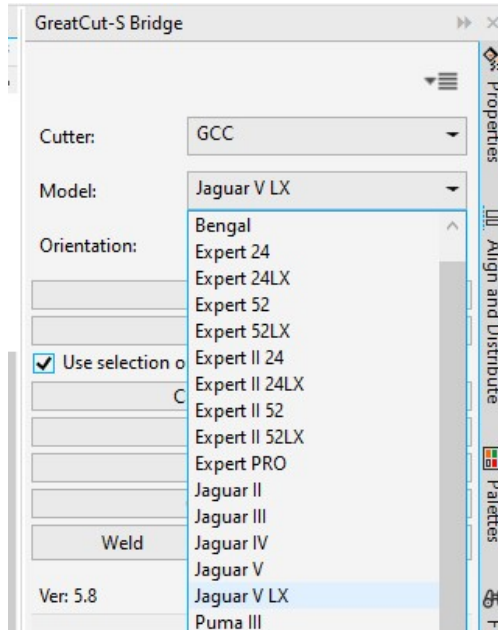

Step4 Select Contour Outline, and define the offset value of contour line from the size option in Shadow Layer menu.

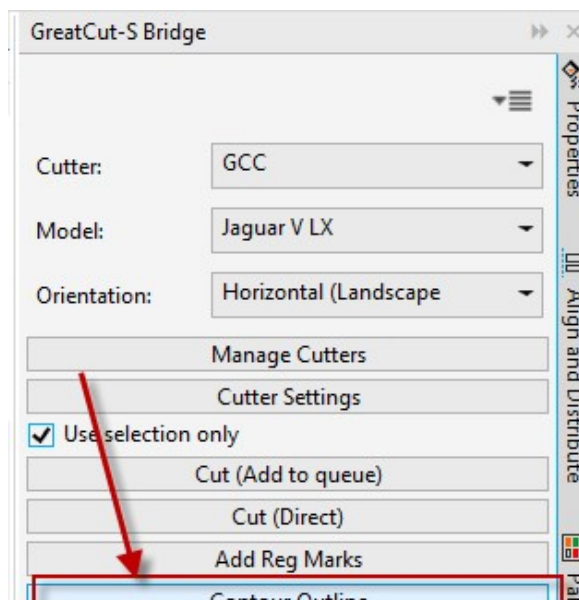

Shadow Layer

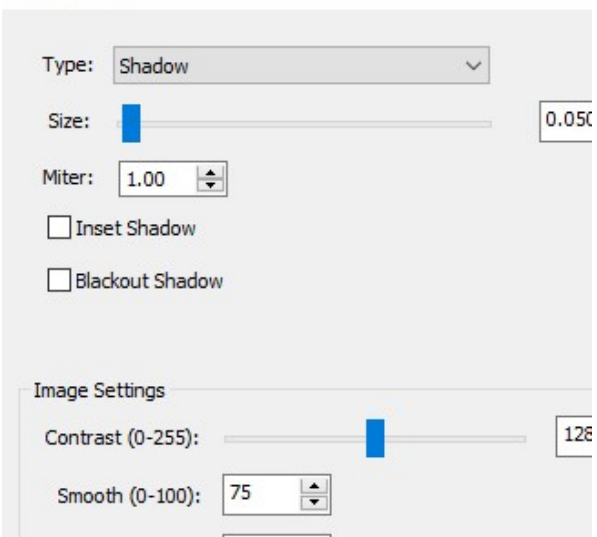

Step5 The contour line is created.

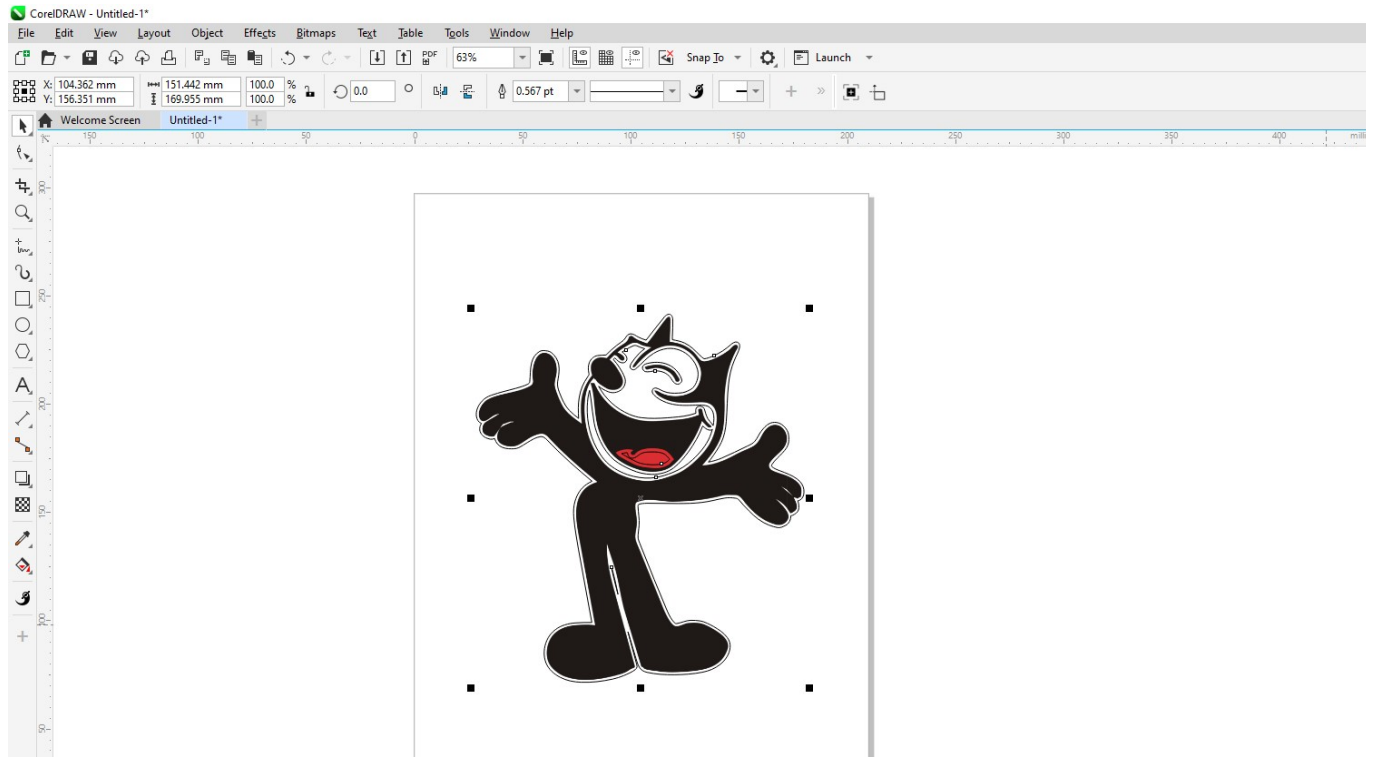

Step6 Select "Add Reg Marks" to add registration marks.

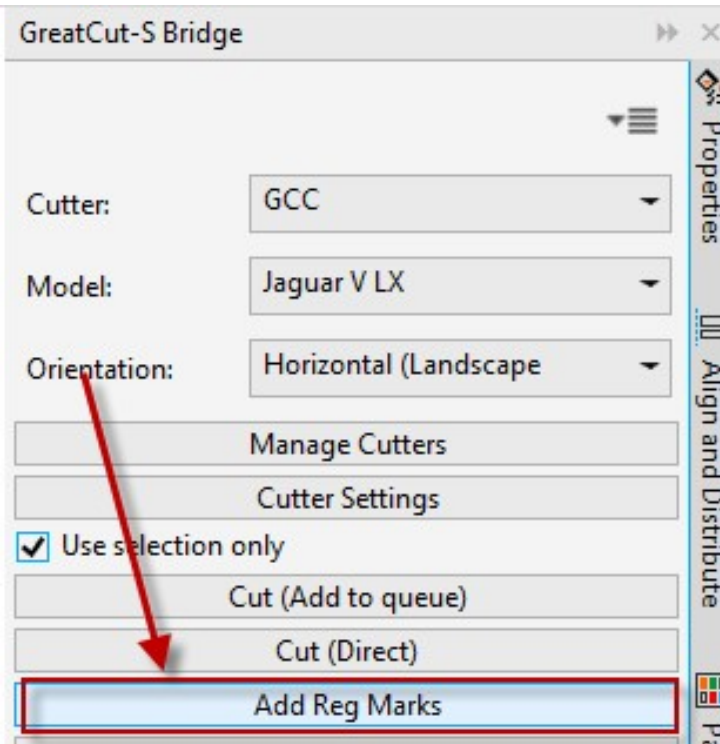

Step7 The registration marks are added.

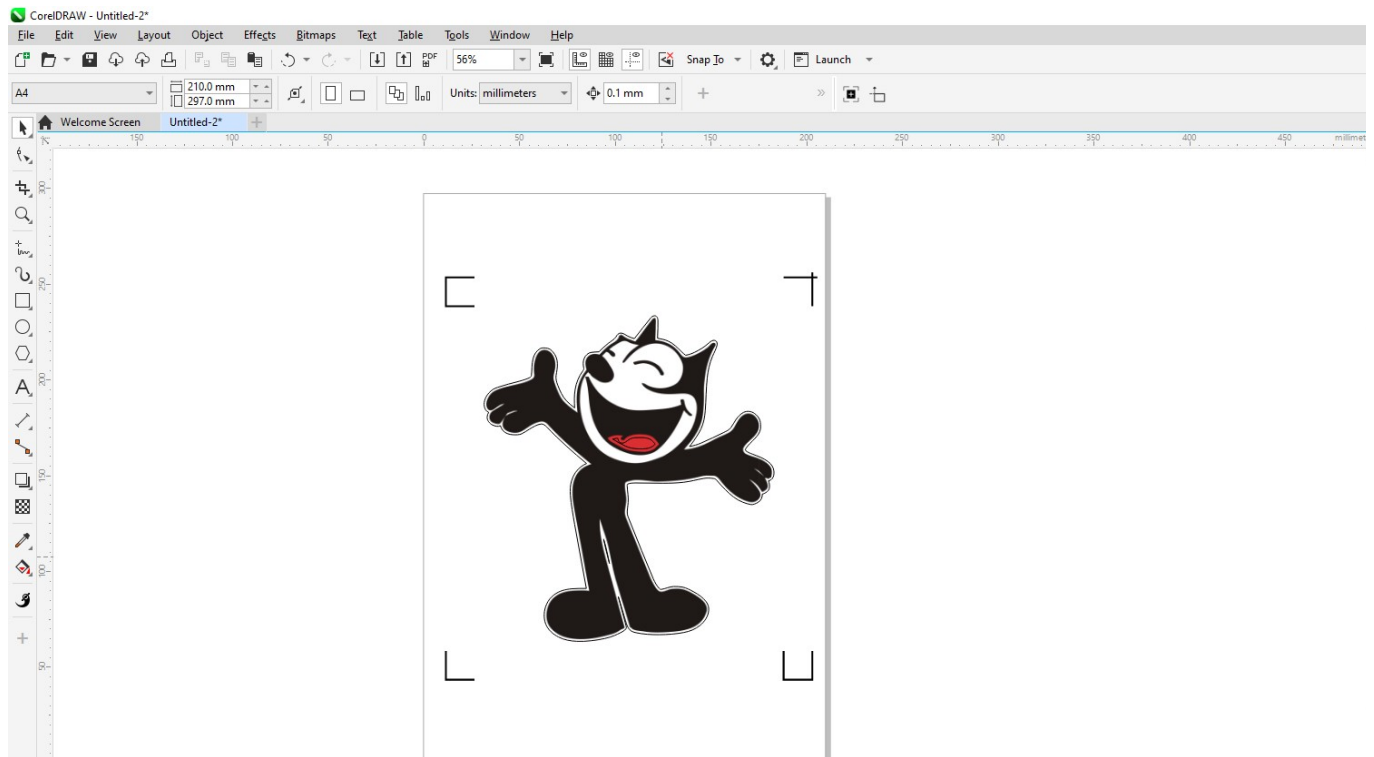

Step8 Select "Cut (Add to queue)" to send the file.

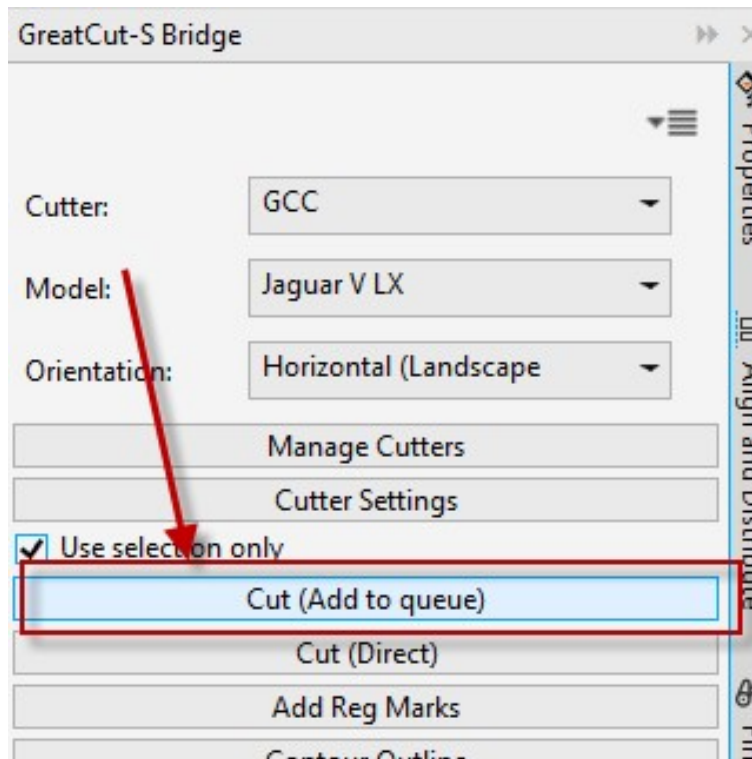

Step9 Click on “Cut” in GteatCut-S Bridge window.

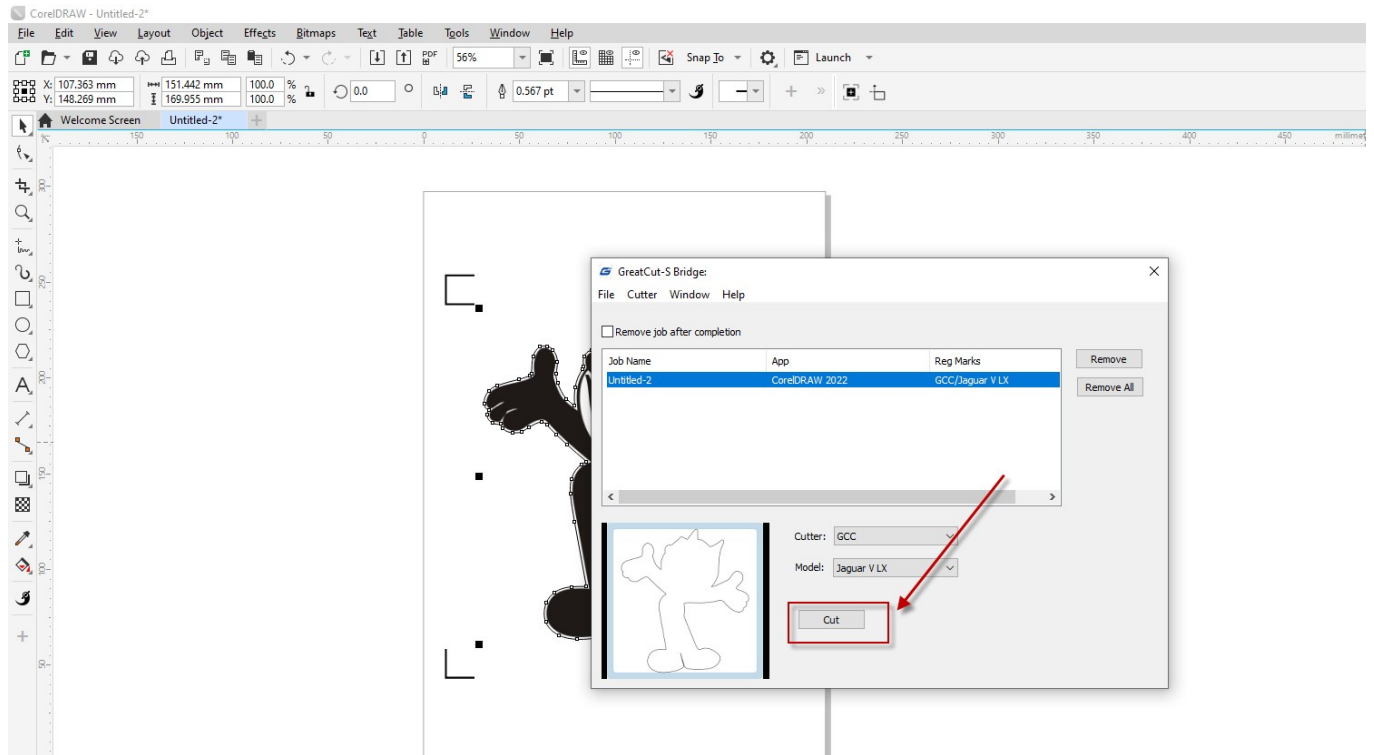

Step10 Define the parameters in Cut Settings window and select “Cut”.

Cut Settings

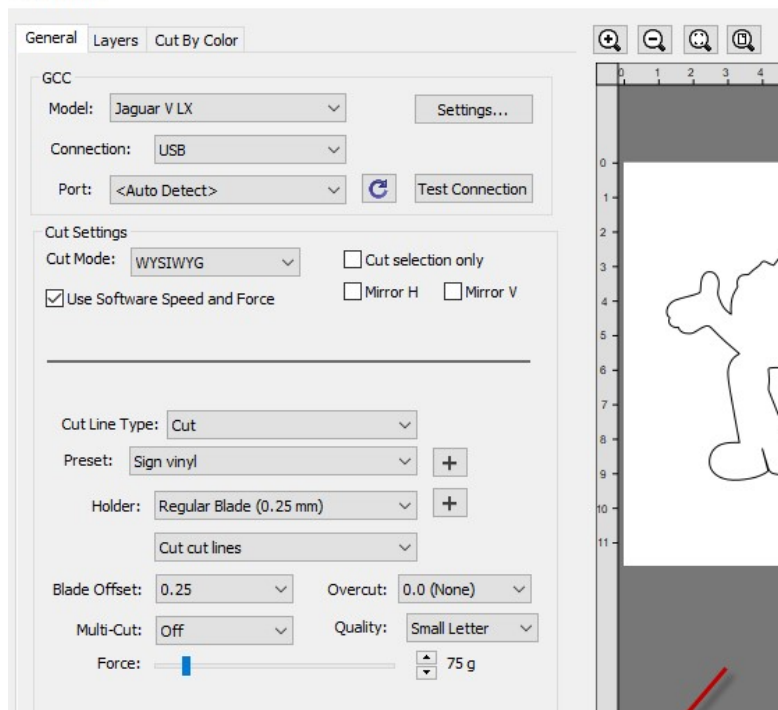

Step11 The process is complete.